

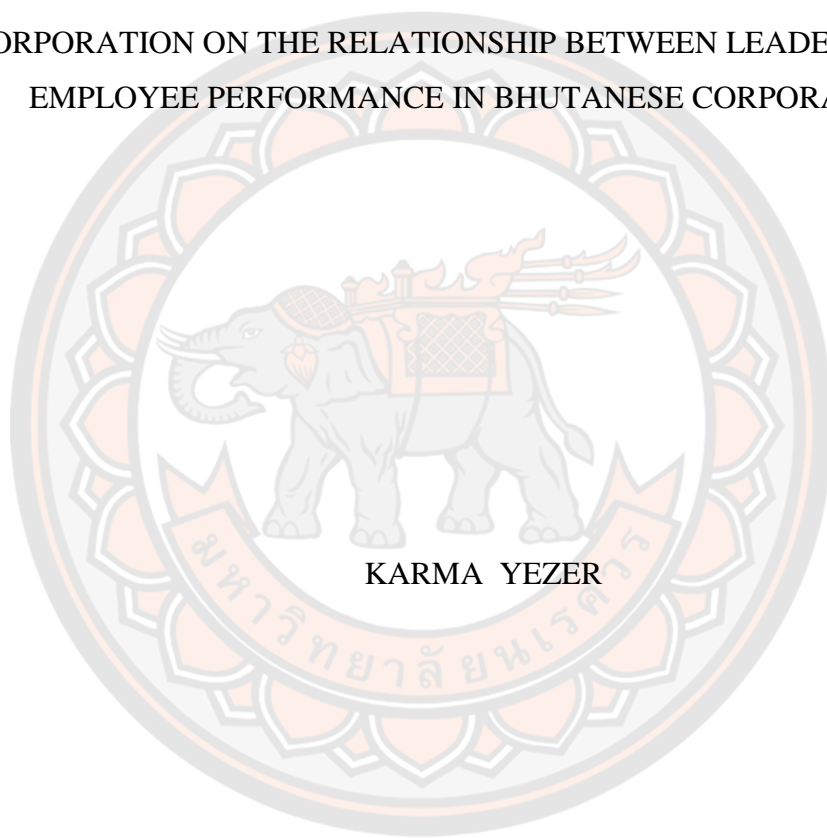

INTERVENING EFFECT OF GROSS NATIONAL HAPPINESS IN  
CORPORATION ON THE RELATIONSHIP BETWEEN LEADERSHIP AND  
EMPLOYEE PERFORMANCE IN BHUTANESE CORPORATIONS



KARMA YEZER

A Thesis Submitted to the Graduate School of Naresuan University  
in Partial Fulfillment of the Requirements  
for the Doctor of Philosophy in Business Administration

2023

Copyright by Naresuan University

INTERVENING EFFECT OF GROSS NATIONAL HAPPINESS IN  
CORPORATION ON THE RELATIONSHIP BETWEEN LEADERSHIP AND  
EMPLOYEE PERFORMANCE IN BHUTANESE CORPORATIONS



A Thesis Submitted to the Graduate School of Naresuan University  
in Partial Fulfillment of the Requirements  
for the Doctor of Philosophy in Business Administration  
2023

Copyright by Naresuan University

Thesis entitled "Intervening Effect of Gross National Happiness in Corporation on the Relationship between Leadership and Employee Performance in Bhutanese Corporations"

By Karma Yezer

has been approved by the Graduate School as partial fulfillment of the requirements for the Doctor of Philosophy in Business Administration of Naresuan University

**Oral Defense Committee**

..... Chair  
(Associate Professor Assadej Vanichchinchai, Ph.D.)

..... Advisor  
(Associate Professor Vichayanan Rattanawiboonsom, Ph.D.)

..... Co Advisor  
(Assistant Professor Warawude Rurkwararuk, Ph.D.)

..... Internal Examiner  
(Fuangfa Panya, Ph.D.)

..... Internal Examiner  
(Associate Professor Katechan Jampachaisri, Ph.D.)

**Approved**

.....  
(Associate Professor Krongkarn Chootip, Ph.D.)  
Dean of the Graduate School

<b>Title</b>	INTERVENING EFFECT OF GROSS NATIONAL HAPPINESS IN CORPORATION ON THE RELATIONSHIP BETWEEN LEADERSHIP AND EMPLOYEE PERFORMANCE IN BHUTANESE CORPORATIONS
<b>Author</b>	Karma Yezer
<b>Advisor</b>	Associate Professor Vichayan Rattanawiboonsom, Ph.D.
<b>Co-Advisor</b>	Assistant Professor Warawude Rurkwararuk, Ph.D.
<b>Academic Paper</b>	Ph.D. Dissertation in Business Administration, Naresuan University, 2023
<b>Keywords</b>	Leadership, GNH in Corporation, Psychological Capital, Employee Performance, Structural Equation Model, Moderation, Intervening variable

### ABSTRACT

This study examines the intervening role of Gross National Happiness (GNH) in Corporation and employee's Psychological Capital on Leadership and Employee Performance in Bhutanese Corporations. Survey data were collected from 511 employees of Druk Holding and Investments Limited (DHIL) and its six owned corporations based on proportionate stratified random sampling. Interview data was also collected simultaneously from the relevant officials of these corporations. The GNH in Corporation and Psychological Capital are tested as parallel mediators, stand-alone intermediaries and as serial mediators through Structural Equation Modelling. Test results reveal that whether as parallel, stand alone or as a sequential, these variables partially mediate the effect of leadership on employee performance. The research conceptual framework was based on the synthesis of existing theories, review of relevant literatures and the identified knowledge gap; and findings from this research extends the current knowledge. Also, some specific findings from this study are relevant for administrators and managers of Bhutanese corporations for their policy decisions.

## ACKNOWLEDGEMENTS

I dedicate this piece of work to my grateful parents, loving wife Chimi Yangdon, and all my caring siblings.

This doctoral degree would not have been successful of my own. I take this opportunity to express my sincere gratitude to all who have directly or indirectly been part of my support system. I feel proud as a recipient of a collaborative scholarship offered through and by Office of the Gyalpoi Zimpon, Bhutan and Naresuan University, Thailand. I always remain indebted to my King and Naresuan University for all the necessary institutional support, and for the financial support in particular. Without this scholarship opportunity, my ultimate academic dream would have been still a distant dream.

At the personal level, the most important individuals behind my academic success are Associate Professor Dr. Vichayanan Rattanawiboonsom and Assistant Professor Dr. Warawude Rurkwararuk. Associate Professor Dr. Vichayanan Rattanawiboonsom has been instrumental in shaping my research from the very initial stage including development of the research topic, research objectives, guiding on review of appropriate literatures and suggesting suitable methodology. In addition to the guidance and inspiration rendered as the Advisor, I am also much thankful to Associate Professor Dr. Vichayanan Rattanawiboonsom for her timely support in verifying and approving my necessary official documents, whenever required, in the capacity of the Dean of the faculty of Business, Economics and Communications (BEC). And Assistant Professor Dr. Warawude Rurkwararukas Co-Advisor has been very professional in providing worthwhile recommendations pertaining to my research. Despite the already busy schedule, he always made sure my work was on track and up to the expected standard. I sincerely thank Dr. Warawude for detailed assessment of my work and constant support.

My academic work is also a result of suggestions from the Ph.D. Progress Report Committee and other external experts. I thank Associated Professor Dr. Sujinda Chemsripong, Dr. Sukij Khorchurklang, Dr. Kritcha Yawised and Assistant Professor Dr. Nalinee Mohprasit for providing valuable feedback and advice as members of the progress committee. And I express special thanks to Associate Professor Dr. Assadej

Vanichchinchai, Dr. Fangfua Panya and Associate Professor Dr. Katechan Jampachaisri for being part of my Thesis Defense Committee members, their necessary recommendations and most importantly approving my thesis; I also owe my gratitude to Associate Professor Dr. Wai Chamornmarn for his insightful and critical comments during my proposal presentation. Not the least, Dr. Sonam Tobgye who currently resides in the United States of America (USA) has been always resourceful, especially in sharing his ideas related to Gross National Happiness and its application in the business. I found him always open and ready to help. And Dr. Sonam Choiden not only supported my academic endeavor as one of the experts but also as the then President of my employer Gedu College of Business Studies, Royal University of Bhutan (RUB). Dr. Saamdu Chetri who is a visiting Professor at various Indian Institutes also managed to find some time in helping me at least during the initial stage of my proposal. I am indebted for all these supports.

I am equally grateful to Mrs. Piyapan Mukphet, Mrs. Thanawan Srisuwan, Mrs. Rungthida Senanak and in fact all the supporting staff of the BEC faculty for their administrative assistance; any official documentation and miscellaneous tasks were made easier due to their unfailing support. Similarly, I am also thankful to Ms. Warangkana Poomjeen, International Relations Officer and the Division of International Affairs and Language Development (DIALD) of Naresuan University as a whole for all the logistical arrangements. For making my data collection easy as a result of institution-to-institution official correspondences, I express thanks to the Human Resources Division, Office of the Vice Chancellor, Royal University of Bhutan. Also Gedu College of Business Studies as the employer have been supportive for the entire duration of my study. All the relevant officials and colleagues of the college supported me in certain way; specifically, I owe Mr. Jamyang Tenzin, Dean of Academic Affairs (DAA) and Mr. Samten Jamtsho, Dean of Research and Industrial Linkages (DRIL) for their immense professional support.

Finally, I would like to express my sincere appreciation to the Druk Holding & Investments Limited (DHIL) and its owned-corporations for their cooperation. I have received full support from both the leadership and employees in the form of facilitation and genuine participations in the survey and interview. Thank you All.

Karma Yezer





## TABLE OF CONTENTS

	<b>Page</b>
ABSTRACT.....	C
ACKNOWLEDGEMENTS.....	D
TABLE OF CONTENTS.....	G
LIST OF TABLES.....	K
LIST OF FIGURES.....	M
CHAPTER I INTRODUCTION.....	1
Introduction.....	1
The Motivations.....	2
GNH Certification and GNH in Corporation.....	5
Scope of the Study.....	6
Research Questions.....	7
Research Objectives.....	8
Summary.....	8
CHAPTER II REVIEW OF LITERATURES.....	9
Outline.....	9
Bhutan in the context of Gross National Happiness.....	9
1. Governance.....	12
2. Economy.....	15
3. Socio-Culture.....	18
4. Environment.....	21
Review of Relevant Literatures.....	23
1. Leadership-History and concept.....	23
2. Scholarly investigation of Leadership theories and application.....	24
3. Corporation and the existing Leadership Concepts.....	26
4. The Concept of Gross National Happiness.....	30



5. GNH in Business and Operational definition of Leadership.....	34
6. Leadership, GNH in Corporation and Employee Performance.....	45
7. Leadership, Psychological Capital, and Employee Outcomes .....	51
8. Employee Personality as Moderating Variable .....	54
Conceptual Framework.....	57
Chapter Summary .....	59
<b>CHAPTER III METHODOLOGY .....</b>	<b>60</b>
Methodology Overview .....	60
Data Collection tools and Measures .....	61
Population and Sampling .....	65
Survey Instrument Validation.....	67
Data Collection .....	68
Data Management.....	70
1. Data File Preparation.....	70
2. Reliability and Validity .....	71
Statistical Tools for data Analysis .....	73
Chapter Summary .....	74
<b>CHAPTER IV RESULT &amp; ANALYSIS .....</b>	<b>75</b>
Content Outline.....	75
Response Rate and Demographic Profile .....	75
1. Response Rate .....	75
2. Respondents' Demographic Profile.....	76
Leadership, GNH and Employee Performance.....	78
1. Leadership .....	78
2. GNH in Corporation .....	82
3. Employee Performance .....	93
4. Psychological Capital and Personality .....	99
Structural Equation Model (SEM).....	103
1. Steps in conducting SEM. ....	103

2. Model Parameter Estimation .....	104
3. Composite Reliability and Construct Validity .....	104
4. Model Fit Assessment .....	107
5. Analysis of Measurement Models .....	107
6. Analysis of Structural Model .....	122
7. Intervening variables: GNH in Corporation and Psychological Capital .....	128
8. Moderation Effect of Employee Personality .....	135
9. Summary of Quantitative Findings .....	141
Deconstruction of Interview Data.....	143
1. Interpretation of GNH in Corporation.....	144
2. Bhutanese Corporations and application of GNH.....	150
3. Leadership in Bhutanese Corporations.....	161
4. Leadership, Psychological Capital, Personality and Performance .....	165
5. Personality, Happiness, and Job satisfaction.....	177
Summary.....	179
CHAPTER V DISCUSSION AND CONCLUSION .....	180
Outline .....	180
Leadership and its consequences in Bhutanese Corporations .....	180
The Findings and the existing Knowledge .....	183
Decoding Leadership in the Corporations .....	186
Making sense from GNH in Corporations.....	187
Discussion of Employee Performance in Corporations.....	192
Take from Psychological Capital and Personality .....	194
Contribution and recommendations of the Study .....	196
1. Practical Contribution.....	196
2. Theoretical Contributions.....	198
Limitation of the study and directions for future research .....	200
Conclusion .....	201
REFERENCES .....	203

APPENDIX.....222  
BIOGRAPHY .....249



## LIST OF TABLES

	<b>Page</b>
Table 1 Information on GDP per capita and HDI for selected countries.....	10
Table 2 Leadership Dimensions.....	40
Table 3 Sample size distribution among the Companies .....	67
Table 4 Response Rate.....	76
Table 5 The overall respondents' profile: Sex and Position level .....	76
Table 6 Respondent's demography by Corporation .....	77
Table 7 Post hoc comparison of leadership dimensions by Respondent Position .....	79
Table 8 Position wise Perception of Leadership.....	80
Table 9 Leadership Category .....	82
Table 10 GNH in Corporation & Happiness Score by Corporation .....	84
Table 11 GNH and Happiness Scores by Position Level .....	85
Table 12 Short term Training and long-term Studies availed.....	86
Table 13 Overall Corporate Values .....	88
Table 14 Corporation wise mean scores of corporate values .....	89
Table 15 One-way ANOVA result for Health & Safety among Corporations .....	90
Table 16 post-hoc test summary for 'Health & Safety' .....	90
Table 17 Domain wise Sufficiency gradient of indicator scores .....	91
Table 18 Happiness gradient based on number of sufficiency domains.....	92
Table 19 Corporation wise Mean values of employee performance .....	94
Table 20 ANOVA Test result for Performance by Corporations .....	95
Table 21 post-hoc test summary of Performance by Corporations.....	96
Table 22 post-hoc test summary of Performance by Position Level .....	97
Table 23 Corporation wise actual performance scores .....	98
Table 24 Descriptive statistics for Psychological Capital by sex .....	99
Table 25 The t-test result of Psychological Capital Means by Sex .....	100
Table 26 Personality traits by position level.....	103

Table 27 Convergent Validity & Composite Reliability of first factors.....	110
Table 28 Summary of Model Fit Statistics of individual measurement models.....	115
Table 29 The Composite Reliability based on the CFA .....	116
Table 30 Convergent Validity: Leadership and Psychological Capital .....	117
Table 31 Convergent validity: GNH in Corp and Employee Performance .....	118
Table 32 Discriminant Validity based on Fornell-Larcker Criterion.....	119
Table 33 Average monotrait correlations .....	121
Table 34 HTMT values of the construct .....	121
Table 35 Simplified HTMT table .....	122
Table 36 Model fit statistics for Structural Model.....	124
Table 37 Regression weights and significance value .....	125
Table 38 Hierarchical multiple regression model summary .....	126
Table 39 ANOVA table of hierarchical multiple regression model .....	126
Table 40 Hierarchical multiple regression model coefficients .....	127
Table 41 The intervening effect of multiple mediators .....	129
Table 42 Estimates of relationships where GNH in corporation is a mediator .....	131
Table 43 Intervening effect of GNH in Corporation .....	131
Table 44 Estimates of relationships where Psychological Capital is a mediator.....	133
Table 45 Intervening Effect of Psychological Capital.....	133
Table 46 Estimates of series of relationships.....	134
Table 47 Serial Mediation Result .....	135
Table 48 Moderation effect of Personality as composite variable.....	137
Table 49 Personality traits on Leadership and GNH in Corporation.....	138
Table 50 Personality traits on Leadership and Psychological Capital.....	139
Table 51 Moderation of Personality traits between Leadership and Performance ...	140
Table 52 Result of Moderation Probing of Open-mindedness and Neuroticism.....	141
Table 53 Summary of hypothesis test outcome .....	142

## LIST OF FIGURES

	<b>Page</b>
Figure 1 Proposed Conceptual Framework.....	58
Figure 2 Overall Mean values of GNH Domains .....	83
Figure 3 Incidences of Sexual harassment.....	87
Figure 4 Sleeping hours .....	88
Figure 5 Proportion of employees in each performance band .....	98
Figure 6 Descriptive statistics of Psychological Capital by Position Level .....	101
Figure 7 Overall Mean Values of Personality Traits .....	102
Figure 8 Measurement Model 1: First Factor CFA for Leadership Variable .....	109
Figure 9 Measurement Model 2: Second Factor CFA for Leadership Variable.....	111
Figure 10 Measurement Model 3: CFA of GNH in Corporation.....	112
Figure 11 Measurement Model 4: CFA of Psychological Capital.....	113
Figure 12 Measurement Model 5: CFA of Employee Performance .....	115
Figure 13 Correlation matrix of variables for HTMT calculation .....	120
Figure 14 Structural Equation Model .....	123
Figure 15 Parallel Mediation Model .....	128
Figure 16 Separate Mediation Model 1: GNH in Corporation as mediator.....	130
Figure 17 Separate Mediation Model 2: Psychological Capital as mediator.....	132
Figure 18 Serial Mediation Model.....	134
Figure 19 Personality as moderator for Leadership and Performance.....	136
Figure 20 Personality as moderator for Leadership and GNH in Corporation.....	136
Figure 21 Personality as Moderator for Leadership and Psychological Capital.....	137



# CHAPTER I

## INTRODUCTION

### Introduction

If the model of measuring progress in terms of Gross Domestic Product (GDP) and Gross National Income (GNI) is perfect, the economically richer countries should be happier. The truth is countries with higher GDP do not always translate into higher equality in terms of peace, prosperity, and happiness. For instance, Bertolucci (2018) based on the regression estimates of United Nations data, noted that a one percent change in GDP per capita results only 0.3 unit change in happiness (anchored from 0 to 10), while other variables such as social support, life expectancy, freedom to make life choices, generosity and freedom from corruption, in addition to GDP are factored in, almost 75% of variance in happiness could be explained. Stiglitz et al. (2009) who were tasked to study the limitation of current statistical information based on GDP also reported that time has reached to shift the measurement system from emphasising production to people's well-being. Interestingly, some decades ago, as an alternative to economic model, Gross National Happiness (GNH) as a more holistic and sustainable approach to development was already conceived in Bhutan (GNH Centre, n.d).

One of the principles of Bhutan's state policy is that "the State shall strive to promote those conditions that will enable the pursuit of Gross National Happiness" (*The Constitution of the Kingdom of Bhutan*, 2008). As a national development framework, GNH is expected to be operationalised in every aspect of policy and decision making at least in Bhutan, whether it is governmental, non-governmental or business and corporate sectors. It is particularly important in guiding business corporates which are involved in making profits. The alignment and application of GNH could induce employee wellbeing and happiness thereby enhancing their psychological positivity. It is only natural that this in fact can fuel employee performance. There are enough patterns and trends in the existing literatures that workplace happiness boosts employee psychological capital and their performance;



happiness and wellbeing are crucial aspects of GNH. Thus, the leaders, policymakers, government officers, business executives and managers have important stake in creating GNH society in addition to their core mandates. Leadership matters for the holistic development by instilling well-being in any types of organisations. Ultimately, any policies and systems should contribute societal development and common welfare. GNH in business and corporations is important as it can make huge impact to the society for harmonious interdependence as well. In fact, GNH induced business should result in better Employee Performance and business sustainability in the long run. Having felt necessary to connect GNH and Business the theme for the Seventh International Conference on Gross National Happiness organised by Centre for Bhutan Studies and GNH (CBS) held in November 2017, was “GNH of Business”. The study of Leadership in business corporations and its relationship with Employee Performance and how GNH values are applied in workplace and business ecosystem have become timely for the necessary interventions and guidance at policy, practice, and action levels.

### **The Motivations**

According to Centre for Bhutan Studies & GNH (2018), “Gross National Happiness has been operationalized at governmental level but not at business level”. Sebastian (2015) also notes that the government and civil service leaders were not certain whether business and corporate leaders appreciate and apply the concept of GNH in their business conduct. Former Prime Minister of Bhutan (2013-2018), Tobgay (2018), through his Keynote address to the 7<sup>th</sup> International Conference on *Gross National Happiness (GNH of Business)* expressed that the economic benefits of current business model are often skewed towards a limited section of society whereby income inequality levels have resulted historically high. Thus, leadership in business has inevitable role in creating equitable, harmonious, and sustainable society with shared gains, and in particular, harmony within the organisations. In general, business without embedding GNH values would continue to be driven by profit maximisation motives, which would only help improve owners and shareholders at the cost of environment and society. The achievement of the ultimate national goal would be at stake devoid of GNH values in business. Accordingly, the Centre for Bhutan Studies

& GNH periodically organises GNH proceedings and conferences. The Centre has also developed the framework of GNH Certification for business organisations as an outcome of the seventh International GNH Conference. The leadership in each business determines the business systems and its approach. Brown and Treviño (2006) claims that ethical leadership is a result of the moral person who values integrity and fairness, treat people well and make ethical decisions. An ethical leader is perceived to be honest, trustworthy, show concern for people around and stakeholders. On the other hand, there are many cases of corporate stories worldwide on how unethical leadership puts organisation at stake. Enron's accounting fraud and scandals, Panama papers which implicated heads of government for evading taxes, Volkswagen's emission scandals are some that leaders can draw the lessons from. The GNH in business and corporation, and its characteristics should be exuded by individual business leader.

Leadership is the paramount factor for organisational direction and systems it adopts; for instance, leadership can determine the degree of GNH infused business, employee's psychological capital and employee performance. However, there is only scanty research conducted on business leadership in Bhutan, let alone on the association of Leadership, GNH in Corporation, Psychological Capital, and Employee Performance. Hence, Leadership in Business and its alignment of GNH is yet another important topic that needs assessment. To estimate the trend of the study on leadership in Bhutan and its impact especially in business and corporate setting, the academic articles were explored using Google Scholar database. Among the first 500 articles searched and screened using relevant keywords, only 23 articles relate with the business leadership in Bhutan. Of course, the result of data search is as of June 2021 and the figure is subject to change if search is extended using more databases. The highest citation received was 13 for one article indicating that leadership study in Bhutan is yet to attract interest in the academic sphere even though the 'Gross National Happiness' has fascinated both academics and practitioners going by the plentiful and thorough academic discourses. What is noteworthy is that only 4 publications among those 23 articles, were about leadership in business, and the rest of the research articles either focussed on academic leadership or general leadership.

There are also conclusive evidences that those articles were published mainly for the fulfilment of academic requirement for the award of academic degree.

To set the context straight, a newspaper journalist Rinzin (2020, April 11) reported that the Royal Audit Authority during compliance auditing has found one well known financial company in Bhutan recruited applicants who submitted forged documents. This lack of proper scrutiny system has deprived genuine applicants. It can be assigned to weak leadership in the organisation which led to the disequilibrium in their recruitment and selection system. This resulted in the huge financial loss of the organisation in unnecessarily paying retirement benefits after the management required those employees to compulsorily retire beside other consequential losses. Wangchuk (July 8 2017) also alerted the nation that the Anti-Corruption Commission of Bhutan (ACC) suspended top executives of one of the Bhutanese Public Insurance Companies for colluding with vendors in the investment of its fund. Similar news is often heard although leadership carries their organisational brand in the social sphere and public eyes.

Going by the annual reports published by Royal Audit Authority of Bhutan in the last five years, it is alarming to note that the irregularities kept on increasing from Nu (Nu is a symbol of Bhutanese Currency, Ngultrum; Ngultrum (Nu) and Indian Rupee (₹) is 1:1 peg). 407.112 million in 2017 to Nu.604.380 million in 2018 to Nu. 1415.153 million in 2019. By 2021, the unresolved observation touched Nu. 4002.448 million, a whopping increase of more than 51 percent from 2020 which noted a gap of Nu. 2,051.233 million. The more surprising pattern is that the irregularities due to fraud, corruption and embezzlement do not seem to decrease. In fact, it jumped from Nu. 8.227 million in 2017 to Nu. 29.612 million in 2018 and increased to Nu. 31.912 in 2019. In 2020 it has decreased to Nu. 26.167 (must be due to lack of economic activities because of Covid-19 pandemic) but has increased again to Nu.133.006 million in 2021. Although Anti-Corruption Commission of Bhutan (2019) concluded that the Leadership integrity (which measures integrity, ethics, trust, transparency, accountability, and fairness) among the public agencies as satisfactory with a score of 7.82 (out of 10), the annual Audit report reflects alarming shortfalls amount of Nu. 3869.442 million, due to mismanagement (non-compliance, shortfall and lapses) alone (Royal Audit Authority of Bhutan, 2021). Hence, the leadership and conduct of

governance whether in public offices or business should be guided by basic principles, ethics, and values.

### **GNH Certification and GNH in Corporation**

It is highly likely that the GNH in Corporation as a variable may create fair amount of doubt and scepticism in readers, especially Bhutanese audience that this topic seems redundant and duplication of what was already tabled by Centre for GNH and Bhutan Studies as a process of certifying business organisations. The current methods of current study, however, is not the replication of GNH Certification framework. The point is, even though the basic concept may be identical at fundamental level, the current research bears distinctive characteristics in many aspects. Although, there is already a framework to measure GNH of business for certifying business organisations, the present study had its own model of ‘GNH in Corporation’ which is different in terms of data collection tool and analysis. This study is more academic where the model was developed based on the concept of GNH through extensive academic literatures. The purpose of this very study was independent, and different from the GNH certification framework. While the certification framework developed by Centre for Bhutan Studies & GNH is aimed for formal periodic assessment of business organisations, the current research was not at all indented for annual compilation. Also, the difference lies in the readership; while the Certification report can be exclusively for the government and the businesses for the immediate intervention, the report from this research is aimed for the academics worldwide in addition to management and employees of DHI owned corporations. The format bears significant distinction, as the Certification report may be published in the form of descriptive report, the final output from this study, however, is analytical and relational among the identified dimensions, and most significantly with other variables of interest. Thus, the GNH in Corporation construct for this study is a deviation from the GNH Certification framework.

The GNH Certification framework developed by Zangmo et al. (2018) contains 56 indicators. The certification model is an arrangement of long comprehensive list of both subjective and objective indicators. On the contrary, this research study was based on limited but all-encompassing indicators comprised of

survey items. However, the essence of GNH was not diluted but considered contextualising the concept in business and workplace setting. The broad factors of business corporations in terms of their governance, economic contribution, promotion of socio-culture, implementation of environmental concerns, and workplace happiness were examined. The basic difference that this research entails would be in terms of the indicators and the angle of approach as well. The indicator items were developed taking business context into consideration based on the Royal Vision, the overall national policy, expert opinions and analysis of corporate core values. Most significantly, the relevant documents such as Stiglitz-Sen-Fitoussi report on measurement of economic performance and social progress, UN Sustainable Development Goals, academic literatures on responsibilities and accountabilities of the business, for example, in the form of corporate social responsibility, workplace happiness and employee well-being formed the fundamental basis for the conception and development of GNH in Corporation variable.

Thus, considering lack of similar research being conducted on one hand, and the significance of Leadership in business on the other hand, this study was intended to explore the status of leadership (based on the Leadership Framework developed by researcher), Psychological Capital, Employee Performance and the GNH of Business in Bhutanese Corporations. Importantly, the associations and intersections among these variables were investigated for statistical significance.

### **Scope of the Study**

The study is based on analysis of data and opinions provided by employees of Druk Holding and Investments Ltd (DHIL) and six of its owned companies. DHIL is a public company registered under the Companies Act of Bhutan (2016). This, commercial arm of the Royal Government of Bhutan is responsible “to hold and manage the existing and future investments of the Royal Government for the long-term benefit of the people of Bhutan” (*Royal Charter for Druk Holding and Investments*, 2008). According to the annual report of the Druk Holding & Investments Ltd (2020) there are total of 21 DHIL Portfolio companies [9 DOCS; 4 DCCs and 7 DLCs]. The pattern of DHIL ownership of these companies are as follows: DHI Owned Companies (100% ownership and abbreviated as DOCS); DHI



Controlled Companies (With ownership of 51-80%, abbreviated as DCCs) and DHI Linked Companies (Less than 51% Shareholding, abbreviated as DLCs).

Although only nine owned out of the total DHI portfolio companies, most of the contributions in terms of profit or income and tax are from these DOCs. For instance, the total income from these companies alone makes 70.9 % in 2015 and 85.5% in 2019, of the total DHI income. Going by the trend, the income contribution increases annually. Hence, the DHI owned companies are chosen to represent the Bhutanese corporations for this study. Another criterion put for the selection of corporations for study is the incorporation year; only those DHI owned companies incorporated earlier or in the year 2010 are considered. This is because, 2010 is taken as baseline for study considering the maturity of the organisations. And it is logical that these corporations generalise other companies as they operate under the same Companies Act. In fact, it is important to clarify that, these corporations are not unit of analysis themselves but those employees working under them.

Based on the data collected from employees of these corporations, the intervening role of GNH in Corporation and Psychological Capital on the link between Leadership and employee performance is examined using the Structural Equation Modelling.

## **Research Questions**

### **Overall Research Question:**

Will GNH in Corporation and Psychological Capital mediate the effect of Leadership on Employee Performance?

### **Sub-questions**

1. What is the status of leadership and GNH in Bhutanese Corporations?
2. What can be inferred from Employee Performance data of Bhutanese Corporations?
3. Is Employee Performance is influenced by Leadership?
4. Is Leadership a significant predictor of GNH in Corporations and Employee Psychological Capital?
5. Can GNH in Corporation effect Employee Psychological Capital?

6. Does Employee Personality moderate the relationship between Leadership and Employee Performance; Leadership and GNH in Corporation; and Leadership and Psychological Capital?

### **Research Objectives**

#### **The main objective:**

To examine if GNH in Corporation and Psychological Capital intervene the relationship of Leadership and Employee Performance

#### **Sub-Objectives:**

1. Assess the status of the Leadership and GNH in Bhutanese Corporations
2. Evaluate the Employee Performance of Bhutanese Corporations (DHI owned Companies)
3. Investigate the influence of Leadership on Employee Performance
4. Investigate the influence of Leadership on GNH in Corporation and Psychological Capital
5. Assess the influence of GNH in Corporation on Psychological Capital
6. Evaluate moderation effect of Employee Personality in the relationship of Leadership and Employee Performance; Leadership and GNH in Corporation; and Leadership and Psychological Capital

### **Summary**

This chapter introduces the concept of Gross National Happiness (GNH) as an alternative multidimensional framework which measure development and progress. The rationale for Bhutan adopting and prioritising this approach over Gross Domestic Product (GDP) is elucidated. This is followed by the expression of importance of leadership in implementation of the GNH principles in their respective organizations; the instances of consequences of leadership failures, findings of auditory agency on corruption, fraud and embezzlement in the public organizations are also highlighted to ascertain the leadership role. Although, GNH is expected to be operational in every sphere of governance in Bhutan, it is believed that they are yet to be fully integrated and put into practice in the business and corporate sectors. Accordingly, this chapter points out the motivation, basis, objective, scope, and direction of the study.



## **CHAPTER II**

### **REVIEW OF LITERATURES**

#### **Outline**

This chapter is presented in two main sections namely 'Bhutan in the context of Gross National Happiness' and 'Review of Relevant Literatures'. Although the first section may not have direct connection with the study objective per se, it is, however, discussed for a contextual reference. Bhutan is introduced through its development philosophy of Gross National Happiness, especially in terms of its four pillars of good governance, sustainable socio-economic development, preservation and promotion of culture, and environmental conservation. Reader has the option to skip the first section altogether and instead proceed to the next section which is exclusively related to the present study. The second section 'review of relevant literatures' is the essential part of the chapter which connects the research objectives, operationalisation of variables and development of conceptual framework.

#### **Bhutan in the context of Gross National Happiness**

Bhutan is one of the 193 United Nations (UN) member states as of April 2021. However, the year in which Bhutan was approved of its membership is notably interesting. According to the record maintained by United Nations (n.d), in 1971, a total of five sovereign states namely Bahrain, Bhutan, Qatar, Oman and United Arab Emirates (UAE) were added to the UN membership list. This is interesting, because these nations share one common aspect of governance; all these countries represent certain degree of monarchical leadership and influence. In the following, Bhutan is introduced by way of comparing with these middle east nations and its southeast Asian neighbours. Introduction of Bhutan by way of comparing with these nations does not bear any ill intention though.

The UAE follow Federal and Elective Monarchy (each federation or emirate is governed by a hereditary Sheikh and one among them is elected as the President to lead the collective federation) and Oman's system of government is Sultani (Royal), hereditary in the male descendants of Sayyid Turki bin Said bin Sultan ("The Basic

Statute of the State," 1996). Qatar and Bahrain have Unitary semi-constitutional monarchy and Unitary Constitutional Monarchy respectively. Bhutan is a Sovereign Kingdom with Democratic Constitutional Monarchy as the form of government (*The Constitution of the Kingdom of Bhutan*, 2008). Among the other commonalities, Bhutan and UAE shared one fundamental agenda of 'happiness' exuded through structured institutions; in 2016 UAE created a post of Minister of State for Happiness (lasted at least till 2020) while Bhutan has Gross National Happiness Commission (GNHC) mandated for national socio-economic development guided by the principles of GNH.

There are certain differences as well; all these Arab nations joined the United Nations in the same year that they gained independence from the British Empire while Bhutan was never under any colonial control although the British influence cannot be ruled out. Also, the notable difference lies in their level of economy and Human Development Index. The following pieces of information in the table are based on 2019/2020 records and can change annually.

**Table 1 Information on GDP per capita and HDI for selected countries**

Country	GDP per capita (Current US\$) 2019/2020	HDI/HDI World ranking
Bahrain	23503.977/NA	0.582 (ranked 42 <sup>nd</sup> ),
Oman	15343.062/NA	0.813 (ranked 60 <sup>th</sup> ),
Qatar	62,088.062/50805.463	0.848 (ranked 45 <sup>th</sup> )
UAE	43,103.323/NA	0.890 (ranked 31 <sup>st</sup> )
Bhutan	3,316.176/3122.376	0.654 (ranked 129 <sup>th</sup> )
Maldives	10,626.513/7455.855	0.740 (ranked 95 <sup>th</sup> )
Sri Lanka	3,853.084/3682.038	0.782 (ranked 72 <sup>nd</sup> )
India	2,099.599/1900.706	0.645 (ranked 131 <sup>st</sup> )
Bangladesh	1,855.691/1968.792	0.632 (ranked 133 <sup>rd</sup> )
Pakistan	1,284.702/1193.733	0.557 (ranked 154 <sup>th</sup> )
Nepal	1,071.051/1155.1428	0.602 (ranked 142 <sup>nd</sup> )
Afghanistan	507.103/508.808	0.511 (ranked 169 <sup>th</sup> )

**Source:** the table was created by the author based on the GDP data of World Bank and HDI data of UN Human Development Reports

The GDP per capita (Current, US\$) as of 2019 for Bahrain, Oman, Qatar and UAE stand at \$23,503.977, \$15,343.062, \$62,088.062 and \$43,103.323 respectively against Bhutan's \$ 3316.176. However, Bhutan retains top three rank in terms of GDP per capita at least among eight Asian Association for Regional Cooperation (SAARC) countries with only Maldives (\$10,626.513) and Sri Lanka (\$3853.084) ahead. The GDP per capita of India, Bangladesh, Pakistan, Nepal, and Afghanistan are \$2,099.599, \$1855.691, \$1,284.702, \$1071.051 and \$507.103 respectively (World Bank). Similarly, all the other four nations who joined UN in the same year as Bhutan have differences in terms of Human Development Index (HDI). The HDI values for Bahrain, Oman, Qatar and UAE are 0.582 (ranked 42<sup>nd</sup>), 0.813 (ranked 60<sup>th</sup>), 0.848 (ranked 45<sup>th</sup>) and 0.890 (ranked 31<sup>st</sup>) respectively. On the other hand, Bhutan is placed 129<sup>th</sup> with HDI value of 0.654. However, again, only Sri Lanka (with 0.782 and ranked 72<sup>nd</sup>) and Maldives (with 0.740 and ranked 95<sup>th</sup>) are ahead of Bhutan among the SAARC nations indicating that Bhutan is comparatively faring better; the score for India, Bangladesh, Nepal, Pakistan and Afghanistan's HDI stand at 0.645, 0.632, 0.602, 0.557 and 0.511 in the decreasing order of the ranking (United Nations Development Programme, 2020).

Bhutan is a mountainous landlocked nation with total area of 38,394 km<sup>2</sup>, and 70% of the total land is covered by forest (National Statistics Bureau, October 2020). Despite the fact that Bhutan's Carbon dioxide (CO<sub>2</sub>) emission (metric tons per capita) is mere 1.71 against the world's 4.56 (World Bank, 2021), Bhutan's forest absorbs carbon dioxide more than it produces, making it the Carbon Sinking country instead (Climate Council, 02 April 2017). By the way, it is mandated that "the Government shall ensure that, in order to conserve the country's natural resources and to prevent degradation of the ecosystem, a minimum of sixty percent of Bhutan's total land shall be maintained under forest cover for all time" (*The Constitution of the Kingdom of Bhutan*, 2008). In terms of size, many assume Bhutan to be very small. This is only relatively true. According to Phuntsho (2013) "one can be surprised that there are nearly a hundred other independent and semi-independent countries, which are smaller than Bhutan and Bhutan's position in global ranking in size is about 134 out of 233, next to Switzerland and the Netherlands." The surface areas of Switzerland and Netherlands are 41291 km<sup>2</sup> and 41542 km<sup>2</sup> respectively (UN data).

Indeed, the fact that Bhutan has India in the south and China in the north as big, powerful, and immediate neighbouring countries may be a strong factor for the formation of relative impression of Bhutan being seen as tiny nation. Mathematically, India is more than 85 times Bhutan's surface area while China is 250 times size of Bhutan. But Bhutan is known to the outside world through the concept of Gross National Happiness (GNH) as the middle path development policy she pursues. The GNH can be understood in terms of four broad focus areas called GNH Pillars which include (a) Good Governance, (b) Sustainable and Equitable Socio-Economic Development, (c) Environmental Conservation, and (d) Preservation and Promotion of Culture. The following paragraphs portray the details of Bhutan within the context of GNH.

### **1. Governance**

The profound magnitude in terms of depth and breadth of good governance in Bhutan can be traced back to the Legal code known as *Kathrim* (འགྲུབ་ཁྲིམས་) of 1729 which specifies that “if the government cannot create happiness for its people, then there is no purpose for government to exist”. The legal code was documented for the first time by the 10<sup>th</sup> Je Khenpo Tenzin Choegyal, based on the legal legacy of Zhabdrung Ngawang Namgyal. According to a History textbook prescribed for Bhutanese School syllabus (Class-IX), Zhabdrung was born in Tibet in 1594 into the princely family of Gya who ruled the Drukpa Kagyupa School, and responsible for unifying Bhutan as a nation state. The current modern world power, the United States of America (USA), the country that today represent democracy, economic prosperity, military power and advanced technology, was almost five decades far from its existence as an independent nation-state by then. In retrospect, it can be noted that in 1729, one of the to-be-renowned philosophers was just growing up; Jean-Jacques Rousseau, a Swiss French thinker turned 17 who would later become well known for his influential work *The Social Contract* (1762). This trilogy of references is intended simply to estimate the direction of governance in particular period among three different systems far apart.

Bhutan's governance can be understood in terms of three phases of the transformational time frame: Pre-1907, the Dual System period of governance between 17<sup>th</sup> and 20<sup>th</sup> centuries [of course Bhutan existed as independent entity long

before 17<sup>th</sup> century]; from 1907 till 2008 as 20<sup>th</sup> century extraordinary Kingship, and the 21<sup>st</sup> century governance system of Parliamentary Democratic Monarchy after 2008. The early first phase is significant for shaping and solidifying Bhutan into a single entity in the form of nation state by the Zhabdrung. The most notable attribute of this phase of time was the civilisation of the society through law and order. The peace and happiness continued for a few more centuries under the dual system rule of subsequent Desis (who had civil administrative authority) and Je khenpos (who had public influence through legitimatised spiritual leadership) until the internal situations arising out of opposing factions contesting for power could not be controlled. Consequently, the people and clergy together elected and vested trust and authority in the manifested able leadership of Sir Ugyen Wangchuck, through a significant historical binding social contract crowning him the first hereditary King of Bhutan in 1907. In recognition of the role played by the then Trongsa Penlop Ugyen Wangchuck in negotiating win-win treaty which could be signed by British and Tibet at Potala Palace on September 7, 1904, he was presented the insignia of the Knight Commander of the Indian Empire (KCIE) by the British. This earned him the title “Sir”.

This transition of governance marks the unprecedented time in the form of excellence in national governance; more than anything, the first two monarchs will be always respected for their role in maintaining independence of the country for generations to come; the vision of successive kings could be felt and experienced in the context of modern development through people-centered policy. For instance, among the 11 resolutions taken during its 11<sup>th</sup> session of the national assembly held in 1957, construction of motorable road from Indo-Bhutan border with each district to contribute uniform labour was decided. This marks the modern Bhutan. The first national assembly was established by the Third King, Druk Gyalpo Jigme Dorji Wangchuck in 1953 comprised of members representing people, monastic body, and government. The clear governance roles by the monarch are separation of power among law making legislature (National Assembly), judiciary and executives (Council of Ministers). Decision making had been taken to grass root in the form of Dongkhag Yargay Tshodu in 1981 and, and Gewog Yargay Tshogchung in 1991. All these systems are the solid foundation for the democracy later. Their leadership



manifested through initiation and decision to join the international community at the right time is an immeasurable assurance for the peace, prosperity, and sovereignty of the nation. Bhutan is a member of important international organisations such as United Nations, South Asian Association for Regional Cooperation (SAARC), and Non-Aligned Movement (NAM). More than any title or description, the Fourth Druk Gyalpo, Jigme Singye Wangchuck will be known and remembered as the architect of modern democracy in Bhutan while the fifth King is already known as 'People's King'.

At the outset, Bhutan is interpreted and taken at face value as young democracy by the outside world. This may be inaccurate. Although officially became democracy only in 2008 with signing of the constitution by the first democratically elected parliament, the practice of democratic governance was already in practice long ago. However, the crucial aspect of formal democracy is the provision of the systematic check and balance for the democratically elected government through relevant institutions. The media is becoming more creative in informing the public, while the constitutional offices such as anti-corruption commission is becoming ever inquisitive of unethical corrupt practices. The judiciary is becoming courageous in deciding the case based on the rule of law. The fact is as stated, understanding Bhutanese democracy as young is untrue; this can be well reflected and understood through voting pattern of the commons. In three elections so far held in 2008, 2013 and 2017, three different political parties were voted consecutively to govern clearly indicating that the citizenry can thoughtfully exercise their voting rights; This conveys two meanings: either the previously elected governments did not live up to public expectations or the public simply wanted to test each new government. By comparison, it is noteworthy that only 11 incumbent American Presidents since 1789 were unsuccessful in re-election thereby not being able to continue the second term. This information is as of 2020.

One common aspect of any form of Bhutanese governance is the pursuit of 'happiness' for the served commons. From the Zhabdrung's dual system to Monarchy to democracy, 'happiness' as a public good is an end pursuit for the governments. However, the conception of well-articulated, systematic, and measurable concept can be credited to the visionary monarch, the Fourth King of

Bhutan. Today, there are four political parties registered with the Election Commission of Bhutan, and their principles and mottos are not totally different from each other. These are democracy in pursuit of ‘equity and justice’ (Druk Phuensum Tshogpa), ‘unity, stability, prosperity’ (People’s Democratic Party), ‘narrowing the gap’ (Druk Nyamrup Tshogpa), and a ‘self-reliant Bhutan’ (Bhutan Kuen-Nyam Party).

## **2. Economy**

In six decades since the Five-Year Development Plan was initiated (1961 to 2019), Bhutan’s Gross Domestic Product has increased by 67 times, at least in face value, without considering any economic factors. Taking Indian Rupee (₹) as the basis and calculated considering inflation, it is surprising to note that the Bhutanese GDP per capita at \$51 (estimated) in 1961 should be of equal value of \$ 3445.18 in 2019. Since the value of Bhutanese Ngultrum (Nu) is pegged at equal value with Indian Rupee (₹), this purchasing power parity was calculated using the currency value of the later. In 1960, Bhutan did not have currency instrument. The actual GDP per capita in 2019 was \$ 3441.94 as per the National Statistical Bureau of Bhutan indicating that even after almost sixty years, Bhutan seems to have rough ride keeping pace for economical race. This must be just the case of accounting mistake or lack of real data. However, while the comparison is made keeping the \$551 of 1999 (by then the GDP figure has become accurate) as the baseline data, in two decades the real positive economic advancement could be ascertained in the excess amount of more than \$1300 GDP per capita from what was expected; the purchasing power of \$551 in 1999 equals \$1946.32 in 2019 while Bhutan’s GDP per capita has touched almost \$3500. Indeed, Bhutan is developing with commendable speed.

Most significantly, Bhutan, based on milestone achieved so far and confidence to fulfil the criteria, the United Nations General Assembly Resolution A/RES/73/133 adopted on 13 December 2018, decided that Bhutan shall graduate from the Least Developed Country (LDC) to the Developing Country (DC) status by December 2023. To graduate from the LDC category is to meet any two of the three threshold criteria: Gross National Income (GNI) per capita, Human Assets Index (HAI) and Economic Vulnerability Index (EVI) in two consecutive triennial reviews. As per the UN’S Committee for Development Policy (CDP) report, Bhutan’s GNI per



capita is estimated at \$ 2,982 in 2021 way above the requirement threshold of \$ 1,222. This indicates that Bhutan is moving ahead of several Asian countries including Afghanistan, Cambodia, Laos, Myanmar, and Nepal, in terms of the development definition purview of United Nations.

Indeed, the decreasing poverty rate within the national population over the years is a full proof of development. According to the National Statistics Bureau (2017b), the overall poverty was brought down to 8.2 % in 2017 from 12% in 2012, while poverty in 2007 stood at 23.2% which again was a big reduction from almost 32 % in 2003. In terms of the equitable socio-economic development, it is well taken care of through the planning and policy measure. For instance, Gross National Happiness Commission (2019) specified how the budget at grass root level is distributed; the gewog\* level capital allocation for the five-year plan (2018-2023) is determined by population (15%), GNH Index (10%), farming (15%), health (20%), education (5%), poverty (15%) and transportation/distance (20%). This formula makes sure that the least developed gewog which has more poverty, hygiene issue, unhappy inhabitants, farming land size and requiring motorable roads get big share of the capital outlay. Similarly, the Dzongkhag (District) level budget is assigned based on economy (40%), GNH index (15%), Health (10%), Education (10%), Culture (10%) and Environment (15%). These are but for the equitable socio-economic development. (\*Gewog is a sub-division of Dzongkhag (District). According to 'The Local Government Act of Bhutan 2007', each Dzongkhag shall be divided into several Gewogs. A Gewog shall be made up of several Chiwogs. A Chiwog may comprise of several villages.)

However, more than interesting truth is some tourists surprise themselves realising that Bhutan does not serve KFC (Kentucky Fried Chicken) or McDonalds. It does not necessarily mean that Bhutanese are all vegetarians or meat is unaffordable. The answer is simply logical; it may be the case that no national or foreign business sees immediate profit value in establishing a medium enterprise on 1000-1600 square feet space; to have KFC brand and franchise surely means investment of more than 10 million national currency which of course could take comparatively long time to break even. As per the notification *MOEA/DSCI/01/28* issued by Ministry of Economic Affairs of Bhutan in 2012, the enterprises or industries are classified as: 1). Cottage (which employs 1-4 employees and the

investment value of Nu. Less than a million), 2). Small (employs 5-19 and the investment value of Nu. 1 to 10 million), 3). Medium (employs 20-99 and investment value at Nu. 10-100 million) and 4.) Large (with employment size of 100 or more employees and worth more than Nu. 100 million in investment). As a matter of fact, it can also be noted that the country also does not have world class complex shopping mall. Do these necessarily mean that Bhutan is far from prosperity? In fact, there are enough food to choose from. At least, hunger or poverty is not really an issue in Bhutan although rarely one or two unfortunates may be seen pleading in the urban streets. As of 2019, excluding the edible consumer goods and items dealt by different business enterprises, the Food Corporation of Bhutan Limited (2019) alone had more than 80 food items and 650 options of Fast-Moving Consumer Goods (FMCG) in its list.

In terms of economic policy, the Foreign Direct Investment (FDI) is encouraged and legalised. There were 92 FDI projects in 2020 compared to 83 in 2019 (Ministry of Economic Affairs, 2020). The projects in Hotels, IT/ITES and Manufacturing represented 39%, 21 % and 15% respectively. In 2019, FDI project contributed at least Nu. 1,530.65 million in the form of tax beside creating employment opportunities. The economic prosperity can also be inferred from the increasing market capitalisation value of Bhutanese public corporations and companies. Excluding the private companies and the DHI owned corporations, the Royal Securities Exchange of Bhutan Limited (RSEBL) noted that the total value of its 22 listed public companies alone account more than 50 billion Ngultrum in 2019. This is around 28% of the overall 2019 GDP. The total capitalisation from the listed companies was just Nu. 19.89 billion in 2013. Also, the increasing numbers of traded lot/share is alarming; by 2019 the lot traded is 23,1467,84, a significant increase of 217.5% compared to the shares traded in 2015. The striking rate of change in the value of stocks traded in less than 5 years; the rate of change in trading value stands at whopping 515 % in 2019 from 2015. As of 2020 records, Bhutan had more than 22,000 small and cottage enterprises, 719 medium and 373 large industries. These are the indicators that the economy is growing phenomenally year on.

### 3. Socio-Culture

Socio-culturally, Bhutan is unique from the rest of the world pertaining to how inner values are reflected externally. Although having national flag, anthem or so is normal for every nation state, Bhutanese national dress, for instance, is simply different in itself; no man or women go to office wearing formal suit and tie. Here is the one spot of uniqueness. Every Bhutanese wear ‘gho’ and ‘kira’ for official purposes. Gho and Kira are national dress of Bhutan. Gho is long robe worn by men, hoisted to knee length held tightly around the waist by cloth belt called kera. Kira is long and floor-length dress for women. The bigger picture is that the very way of life is exuded very differently. Although the socio-cultural expressions are slowly being influenced due to the exposure to modernisation and westernisation to be specific, the inevitable modern technology such as television, internet and social media are never discouraged. Bhutan embraced Television and Internet in 1999 signalling the acceptance of 21<sup>st</sup> digital century; first radio broadcasting ‘Radio NYAB (National Youth Association of Bhutan)’ began in 1973, the year when Bhutan’s stamps became the greatest source of revenue and served as little ambassadors or at least cultural attachés (Bil’ak, n.d) ; the first of its newspaper, ‘Kuensel’ was launched in 1986. Socially, people are encouraged to keep the values that bind social harmony through community vitality and cohesion. Above all, ‘Tha-Damtshig (མཐའ་དམ་ཚིག་)’ is the primary socio-cultural value that everyone is expected to practice and live up to. The term ‘Tha Damtshig’ basically refers to personal integrity and moral rectitude which has its origin in Buddhism (Phuntsho, 2016, June 5). Bhutan has come a long way in terms of social development in line with its social values and norms.

Among the social parameters, Health and Education take the primacy as these are being made accessible to the public by the government free of cost; as it was the case in the past envisioned by the monarchs and as per the constitutional requirement every citizen continues and will continue to access these common benefits. *The Constitution of the Kingdom of Bhutan* (2008) states that “the State shall provide free access to basic public health services in both modern and traditional medicines”-Article 9, Clause 21; and “shall provide free education to all children of school going age up to tenth standard and ensure that technical and professional education is made generally available and that higher education is equally accessible

to all on the basis of merit”-Article 9, Clause 16. The improvement in health system because of visionary leadership and long-term policy interventions is clearly visible. Those born prior to or in 1960s were expected to live just a little more than 30 years; by 1977 the life expectancy has increased to 46.1 years which was then further improved to 66.1 years in 1999. According Ministry of Health (2020) “over the span of five decades, the life expectancy has more than doubled to 70.2 years in 2017, from 32.4 years in 1960”. Having achieved so much, Bhutan as of 2020 was still almost two years short of Asian average Life expectancy (73.2 years) and supersede only Africa continent by more than 8 years (United Nations Statistics Division, 2021).

The past decades, especially in 1960s was challenging for the people due to communicable disease such as leprosy and small pox which threatened the existence of certain population while the modern health facilities were yet to be accessible; there were only two trained doctors and four small hospitals in 1960. Today, Bhutan has 3 Referral Hospitals, 48 Hospitals, 184 Primary Health Centres and more than 500 Outreach clinics catering to its less than a million population. Although the number of doctors for 2020 was 0.46 per 1000 population, which is below the World Health Organisation standard of one doctor for every 1000, there were one health worker for every 117 residents (Ministry of Health, 2021). This should be the result of policy priority given for health, and it continues. For the twelfth plan period of 2018-2023, the budget allotted for health sector is more than 9% of the total outlay (Gross National Happiness Commission, 2019).

Education will always be a priority everywhere as it empowers and changes people’s lives. The manifestation of its significance in Bhutan’s 20-year vision document can be accorded for why education has been among the top priorities for the leaders and policy makers. For instance, as per Royal Government of Bhutan (1999), Bhutan should have every adult being able to read and write a short text in Dzongkha, Lotsham, English or any other language by 2017. In actuality the adult literacy was just around 60% compared to 93.1 % youth literacy in 2017 (National Statistics Bureau, 2017a). However, government had been trying its best to increase literacy rate; to this effect Non-formal and Continuing Education was originated to provide functional literacy to those who missed formal education. The 2020 record shows there were 427 Non-Formal Education centres. Due to its impact at grass roots



through literacy, the ‘Non-formal and Continuing Education programme’ of the Department of Adult and Higher Education of Bhutan was awarded 2012 UNESCO Confucius Prizes for Literacy. While Bhutan in 1960s had only 11 primary schools catering to less than 500 students, by 2020 the statistics reveals that there are more than 600 schools, 18 tertiary institutes and 8 vocational institutes including traditional Zorig Chusum institutes; the list is exclusive of other forms of educations such as monastic institutions, continuing education, or non-formal education centres. The general literacy rate in 2020 stands at 71% (Ministry of Education of Bhutan, 2020). In 1968, 20 students were the first to complete high school within the country (Royal Government of Bhutan, 1999) while the tertiary institutions today host more than 12,000 students (Ministry of Education of Bhutan, 2020).

One of the interesting Bhutanese Socio-spiritual-culture is exuded through phallus symbolism. One cannot pretend not seeing phallic symbols either painted on the walls or hanging from the corners of most buildings in Bhutan. The symbol comes in different shapes, colours, sizes, and forms, sometimes even erotically ejaculating. Even during the public festivals of theatrical performances known as Tshechu and Domchoe, which last from one day to several days, audiences would be greeted and entertained by ‘*Atsara*’ with brandishing wooden phallus. A Bhutanese historian and scholar Phuntsho (2016) describes *Atsara* as a sacred-profane character which “combines the spirit of the sacred and profane, wit and wisdom, humour and responsibility”. It may be a culture shock to some foreigners from the west especially who believe sexual manoeuvrings is freedom only within private space, while in Bhutan it is portrayed publicly as part of culture. This is one aspect of symbolic culture in Bhutan. However, socio-culturally prostitution is still considered taboo and legally forbidden; there is an indication though that small scale business transactions seems to be taking place discreetly as one local reporter Pem (18 September 2021) recently published an article claiming that number of sex workers in the capital is increasing [due to the Covid-pandemic]. Underlying this social trend must be the reasons such as urbanisation, modernisation, and unemployment. Only time will tell if public thinking accepts such remnants of socio-cultural shift. Back to the context, the point is, phallus arts symbolise peace, prosperity, spirituality, and fertility. The *Aptsara* act is no less than the representation of non-duality which associate with the

essence of Vajrayana Buddhism. Although Buddhism in Bhutan is spiritual heritage which is supposed to promote principles and values of peace, non-violence, compassion and tolerance, the constitution grants citizens right to freedom of thought, conscience, and religion, of course, without compulsion, coercion, or inducement to belong to another faith.

#### **4. Environment**

Environmental protection is taken seriously in Bhutan. Even the government has least authority over National Environment Commission (NEC) when it comes to environmental protection. The very practical example can be traced in ‘Shingkar-Gorgan’ road manifesto used as socio-economic development agenda by Political Parties. Whether it was Druk Phuensum Tshogpa (DPT), People’s Democratic Party (PDP) or now Druk Nyamrup Tshogpa (DNT) as an elected government, none could fulfill this promise. The DPT and PDP both had this manifesto clearly reflected even in their 2018 Party Manifestos. Although the fulfilment of manifesto means easy reach and access among eastern districts and less risky for travel during winter as a result of not having to cross snowy Phrumsengla pass, it is far from getting the environmental clearance (Norbu, 2019). So, the Royal Bengal tigers always win over the political parties’ plan because, the National Environment Commission is not ready to let the road cuts through protected Phrumsengla National Park. In June 2012, the then government introduced pedestrian Tuesday. Although it drastically reduced movement of vehicles and consumption of fuels, it could not be a sustained owing to other social and economic factors. Similarly, although the success of reinforcement of plastic ban in April 2019 by NEC is debatable, the holistic intention can never be doubted. This is the extent to which Bhutan considers environmental conservation a serious business.

On 19<sup>th</sup> September 2017, Bhutan deposited the Instrument of Ratification to the Paris Agreement to the United Nations Framework Convention on Climate Change. Represented by the then Foreign Minister in the UN Annual Treaty Event held at the UN headquarters in New York, USA, Bhutan became the 161st country to place its Instrument of Ratification (Ministry of Foreign Affairs-Royal Government of Bhutan, 2017). Bhutan’s promise to remain carbon neutral for all time began in 2009



during 15<sup>th</sup> UN Climate Change Conference of the Parties (UN COP 15) in Copenhagen. It still reiterates and stands by the promise. This is a big responsibility requiring compromise and sacrifice. Yangka et al. (2019) in their study through scenario modelling using Long-rang Energy Alternative Planning (LEAP) model found that the carbon declaration will go off track between 2037 and 2050, if measures are not taken. This is bad news for economy as it is predicted to cost two percent of the GDP. This clearly means Bhutan should choose efficient technologies while also focusing on electrifying transportation and industry. Initiatives are already being taken. For instance, government encourages the use of electric car through the lowering of taxes. The public transportation is even encouraged in the form of central bank allowing ceiling of 50% loan for purchase of electric vehicles, and 20% subsidy grant for electric taxi. It was expected that by 2022 more than 300 taxis would be electric powered under the 'Low emission urban transport systems' project (Gyem, 2019, May 9). But as of 2021, only 16 Electric taxis are on the road, and of course the reason being due to the Covid-19 pandemic disruption according to the relevant official. The basic infrastructure needs to be improved. As part of the project between Royal Government of Bhutan and UNDP and Global Environment Facility, 13 DC (Direct Current) and 11 AC (Alternating Current) chargers for electric cars were installed in Paro, Haa, Thimphu, Punakha and Wangdue in June 2021 (Ministry of Information and Communications-Royal Government of Bhutan, 24 June 2021).

Taking the current environment stock into account, Bhutan's forested area stands at 72.2 %, more than double the world's 30.8% of the total forest. Even in terms of important sites protected for terrestrial biodiversity, Bhutan still maintains at 47.3% against 43.7% of the world. These are among the nine environment and infrastructure indicators accessible in United Nations data bank. As per the National Biodiversity Centre (2019) Bhutan hosts 11,248 species categorized under the five kingdoms of Animalia, Plantae, Chromista, Eubacteria, Fungi, and Protista. This is 0.8% of the total biodiversity in the world; and discovery of new species continues. Gyeltshen et al. (2020) who works and researches for National Biodiversity Centre of Bhutan discovered at least 33 species new to science and recorded 566 species of flora and fauna new specific to Bhutan between 2009 and 2017. It is conclusive that Bhutan is rich in biodiversity which needs to be protected.

## **Review of Relevant Literatures**

### **1. Leadership-History and concept**

Leadership is a pervasive and phenomenal subject. In fact the examination and evaluation of leaders and leadership advances with the rise of civilization and the very accounts of leaders in the form of kings, prophets, priests and chiefs have solidified as symbols, representatives, examples and role model to be followed (Bass & Bass, 2009). The leadership as a concept is not new; Roggio (2011) notes that the topics of leaders and leaderships comprised the important themes such as in the ancient Greek and Latin Classics, Old Testament of the bible, the Hindu religious scripts, and in the principles of Confucianism. Bass, & Stogdill (1990) state that leadership is one of the world's oldest preoccupations and interestingly sums up that the study of leadership is as old as the age of emergence of civilisations. They also note that written philosophical principles on leadership emerged as early as Egyptian hieroglyphics for leadership, leader, and the follower which were written more than 5000 years ago. Number of academic research and systematic inquiries have been conducted gradually on leadership as applied social theories and system. The interest on the subject is shaped by the belief that certain exceptional individual capacities are able to set up broad orientations, promulgate new norms, articulate new goals, establish organisational frameworks, and arrange resources necessary for all these purposes and actions that are fundamental to institution building in social systems (Nohria, & Khurana, 2010). Understanding Leadership sometimes tend to become very complex. Antonakis et al. (2012) suggest that the common agreement can be drawn based on: (a) an influencing process and its resultant outcomes that occurs between a leader and followers and (b) how this influencing process is explained by the leader's dispositional characteristics and behaviours, follower perceptions and leader attributions, and the context in which the influencing process occurs.

One ancient philosopher and scholar by the name Plato (who lived 428/427-348/347) had identified three types of leadership based on the rule of reason, the rule of desire and the rule of spirit (Ronald, 2014). On the contrary, Machiavelli (2011) propagated that a leader should be rather feared than loved by their followers. That's why words such as 'necessity, must, have to, inevitable, success, victory,

prestige, achievement, loss, failure, defeat, death' are recurrent in his expressed thoughts and ideas. After all, Machiavelli's thought was positioned and situated to suit political leadership, with less regards on ethical components as long as the Machiavellian methods guarantee victory and success. Ronald (2014) noted that Machiavelli deviates from ancient Greek scholasticism, medieval religious doctrines and also with the utopian ideals of his contemporary religious figure when Machiavelli encourages his ideas on realism and calls for a prince (leader) through radical means to accomplish personal ambition of glory and honour, even if it involves immoral actions and behaviour. According to Bass and Bass (2009), concepts and definitions of leadership have been evolving and expanding; in the first several decades of the twentieth century, leadership was considered a matter of impressing the will of the leader and inducing obedience, while in the current age of information, leadership is seen as more of consulting and shared decision making. This indicates that the definition and the concept of leadership is evolving, dynamic, contextual, and situational. In essence, leadership is multi-faceted which can be interpreted differently considering the situation, time, and context.

## **2. Scholarly investigation of Leadership theories and application**

Leadership continues to be worthy of serious intellectual inquiry. Day and Antonakis (2012) have observed that the leadership is one of the most examined subject areas in the social sciences and acknowledged leadership as crucial for effective functioning of organization and society. Among the notable contemporary leadership expert is Joseph C. Rost, whose contribution to the Leadership Literature is very respectable. In his seminal work on Leadership, Rost (1991) studied the patterns of scholarly discussion since 1900 based on around 600 sources. It can be noted that the leadership between 1900 and 1929 emphasised on 'control and centralisation of power'. By 1930s, the leadership theme gradually shifted from 'domination' to 'traits' of a leader and continued in the 1940s. At the same time, the 1940s belong to those who promoted the group approach to leadership; and within these decades two most significant incidences happened-The World Wars. Although the group approach lost some advocates in the 1950s to the behaviourists led by Halpin (1957) and his Ohio State colleagues, it continued to flourish in leadership studies for many years. Leadership definitions of the 1960s show increasing support for viewing leadership as

behaviour process that influences people toward shared goals. A surprisingly large number of definitions are noted to reflect this theme.

Warrick (1981) noted that most of the organisational leadership experts agree that the traits, leadership styles and contingency are the major leadership theories. While the discussion and understanding leadership traits still happens to be important, the very fundamental fact that 'leaders are born' is simply biased and flawed. In this line, Warrick (1981) believe that the dismissal of traits theory is due to the theoretical, methodological, and practical problems. Hence, while the 'traits' per se cannot be ignored, the philosophical grounding on which traits theory was developed is rejected. While the Leadership as the subject of the inquiry is taken seriously, the pattern of focus shifts from 'what qualities leader possess' to 'what leaders do'. Of course, the traits theory would have been immensely well received when the physical characteristics were necessary component to define leadership. For instance, history speaks that great military and political figures had certain traits qualified to be categorised based on 'Great man theory'. The time, context and situations were different. The current sentiment and interpretation on leadership is a complete shift; the term 'great man' itself can be perceived to be derogatory especially when the contemporary discussions are picking momentum on inclusive leadership, learned leadership, women empowerment, and leadership.

An organisation's existence is determined by the 21<sup>st</sup> Century conditions, where physical traits are not primary characteristics of a leader but the ability to manage knowledge workforce. Hiebert and Klatt (2001) compares the late twentieth century and the early twenty first century leadership in terms of organisational culture, people, systems, information, and leadership style, and even job design. The demand of the leadership transcends century to century. For instance, the bureaucratic systems with top-down leadership which seemed to have worked in the past organisations cannot be applied in same length and breadth today. The research supported theories and framework of leadership, especially relatable to business organisations include Leadership Types Theory (based on studies conducted by Ohio State University and Michigan University in 1945 and 1950s respectively), Contingency Model of Fiedler (1964), Situational Leadership Theory of Hersey, & Blanchard (1997), Path-Goal Theory of House, & Mitchell (1975), the Blake, &

Mouton (1964) Leadership Grid, and Lewin's Leadership Styles framework by Lewin et al. (1939). The behaviour theory based on research of Ohio State University and Michigan University identifies the level of leader's concern for people and task while Contingency and Situational theories put the proposition that no single leadership style is best but conditional. Path-Goal theory suggest that leaders should be able to match the motivation and satisfaction of employees so that the goal is achieved. The leadership grid frameworks classify leadership into different quadrants based on certain behaviour and characteristics.

### **3. Corporation and the existing Leadership Concepts**

The concept of leadership in business seems relatively new. It was observed by Walter Friedman, one of the well-known academic figures on the subject of leadership that the term 'business leadership' started appearing in U.S. newspapers only occasionally during Carnegie's heyday, and popular books on leadership started to be seen from 1912 onwards (Gill, 2011). However, today, every business and management programmes have leadership as essential subject of study. In his introductory remark of the book, Drucker (1993) would claim that the concept of the corporation led to the establishment of management as a discipline and as a field of study, and most importantly, established organisation as distinct entity. He also stated that until then, the traditional sociology only knew about society and community. The corporation as a business system was a little known, even for the economists in the past, as Mueller (2020) states that what was began to be known as corporation or joint stock companies at the end of 18<sup>th</sup> century were relatively rare even when Adam Smith (1723-1790) wrote very influential book on economics, *The Wealth of Nations*. Regarding this deductive analysis, it can be argued that Karl Marx (1818-1883) would not have hold extreme opposing view against the system of capitalism, if and only if it was known to him that everyone including working class (proletariat) would be eligible to buy stocks and own part of company. However, Truitt (2006) points out that the concept of corporation started in medieval times as the Aberdeen Harbour Board in Scotland dated from 1136, the century in which the Catholic Church accepted the legitimacy of private property, very prerequisite for a corporate ownership. In fact, this seems very true. This can be verified through current Aberdeen Harbour website which mentions that it was established in 1136 by King



David I of Scotland and takes pride in the fact that it is 'oldest existing business in Britain' marking unique history in the Guinness Book of the Business Records.

So, for more clarity, let's discuss what is a company or corporation. Well, what is Corporation then? Stock company or a corporation is defined as a "profit-seeking enterprise of persons and assets organized by rules" (Eisenberg, 1989); Williamson (1981) adds that there is the common agreement to the proposition that the modern corporation is a 'complex and important economic institution'. The discourse on corporation, however, focuses on whether corporation is entity separate from its shareholders, artificial creation of state laws or natural outcome of private initiative, and whether it is public or private entity (Millon, 1990). According to Truitt (2006) four types of corporate forms have emerged over the years, and asserts that all corporations are artificial beings, treated as 'persons' before the courts although their existence is neither tangible nor visible. The activities of corporation in general include purchasing raw materials, manufacturing, marketing and selling goods and property, entering into contracts, borrowing capital, suing and being sued, recruiting and even dismissing employees or so (Truitt, 2006). The companies in Bhutan which are classified as 'Public company' is authorised by its Articles (of incorporation) to offer its shares or other securities to the public; 'Private company', not permitted to offer its shares to the public; and 'Government company' shall be incorporated as public company, and can be created through the effect of Act of Parliament (the Companies Act of Bhutan, 2016). Thus, with the concept of incorporation of companies arise the focus on "organisational leadership" and "corporate governance".

For several years, the leadership focus was derived from a concern in organisational psychology to understand the impact of leader style on group behaviour and outcomes with two interest dimensions: 'task focus' versus 'people orientation' (Storey, 2016). This contribution is fundamental for the current leadership studies. Glynn and DeJordy (2010) also note that in the past 50 years, organisational scholarship on leadership has shifted from an emphasis on the leadership significance for meaning making to the importance of leadership for business and economic performance. This clearly indicates the shift in the theoretical foundation to impact that leadership create for the organisation. This is especially true to certain extent that organisation needs to survive in today's globalized and competitive platform.



Leaderships are defined in terms of leadership persona, process and conduct, performance and effects, individual-micro and whole-macro levels (Glynn & DeJordy, 2010). Going by the research and studies on Leadership in business organisations, leaders are interpreted through different types such as Transformational leadership, Self-Leadership, Servant Leadership, Ethical Leadership, Sustainable Leadership, and Value based Leadership. The transformational Leadership has caught the attention of the academics and researchers for the last two decades at least. Transformational leadership according to Northouse (2021):

...is a process that changes and transforms people. It is concerned with emotions, values, ethics, standards, and long-term goals. It includes assessing followers' motives, satisfying their needs, and treating them as full human beings. Transformational leadership involves an exceptional form of influence that moves followers to accomplish more than what is usually expected of them. It is a process that often incorporates charismatic and visionary leadership.

Bass et al. (1987), Bass, & Avolio (1994) and Avolio, & Bass (1995) identified determinants of transformational leadership as 'Four I's': idealized influence, inspirational motivation, intellectual stimulation, and individualized consideration. Also, it is very clear that articulating a vision, fostering the acceptance of group goals, modelling behaviours consistent with the vision, providing individualized support and consideration, setting high performance expectations, and providing intellectual stimulation are the dimensions of the transformational Leadership (Podsakoff et al., 1996; Podsakoff et al., 1990). The transformational Leadership construct are usually measured through Podsakoff and colleagues' 22-item multidimensional measure (1996) with a 7-point response (1 = *strongly disagree*, 7 = *strongly agree*) or Global Transformational Leadership scale developed by (Carless et al., 2000).

The Ethical Leadership is yet another important leadership topic of the study. Brown, & Treviño (2006) have observed that philosophers have approached ethical leadership from normative perspective which is more of about what ought to

be and the 'being'. Northouse (2019) also states that, pertaining to leadership, ethics and character define who leaders are and their behaviour determine what leaders do. Leadership then is simply the consequence of leaders' behaviour, and their virtuousness. In effect, ethical leadership covers moral and ethical decision making, and conduct. According to O'Keefe et al. (2019) ethical leadership encompasses the personal conduct of leaders and leaders' expectations that followers behave ethically, and higher levels of perceived ethical leadership lead to greater organizational identification, which then predicts organizational outcomes. The ethical leaders were found to place more emphasis on being credible moral role model. However, when culture and customs are factored in, the projection of an ethical behaviour may vary as Sudsakorn and Rattanawiboonsoom (2018) observed that ethical behaviours bear variation of perspectives than unethical behaviours; what is considered 'normatively appropriate' in one organisation may not be necessarily regarded same in other. In general, the instrument developed by brown et al. Brown et al. (2005) is used for ethical leadership researches. Various studies were also conducted over the past decades on servant leadership within the organisational setting. The concept of a servant leadership is more of qualitative and complex derivation. However, many scholars try to come up with a concrete empirical construct. Focht and Ponton (2015) came up with at least 12 characteristics which are supposed to define servant leadership. These common characteristics were narrowed down based on the Delphi method of enquiry. The identified characteristics are valuing people, humility, listening, trust, caring, integrity, service, empowering, serving others' needs before their own, collaboration, unconditional love, and learning. The leadership of the self has also been increasing its importance.

Stashevsky et al. (2006) aligns the concept of Manz (1992) self-leadership to an influence-related process through which each individuals and working groups direct, inspire and lead themselves towards fulfilling desired behaviours and outcomes. Initially, self-leadership was understood as a comprehensive self-influence perspective leading oneself toward performance of intrinsically motivating tasks as well as managing oneself to do work that must be done but is not naturally motivating (Manz, 1983). There are still varied interpretations of self-leadership and is understood and defined differently by different scholars. However, the common

instrument used for the measurement of the self-leadership is a Revised Self Leadership Questionnaire (RSLQ). In fact, the leadership of self is the corner stone for any kind of leadership. His Majesty the Fifth King of Bhutan, Jigme Khesar Namgyal Wangchuk addressing the 146<sup>th</sup> convocation of the Calcutta University held in 2010 expressed that:

...in this global village– on a daily basis we are not fighting world wars or military conquest– every single day we are fighting the consequences of simple human negligence, complacency, lack of compassion, inequality. What we need is not a Leader to lead the Masses- we need Leadership of the Self. This is my message today. I do not know how to find the cure for diseases and I cannot tell governments or multinationals to respect the environment- but I can assure you with all confidence that each of us can be better individuals– better human beings. Whether we become farmers, scientists, inventors or bureaucrats, the one thing we can all do alike is to live our lives according to the values of kindness, integrity, justice– we can be good human beings

(Bhutan Broadcasting Service, 2010, October 7)

This powerful statement should be very much interpreted, contextualised and exuded by every Bhutanese, not just officially positioned and authorised Leaders alone. Here is the immense recognition of the leadership of the self as more valuable than the assigned “positional leadership”, from the supreme leadership of the nation which value Gross National Happiness. Indeed, this is a food for thought for all.

#### **4. The Concept of Gross National Happiness**

Generally, the policy decisions are made considering level of GDP in most cases. Boltvinik (1999) notes that poverty is primarily measured in monetary terms with less focus given on social indicators which result in social schizophrenia. This translate that the GDP, the aggregate of goods and services measurable with money is the yardstick how development is measured today in the world. From the similar angle, Lepeley (2017) mentions that Gross Domestic Product (GDP) has been the standard metrics of economic growth and progress for half a century. This is

despite the increasing recognition that GDP measures everything except deeper and meaningful aspects of life while GDP still continues to measure poverty, implement policy and operationalize practice in narrow economic and technical terms, with less attention given to the holistic and interconnectedness of development as lived and experienced (Verma, 2019). This has its roots in the economist interpretation where utility maximisation of material consumption and rational decisions define happiness in microeconomics context (Ribeiro, & Marinho, 2017).

This can be confirmed based on how countries are classified their development status at in terms of economics standard. United Nations Department of Economics and Social Affairs (2012) categorises countries as developed economies, economies in transition and developing economies based on economic condition criteria comprised of GNI per capita, a human assets index and an economic vulnerability index. Similarly, according to the World Bank (2021) low-income economies are defined as those with a GNI per capita, calculated using the World Bank Atlas method, of \$1,035 or less as of 2019; lower middle-income economies as those with a GNI per capita between \$1,036 and \$4,045; upper middle-income economies are those with a GNI per capita between \$4,046 and \$12,535; high-income economies are countries with a GNI per capita of \$12,536 or more. These classifications are totally in terms of economic values of countries.

Technically, these classifications are not faulty per se. But, in such a case of reference, even a country spending billion in the production of war equipment and its industries engaging in the production of goods and services, not necessarily beneficial for the society, and at the cost of the environment and rising inequality within the society can generate fat economic scores. However, the term “development” should be more than just economic threshold and therefore measuring development through GDP or GNI alone is limited; the increase in GDP is not proportional to rise in subjective well-being, does not value free time and leisure, social and economic services of households or families (Ura, 2005). According to Commission of European Communities (1993) “GDP is the sum of gross value added of all resident producer units plus that part (possibly the total) of taxes on products, less subsidies on products, that is not included in the valuation of output” while they define GNI as “equal to GDP less primary incomes payable to non-resident

units plus primary incomes receivable from non-resident units. In other words, GNI is equal to GDP less taxes (less subsidies) on production and imports, compensation of employees and property income payable to the rest of the world plus the corresponding items receivable from the rest of the world”.

Of course, by 1990 the United Nations (UN) began recognising the development next level by considering human beings as ‘primary end’ and ‘principle means’ (Anand & Sen, 2000). The United Nations Development Programme (2020) has published the Human Development Report 2020 where Human Development Index (HDI) was based on the components of life expectancy at birth (measured in years), Education-years in schooling, and GNI per capita (Purchasing Power Parity). The Human Development Report is annual publication of the United Nations. Even the consideration of poverty measurement from unidimensional to multidimensional method is a paradigm shift of perspective. Today the United Nations (UN) uses multidimensional method developed by Alkire and Foster (2011a) to measure the poverty. In September 2000, Leaders of 189 countries committed to achieve eight millennium development goals by 2015, with signings of the historic Millennium Declaration in UN headquarter. Now the focus of United Nation (UN) is on building a sustainable world where environmental sustainability, social inclusion, and economic development are equally valued with adoption of ‘The 2030 Agenda for Sustainable Development’, by the United Nations Member States in 2015. These are indications of rethinking development and is a welcome initiative by the world leaders; after all this must be a natural process of hedonic adaptation. Material and economic indicators can be factors of happiness only up to certain level. Robertson and Cooper (2010) provide interesting example of yacht experience. They state that sitting on a yacht in the Mediterranean with luxury of unlimited sun, food and drink can make most people thrilled and happy but only for a while; gradually, it would surely begin to seem pointless and would challenge the happiness of even the most determined hedonist.

For Bhutan, Gross National Happiness is the cornerstone to every public policy. When the whole world calculates development based on Gross Domestic Product (GDP), Bhutan introduced “Gross National Happiness” as a measure of development. It aims to achieve a balanced development in all the aspects of life



that are essential for our happiness. The GNH Centre (n.d) defines Gross National Happiness (GNH) as “a holistic and sustainable approach to development, which balances material and non-material values with the conviction that humans want to search for happiness”. This all-inclusive view of development was promulgated by His Majesty Jigme Singye Wangchuck, the fourth King of Bhutan. It is recorded that on the way from Non-Aligned Movement (NAM) meeting in Havana in 1979, His Majesty was asked by a journalist in present Mumbai, what is [was] Bhutan’s GNP on which the Majesty was said to have replied that, for Bhutan, “*Gross National Happiness is more important than Gross National Product*”, thus giving birth to the term, “*Gross National Happiness*” (The Permanent Mission of the Kingdom of Bhutan to the United Nations in New York). According to one of the documents of the Centre for Bhutan & GNH Studies, the international attention on Concept of Gross National Happiness soared in 1980s. The document identifies at least three published articles in *Los Angeles Times* and *New York Times* in 1980, a book by international writer in 1985, an article in *Financial Times* in 1987, a tribute article in *Kuensel*, national newspaper in 1988, and an article in *Miami Herald* in 1989.

It can be clarified that, while there are certain sources that GDP is compared to explain GNH, almost all these sources identified by the Centre for Bhutan & GNH Studies indicate that Gross National Product (GNP) is usually referred as juxtaposition for Gross National Happiness. For example, *The New York Times* in 1980 quoted the Fourth King of Bhutan as expressing “there is a gross national product but there is also gross national happiness”. In any case, it can be concluded that GNH is about holistic development in addition to quantitative economic criterion. It is the middle path approach to balance material and non-material values as a means for fulfilling human needs for happiness. To make it clear GNH does not oppose material and economic progress as is reflected through the statement that “the State shall endeavour to achieve economic self-reliance and promote open and progressive economy” (*The Constitution of the Kingdom of Bhutan*, 2008). In fact, the home-based term is ‘*Gyalyong Ga-Kid-Pelzom*’ where **Ga-Kid-Pelzom** is understood as the aggregate fulfilment of Happiness (Ga) Peace (Kid) and Prosperity (Pel) nationally (Gyalyong). The goal of ‘peace, prosperity and happiness’ is the very hallmark of His Majesty’s Leadership; towards the end of the coronation



speech in 1974, His Majesty the Fourth King articulated hope for the nation that “...our glorious kingdom of Bhutan will grow from strength to strength and certainly achieve prosperity, peace and happiness”. One may draw parallelism of Prosperity and GDP as GNH also considers living standard measured through economic indicators; the GNH approach takes a deviation only from the common belief that national success is measured by the sole unidimensional criterion of Gross Domestic Product (GDP) paradigm. GNH is based on the foundational belief that development should be holistic and multidimensional.

### **5. GNH in Business and Operational definition of Leadership**

The former and the first democratically elected Prime Minister, Dasho Jigmi Y Thinley expressed that all business including tourism must ultimately align well with National Development policy of Gross National Happiness. His Excellency played a pivotal role in taking the concept to the wider global forum through academic pathways in the forms such as Keynote address in international conferences and lecturing in renowned academic institutions in addition to international policy making bodies. During his tenure (2008-2013) as Prime Minister, ‘Happiness’ based on GNH was taken up as an agenda to UN General Assembly (UNGA) in 2011 and on 28 June 2012 the UNGA in its 118<sup>th</sup> plenary meeting declared 20 March as ‘International Day of Happiness’ through the resolution A/RES/66/281. This is in recognition of relevance of happiness and well-being as universal goals and the importance of their recognition in public policy objectives for a more inclusive, equitable and balanced approach to economic growth that promotes sustainable development, poverty eradication, happiness, and the well-being of all peoples. In April 2012, a high-level conference was held by Bhutan based on the request of Mr. Banki Moon, the then Secretary General of UNGA where more than 800 participants from all walks of life, business leaders, NGO representatives, ambassadors, government economic experts including six noble laurels attended the conference. Sachs (2011) who under the guidance of Bhutanese Prime Minister co-hosted the conference as a preparation of the agenda expressed that all who gathered in Thimphu, Bhutan, prior to declaration by UN General Assembly (UNGA) agreed on the importance of pursuing happiness rather than pursuing national income. He added that the participants examined how happiness could be achieved in a world that is

characterized by rapid urbanization, fast influencing mass media, global capitalism, and environmental degradation.

Dasho Tshering Tobgay, the succeeding Prime Minister of Bhutan (2013-2018) initiated to infuse GNH into businesses for sustainable development. This was an antidote to traditional model of business involved in Profitability and the GDP. The operationalization and application of this concept is especially intended for business organisations. Left unchecked, and if business is driven purely by profit motivation, it leads to undermining the society in which business operates. In his Keynote address during the Proceedings of the Seventh International Conference on Gross National Happiness, His Excellency the Prime Minister exerted that the integration of GNH in business would essentially mean that businesses orient towards behaving ethically and responsibly valuing societal well-being over profit. His excellency added that from GNH perspective, business is a critical player in the society, and must make at least equal contribution or more, to improve public happiness and well-being. This can only be achieved when business integrate GNH values not only for addressing social and environmental concerns but also for making itself sustainable and profitable (Centre for Bhutan Studies & GNH, 2018; GNH, November 2017). Zangmo et al. (2017) states that going by the Current practices, business establishments rely only on financial indicators to measure its performance while financial report fails to capture its impact on environment and communities. They argued that delivering returns to those who have provided the capital is only one of the many roles a business should be concerned about.

Hence, the concept of Gross National Happiness should be seriously considered, and the extent to which GNH Values are applied practically in the businesses will be determined by the organisational leadership. The leadership in the organisation has important stake. Leadership in Corporate organisations are expected to provide both creativity and insight in its approach to performing business with values. The good news about leadership is that it can be taught and learned to realise the set objectives of the organisation. However, a focus on key issues and critical themes highlight the importance of the context within which any interpretation of leadership takes place and within which efforts for leadership development must be designed and evaluated (Storey, 2004). For this study, 'Behaviour, Skills, Awareness,

and Character' are especially chosen as the dimensions of the business organisational Leadership. In fact, these dimensions are considered to integrate and synthesise various leadership theories to form and define contextualised business leadership framework. The theories are filtered based on the criteria of established and validated theory, relevancy, universality, and applicability. The 'Leadership behaviour', first dimension of Leadership is based on the leadership types identified through the study conducted by Ohio State University and Michigan University. Both studies consider the level of leader's orientation for 'People' and 'Task'. The former classifies leaders' focus as 'Consideration' and 'Initiating Structure', where 'consideration' is defined as behaviours by means of which the leader establishes rapport with his or her employees, two-way communication, mutual respect, and understanding. The 'Initiating structure' is defined as behaviours by means of which the leader defines or facilitates group interaction toward goal attainment. Fundamentally, this theory is the basis of contemporary leadership studies. This is especially significant and relevant to the business setting where two main objectives of employee well-being and organisation goal is seen as a continuum in the same spectrum. Also, the 'Action Centered Leadership' by Adair (2011) corresponds well with this. The three important needs of task, team and individual are the necessary requirements of the leadership which need constant consideration. This dimension of leadership will be able to first identify whether the organisational leadership is people centered or task centered, and then further appropriately classify based on Integrating Leadership Style approach. This can approximate the organisational expectation and reality of leadership.

Warrick (1981) categorises leadership styles into four quadrants: 'Human Relations, Democratic, Autocratic, Laissez Faire', which is very much similar to the Situational Leadership theory framework of Hersey et al. (1979) which identifies leadership into: 'Participating style, Selling style, Delegating style, and Telling style'; Blanchard et al. (1993) later relabelled in the revised model as Directing, Coaching and Supporting for Telling, Selling, and Participating respectively. Hence, the four styles are Directing, Coaching, Supporting and Delegating. This Leadership behaviour also aligns well with Lewin's leadership style framework consisting of 'Participative leadership, Authoritarian Leadership, and Delegative Leadership'. Similar to leadership model of Ohio State University and Michigan University and the other

Leadership styles model is the Managerial (later renamed as Leadership) Grid developed by Blake et al. (1962) and later refined by Blake and Mouton (1964). Based on the intersection of two variables a) organizational needs for production and profit and (b) human needs for mature and healthy relationships on a set of coordinates, and using values of 1-9, the 5 styles of leadership are identified as: country club management (1, 9), impoverished management (1, 1), middle-of-the-road management or Organisation management (5, 5), team management (9, 9), and task management or later renames as authority-obedience-management (9, 1).

Another aspect of the leadership considered for this research is 'Leadership Skills'. According to Peterson and Van Fleet (2004) skill is simply the ability to accomplish some specific behavioural task or to perform some specific cognitive process that is functionally related to some particular task which comprises: the existence of a domain specific knowledge base; a method for accessing this knowledge base; and the ability to enact a set of behaviours or cognitions using the retrieved knowledge to perform the given task. Punia et al. (2004) also states that skill is all about translating the learnt ability and knowledge into performance and complete the specific task successfully while Katz (2009) in his own statement implied skills as an ability which can be developed and manifested but not necessarily inborn and mere potential. This is interesting interpretation of skills; after all, if skill is already a permanent state, nothing good comes out of studying the leadership skills. In his three-skill approach of an effective administrator, Katz (1974) identified the three important developable skills: 'Technical Skill, Human Skill and Conceptual Skill'. While the first skills relate to the understanding, and proficiency in specific activity involving methods, processes, procedures, and techniques, the second skill is all about the ability to influence, inspire, lead, and work in group. The conceptual skill is holistic where the leader can see the enterprise as a whole and be able to understand the relational aspect of the players within organisation and the outside stakeholders. This corresponds well with the transformational Leadership. According to Gooty et al. (2009) transformational leader articulates vision yet provide individualised support and consideration. Similarly, Mumford et al. (2000) have developed capability model to explain leadership and leader performance. They believe that leadership can be well comprehended in terms of knowledge, problem-solving skills, solution



constructions skills, and social judgement required to solve the problems in organisations.

However, Katz's model of leadership is more relevant to be considered as leadership domain in the present context owing to its simplicity and relevancy. The other model is more complicated and was developed to specifically relate with leadership for solving organisational problem. The Katz model has wider influence in the academic world as well, as evident from the statement "Katz's articles has had a solid impact on the management field" (Peterson, & Van Fleet, 2004). In fact, this is very true. As of April 2021, the Google scholar database shows reprint of Katz (2009) (*Skills of an effective Administrator*) has been cited 2351 times out of which 269 cited articles are in Web of Science Journals alone. The Katz model is being widely discussed in business school classrooms as well. Almost all the Organisational Behaviour syllabus have these skills included for dissemination and discussion in relation to what skills are required by the managers and leaders.

The third dimension of the proposed leadership variable is 'Awareness of Leader' which shall cover the ability to comprehend the external environment and developing situations around. It can also be understood in terms of situation awareness; O'Brien et al. (2020) states that situation awareness is understanding 'what is going on' and it can be viewed from individual, team or system perspective. It is thus defined that individual view of situation awareness as the perception of elements, comprehension of their meaning, and projection of future status. Endsley (1988) in the Aircrew decision model for maintain high pilot situation awareness under Situation Awareness Global Assessment Technique (SAGAT) specifies '*Situation Awareness*' as composition of 'perception of elements in current situation', 'comprehension of current situation' and 'projection of future status'. While the Situation Awareness (SA) seems to have evolved from military strategies, this is appropriate for all organisations. The leadership's Situation Awareness can also include the leaders' comprehension of the 21<sup>st</sup> century organisations, their knowledge workforce, and the future directions. This domain relates with the general knowledge and the disposition of leaders to adapt to the dynamic situations with proactivity. The situation awareness thus is about gathering information, recognising, and understanding the situation and anticipating what will be the next. At this point, some may perceive duplication of this

with the skills aspect, particularly with the Conceptual Skills of a leader. To clarify, this leadership dimension will measure the awareness of leader in terms of the environmental, legal, and technological developments around the organisation while the conceptual skills should relate more with the internal systems in line with organisational vision, mission, and objectives. Hence, awareness of a leader pertaining to technological advancement, socio-economic situations, public policy, and Legal issues are focussed. This is associated with the leadership ability to assess '*external risk*' for the organisation.

The fourth and final measure of Bhutanese corporate leadership is 'Leader Character'. It is imperative to explain that the concept of GNH is intertwined with the Buddhist values of way of life and scientific approach to understanding mind. They relate very well. By this logic, Bhutanese leadership should seek for creating lasting happiness through reduction of suffering, and balancing self and society, and creating harmonious society based on equanimity, loving kindness, and shared reciprocal joy (Kriger & Dhiman, 2018). On this basis of goals, set of values, 'principles or standard of behaviour' have been identified: impartiality, loving kindness, compassion, and sympathetic joy. Also, generosity, discipline, patience, diligence, and concentration should be the expected hallmark of Bhutanese Leadership character and ethics. These in strict spiritual sense are termed under '*boundless qualities*' and '*bodhicitta precepts*' as explained by Patrul Rinpoche (1998). It is inevitable this dimension entails holistic concept manifesting through body-mind-speech of a leader (Ku-Sung-Thug or Lui-Ngag-Yid). This imply that leadership carries pure intention, right expression, and action with values in the form of ethical commitment, authenticity, integrity, and self-belief. This is leadership at moral and ethical construct level defining the very character. Hence, leader's personal values of authenticity, integrity, commitment, and self-belief shall form the factors of leader(ship) Character. However, this is not to claim that these values are exclusively relevant for certain section; its oriental yet universal. For example, Koehn (2005) who studied 'integrity as a business asset' concluded that although contrasting at philosophical level, both Buddhism and Christianity agree from same perspective on points central to acting with integrity. Such fundamental values hold true with other belief systems as well. The other reference point for the leadership ethic can be derived from the visionary



speeches, model behaviour and enlightened intention of His Majesty the Kings of Bhutan. The National Day speeches of His Majesty indicating the expected ethical and moral standards of the leadership from country's leaders will be the basis of the construct of the leadership ethics for this study. Also, the corporate values of the DHI companies will be considered. Thus, it is expected that Bhutanese organisational Leaders score high and qualify all these four domains.

For this study, the Leadership is, thus, designed as '*a multi-dimensional model*' which comprises dimensions of 'Leadership Behaviour', 'Leadership Skills' 'Leadership Awareness' and 'Leadership Character'. The ideal Leader is expected to have scored 'High' on all the four dimensions. Thus, these form the concept of 'leadership' for this study. Hence, an operational definition of organisational leadership for this study is taken as a process of interaction with their subordinates resulting in achievement of organisational goals through the influence of leaders' fitting behaviour, required skills, moral ethical characteristics, and holistic awareness. The components of organisational Leadership framework are represented as follows:

**Table 2 Leadership Dimensions**

Behaviour	Skills	Awareness	Character
<ul style="list-style-type: none"> <li>• People Oriented</li> <li>• Task Oriented</li> </ul>	<ul style="list-style-type: none"> <li>• Human Skills</li> <li>• Conceptual Skills</li> <li>• Technical Skills</li> </ul>	<ul style="list-style-type: none"> <li>• Technological advancement</li> <li>• Socio-eco-politico situations</li> <li>• Policy and Legal issues</li> </ul>	<ul style="list-style-type: none"> <li>• Ethical commitment</li> <li>• Authentic Influence</li> <li>• Self-belief</li> </ul>

So, how should Gross National Happiness (GNH) in Corporation interpreted, understood, and measured? It is important to understand the context first. As mentioned earlier, in the initial stage 'GNH of Business' was used as an idea to initiate and align business towards GNH. In deed it was an attempt to take national development policy into business by formalising and implementing through the business organisational eco system. Zangmo et al. (2017) in the Proposed GNH in Business framework, expressed that:

...The financial report fails to illustrate the degree to which business impact the health of environment and communities. For example, a business, which often pollutes and destroys habitats, is seen to rank at the top due the mere presentation of financial statements with higher returns. Hence, a shift toward GNH would require businesses to incorporate non-economic indicators encompassing aspects such as job satisfaction, contribution to the community, and environment. If business entity includes GNH as one of its primary goals and integrate GNH-based indicators, it can contribute to creating a vibrant and sustainable socio-economic condition.

As directed and tasked by the government, the Centre for Bhutan Studies & GNH have pilot tested and drafted a report 'Proposed GNH in Business' which was presented to the experts during the Seventh International Conference on Gross National Happiness held in 2017. After having incorporated expert suggestions, recommendations from the further consultation meetings held with stakeholders, and another round of pilot study, the 'GNH Certification' framework was published as a guideline. Whether this certification process and accreditation is well received by business entities is yet to be tested.

Let's begin with the question. Does GNH integrated business or corporation indicate '*socialistic*' economy, left aligned in the ideological spectrum? There are instances that the GNH infused business corporation could be misinterpreted and misunderstood. At one-point in time, one of the local newspapers published series of interviews titled 'Dr. David's Critique of Bhutan's GNH stories'. Dr David L Luechauer, a foreigner and an academic who was then working in one of the colleges in Bhutan was quoted as:

...I just gave a leadership presentation to 50 Chief Financial Officers of major companies [in the US]. I was introduced as just having returned from Bhutan. You have to understand, these were men & women, who held the senior financial position in companies worth anywhere from 100 – 500 million dollars... In terms of GNH, the typical response was oh yes, aren't they the people trying to be happy or something like that. The even fewer

who had any substantive knowledge of GNH basically had the same impression – it is nothing more than environmentally friendly socialism. In my experience teaching and lecturing around the world – Business leaders, the people who really create jobs and drive economies, neither knows nor particularly cares about either GNH or Bhutan

(The Bhutanese, 12 September 2012)

The interview series covered in three parts generated at least 145 comments. Dasho Karma Ura, President of the Centre for Bhutan & GNH Studies (CBS), in a rebuttal of sort interview arranged by the same newspaper expressed analysis of 97 comments to the critiques as 58% in favour of David's argument, 34% against and 8% neutral. However, Dasho stated that Dr David's views are "not fundamental in a conceptual sense" but opens contemporary issues for the discussion. The blatant and straight forward expressions could have been a result of adjustment visiting the third world country from the first world and mistaken to be in the second world. In any case, the timing of publication is noteworthy. The first series of part 1 was made freely accessible in the public domain on 12 September 2012, exactly after two months of recognition of Happiness and well-being by the UN General Assembly, as universal goals which shall form part of public policy objectives. The agenda was moved by Bhutan as part of the GNH worldview discussion. The agenda discussed in the highest international forum was yet to have penetrated the corporate world. What is more notable in the interview statement is how some top corporate executives were thought to have interpreted GNH as simply 'environmentally friendly socialism'.

It is totally an indicative expression that business executives especially of the west are '*profit-oriented*', but it cannot be generalised based on this source alone. The businesses and corporations should not and cannot exist just for profit, but get well integrated as part of the wider social system. Mintzberg (1983) agreed that Corporate Social Responsibility (CSR) has been "discussed academically by professors, pragmatically by businessman, politically by public representatives; approached philosophically, biologically, psychologically, sociologically, economically, and even aesthetically". Montiel (2008) who reviewed and traced

different definitions of Corporate Social Responsibility (CSR) and Corporate Sustainability (CS) published in top journals have observed that most of the CSR articles were published between 1970 and 1990 while Corporate Sustainability related writings appeared later in 1990s. According to International Organization for Standardization (2010):

...Social Responsibility is defined as the responsibility of an organization for the impacts of its decision and activities on society and the environment, through transparent and ethical behaviour that contributes to sustainable development, including the health and the welfare of the society; takes into account the expectations of the stakeholders; is in compliance with applicable law and consistent with international norms of behaviour; and is integrated throughout the organization and practiced in its relationships

This definition of Social Responsibility captures every essence of interdependence among the organisations and other peripheral agents called stakeholders. There are also clear evidence that those organisations taking the social responsibility are also '*sustainable*' in the long run. The CSR very well fits into the GNH paradigm. One of the respected figures known for commitment, dedication and integrity for his public service delivery role in Bhutan, and who was conferred Bura Marp (Red Scarf) by His Majesty the Fourth King, Honourable Dasho K. Wangdi (Personal Communication, June 24, 2021) expresses that GNH of Business should mean doing business that shall ultimately result in assuring sense of win-win accomplishment without any guilt, but through fair practices such as upholding business values and being respectful of laws. The Corporate or business Social responsibility is inevitable part of GNH in corporation. Based on the data gathered from Bhutanese business and government leaders, observation of conferences and meetings, media and literatures, Sebastian (2018) found that GNH world view based on Buddhist philosophy offers a much '*matured*' approach to ethical and sustainable decision making in comparison to traditional CSR. This is because GNH views reality and self to be interdependent with causes and effects as mutually conditioning. The author points out that this view in business results '*going beyond CSR*'. Thus, the

Organisation commitment and contribution for the cause of Socio-culture-environment can be factored in as for GNH in Corporation construct. The financial contribution in the areas such as environmental conservation and socio-cultural enhancement will be considered as well.

For any organisation, the '*organisational personality*' rests on its values, mission, and objectives, and most importantly the impression it creates in the public eyes and the stakeholders. The creation of Druk Holding and Investments (DHI) to hold and manage Bhutanese public corporations is a vision by itself of the visionary king for the Bhutanese and meant for all time to come; to live and lead the holistic organisational responsibility, everyone including the executives, leaders, managers, and employees of the public organisation have the roles. Thus, living the GNH values in businesses is critical for everyone involved directly or indirectly associated with the organisation. Hence, it should be the organisational values when all put together. The business values are generated from the Vision, Mission, and Objectives (VMO) statements of each public companies selected for the study. On analysis, it is inevitably clear that the following values cut across all the DHI and its owned companies: ***Integrity*** (and Honesty); ***Teamwork*** (Mutual Respect, Care); ***Leadership***; ***Professionalism & Excellence*** (Growth & Development, Responsibility, Transparency and Accountability; Prudence and responsiveness; Quality Standard); ***Innovation & Creativity***, and ***Health & Safety***. Thus, these organisational values shall form important aspects of the GNH in Corporation.

There are several studies being conducted to analyse the factors related to workplace happiness and job satisfaction. Dahiya and Raghuvanshi (2021) in their study found that work engagement and job satisfaction were the resultant enablers of maximum casual factors among 12 factors of authentic work climate, organisational virtuousness, person-organisation work fit, work engagement, job satisfaction, organisational learning capability, participative decision making, meaningfulness in work, relational quality, transformational leadership, perceived organisational support, flow at work and intrinsic motivation. These findings are based on the method of multi-criteria decision-making approach known as DEMATEL. In another study by Belloni et al. (2016) based on the data related to economic conditions, retirement and mental health collected during 2004-2013 across 10 European



countries, it was found that retirement improved mental health of male workers (but not women workers); and the effect was stronger for blue-collar workers employed in regions severely hit by economic crisis. Thus, it is conclusive that economic factor and living standard influence health even after the retirement. This truly indicates the existence of association among economic factors, health, happiness, and well-being.

Keyes (2002) states that the mental health continuum is a composite of complete and incomplete mental health; adults with complete mental health exuded through positive emotions, functioning well psychologically and socially are known to be ‘flourishing’ in life with higher levels of well-being. In the opposite of the continuum with incomplete mental health is ‘languishing’ conceived to be of low well-being. In his study, Keyes (2002) noted that 28 percent of languishing adults had major depression while only less than 5 percent of flourishing adults had major depressive episode during the past year prior to his research.

Thus, employee happiness and satisfaction should be considered in any organisational setting. So, another essence for the GNH in Corporation is employee happiness and wellbeing. Thus, the GNH in Corporation variable shall bear the essence of business values, Socio-Culture commitment and employee happiness captured within the domains of Living Standard; Education & Training; Health; Psychological Well-being; Concern for Culture; Community Vitality; Time Use; Good Governance; and Concern for Environment

## **6. Leadership, GNH in Corporation and Employee Performance**

The Leadership in the Bhutanese companies has the pivotal role in creating GNH in Corporation while also fulfilling the Corporate Performance benchmark at the same time. However, behind any corporate success, one important factor is the employee performance; after all, corporate performance is simply the aggregate result of efficiency, effectiveness, productivity, and professionalism of each individual employees beside other resources. Employee Performance is the basis of overall Corporate Performance. This is well understood through the Performance Management System how each employee’s performance is tracked, evaluated and rewarded. Hence, Human Resource Development and Human Resource Management become crucial functions of any organisations. According to Garavan et al. (2000) contemporary Human Resource Development can be understood in terms of

capabilities-driven, psychological contract, and learning organisation perspectives. The degree of inclination towards these perspectives determines the process of acquiring the best potential and performance from employees. Based on the interaction and data collected from academicians, corporate practitioners, industry professionals and relevant theories, Pradhan, & Jena (2017) developed the triarchy model of employee performance comprised of task performance, adaptive performance and contextual performance. The measure of employee performance was validated using the data from Indian manufacturing and service industries. There are abundance of literatures suggesting two forms of employee work performance: “in-role”, which refers employee’s action in fulfilling job description, and “extra-role” which goes beyond the formal requirement. The GNH in Corporation or Employee performance as outcomes is dependent on Leadership in the organisation.

One of the benefits of corporation is its ability to immensely contribute to the economy and its capacity to disburse and distribute profit to its shareholders in the form of dividends (Truitt, 2006). Hence, the measure of corporate success in the form productivity, efficiency and effectiveness is one useful process that cannot be ignored. In the United States, the companies’ performance can be gauged through S&P 500 index. Put simply, the S&P 500 (Standard & Poor’s 500) Index, is a market-capitalization-weighted index of the 500 largest publicly traded companies in the United States. However, the companies’ progress is generally considered holistically based on both financial and non-financial performances. In the context of DHI portfolio companies, Kharka et al. (19 January 2016) clearly express that Corporate Performance at corporate level covers target setting and monitoring & evaluating in performance areas of financials, customer service, corporate governance and, policy directed targets. These are but the indications that Corporate Performance is measured based on both financial and non-financial scores. This in fact is linked to the national level umbrella policy of GNH. The Ministry of Finance-Royal Government of Bhutan (2019) specifies that State owned enterprises should undertake Annual Performance Compact (APC) to fulfil their financial and non-financial targets. The leadership steers corporate performance through employees.

There are evidences that leadership in the organisation influences Employee Performance. Yang and Wei (2017) empirically concluded that ethical leadership positively influenced employee task performance in the Chinese companies. The job quality, efficiency, judgement, job knowledge and creativity in executing the given duties formed the overall job performance variable, and the supervisors rated their subordinates. Similarly, study conducted in Jakarta, Indonesia, Rozi et al. (2020) found that leadership has positive and significant effect on employee performance; leadership could predict almost 67% employee performance variance with strong correlation coefficient of 0.817; the employee appraisals formed the data for employee performance. In the context of India, Pradhan, & Pradhan (2015) tested hypothesis that “transformational leadership will positively relate to [employees’] Contextual Performance” based on the data from IT professionals across India. They accepted hypothesis based on the standardized b coefficient of 0.32 ( $p < 0.05$ ) which meant the contextual performance is determined by transformational leadership. The Contextual performance is an ‘extra-role’ performed beyond the formal task requirement. According to the study conducted by Khan et al. (2020), transformational leadership is found to have positive impact on ‘civic virtue behaviour’ as well. In terms of entrepreneurship and innovation, transformational leadership is associated with innovation culture, innovation strategy, new product development process and product innovation (Sattayaraksa & Boon-itt, 2014) while transformational CLTs (Culturally Endorsed Transformational Leadership Theories) and sustainability conditions of society positively influence the likelihood of individuals becoming social entrepreneurs; the effectiveness of transformational CLTs matters more for social entrepreneurship when the sustainability of society is low (Muralidharan & Pathak, 2018). The civic virtue behaviour, job satisfaction, organisational commitment, employee engagement, employee creativity and innovation are all linked to the efficiency and productivity which enhance Employee Performance.

Sokoll (2014) who conducted research on university employees of America found that ‘*Servant Leadership*’ had a significant and positive correlation with employee commitment to the supervisor. The servant leadership also determines the level of trust of the employees toward their organisation. It was noted that Trust in

Organisation (TIO) is an immediate outcome of servant leadership, upon on which the trust gives rise to lower Intention to be late for Work (ILW) and higher creative and service recovery performances. These reveal that servant leadership mitigates ILW and boosts both creative and service recovery performances through TIO (Karatepe et al., 2019). The outcomes of the self-leadership include innovative work behaviour and entrepreneurial orientation, affective responses, and work performance. The '*self-leadership*' skills is positively related to both self and supervisor rating of innovative work behaviour (Stashevsky et al., 2006) which corresponds with better affective response and improved work performance (Stewart et al., 2011), and takes full mediating role in the relationship between participants' perceptions of entrepreneurial orientation and innovative work behaviour (Kör, 2016).

There are also many studies conducted to analyse and understand the effect of leadership and employee happiness. Northouse (2019) states that corporate organisations seek leaders who can bring special assets to their organizations and, ultimately, improve the bottom line. The bottom line is not necessarily the profit alone but the sustainability of the business itself through employee happiness. The research conducted by Salas-Vallina et al. (2020) on employees of five largest banks in Spain and Italy found that '*Inspirational Leadership*' has a direct and positive effect on Happiness at Workplace. Yang (2014) based on the data gathered from the alumni of National Chiao Tung University of Taiwan and who work in different organisations concluded that '*ethical leadership*' had a positive and significant relationship to employee well-being through the mediation of job satisfaction although only a partial direct relationship between ethical leadership and employee well-being could be ascertained; also it was found that the significant and positive relation exists between ethical leadership and life satisfaction. Semedo et al. (2019) concluded that Authentic Leadership positively and significantly influence employee affective well-being, implying that employees perceiving their leaders' authentic behaviour are happier at work. Chaiprasit, & Santidhiraku (2011) identified factors which effect most for the happiness of the employees working in Small and Medium-sized Enterprises (SMEs) in Thailand. Their analysis authenticated that the factors of relationship, quality of work life and Leadership affect employee's happiness the most. The study conducted by Tang et al. (2015) on the major restraint, Hospitality Industry in China have

concluded that there is a positive relationship between ‘*ethical leadership*’ and leader-follower value congruence. The regression of moral identity, and moral on to ethical leadership showed the statistically significant relationship (O’Keefe et al., 2019). The research conducted on employees of pharmacy firms in Thailand concluded that ethical leadership is also correlated with emotional labour (surface and deep acting), follower’s personality traits, followers’ perceived stress and follower’s performance (Mekhum, 2020).

For sustainable and healthy organisation ‘job satisfaction’ is inevitable. Based on the analysis of data collected from employees working in 12 private banks in Myanmar, Myint et al. (2016) concluded that “supervisor”, “Co-workers”, “Compensation” and “Job Contents” are the factors for job satisfaction. These factors were carefully grouped into different factors after principal component factor analysis with varimax rotation. Job satisfaction is part of GNH in Corporation variable. Mafini and Dlodlo (2014) also found that satisfied employees are more committed to their work, participate genuinely, positively, and effectively in work-related activities and are less likely to leave the organisation. Conceptually job satisfaction is “pleasurable or positive emotional state resulting from the appraisal of one’s job or job experiences” and involves cognitive, affective, and evaluative reactions or attitudes. The commonly recognised dimensions of job satisfaction include ‘the work itself’, ‘supervision’ ‘pay and remuneration’ and ‘co-workers’ (Luthan, 2011). Mat et al. (2019) concluded that transformational leadership and psychological safety influence employee engagement. The study conducted by Samanta, & Lamprakis (2018) on Greek Public sector ascertained that transformational Leadership strongly and positively determine both the “followers’ perceived leadership effectiveness” and “followers’ job satisfaction”.

Although the present research is not about the result of job satisfaction alone (but it forms part of the GNH in Corporation) there is empirical evidences that job satisfaction positively effects psychological well-being (Karabati et al., 2019; Wright, & Bonett, 2007), organisational commitment (Ahmad et al., 2003), citizenship behaviour (Djaelani et al., 2020), and performance (Lam et al., 2015). The job satisfaction and employee psychological well-being fit in one of the nine domains identified for the GNH in Corporation. On comparison, Bhutanese corporate



employees seem to have been happier than general population as Choiden (2016) noted that average life satisfaction score of employees of two telecommunication companies was 6.82 (on the scale of 0 to 10), which was 0.77 higher than that of general public in 2010 which was based on GNH Survey; however, in 2015, the subjective happiness of later has increased to 6.88 even surpassing corporate employees' score of the past. But whether corporate employees are still happier is yet to be known. The other domains of GNH in Corporation include training and education, health, living standard, time use, good governance, cultural diversity and resilience, Community vitality, and ecological diversity and resilience. Study conducted on Chinese army aviation unit subordinates (Lin et al., 2020) found that servant leadership had positive effect on job satisfaction through work empowerment; same conclusion was drawn by Djaelani et al. (2020) based on the research conducted on lecturers of Islamic University in Indonesia.

One of the objectives of the present research is to find out if Leadership effect Employee Performance through GNH in Corporation. Sebastian (2018) states that "in Bhutan's case the GNH approach in business lends itself to supporting businesses and their leaders to operate with proactive, societal and *planetary leadership*". This proactivity level correlates with the GNH domains which are aimed at achieving common goals at organisational and societal level at large. Although Corporate Social Responsibility (CSR) is not happiness per se, it is one of the sub-components of GNH in Business variable; and it does influence performance as well. On analysis of data from employees of one reputable financial institution in Latvia, Story and Castanheira (2019) found that both external and internal CSR positively and significantly associated with supervisor rated individual employee performance, attitude towards their job and organisation. The CSR was categorised as internal (organisational practices related to betterment of working conditions) and external (activities for protection of the environment, community development, sustainability, and philanthropic activities). This again corresponds with long-term goal of organisational reason for existence, going beyond the time-bound corporate and employee performance. The leadership in business setting matters. However, to contextualise, the present section of literature is concerned with mediating role of GNH in Corporation on the relationship between Leadership and Employee

Performance. First, the influence of leadership on employee performance and on the workplace-happiness is determined as explained in the previous paragraphs. So, now, the point of interest is to find out the influence of GNH in Corporation or workplace happiness on employee performance. In this line of discussion, Semedo et al. (2019) found that the employee affective well-being determines affective commitment based on the cross sectional study conducted in Cape Verdean organizations on the islands of Santiago and São Vicente. There are other sources clearly indicating the evidence that GNH in Corporation can be determined by Leadership in the organisation, while it can also predict employee performance. Hence the following hypotheses are proposed:

**H1:** Leadership influences Employee Performance

**H2a:** Leadership determines GNH in Corporation

**H2b:** GNH in Corporation impacts Employee Performance

- GNH in Corporation mediates the effect of Leadership on Employee Performance

## **7. Leadership, Psychological Capital, and Employee Outcomes**

Resources are inevitable for performance in any organisation. For example, Nge et al. (2015) have ascertained that firm resources comprised of human, technological, financial and physical resources have direct and statistically significant effect on performance benefits; the finding was based on garment industry in Myanmar. Other studies derived similar results. But there are only a few instances where psychological capital is considered part of organisational resources. However, Positive Organisational Behaviour (POB) is becoming trending field of study. Luthans and Youssef (2007) noted that many recognisable methods and approaches to positivity in the workplace have started appearing in recent times. And, one among these is the ‘positive organisational behaviour’, the very concept contributed by Fred Luthans. The positive organisational behaviour is defined as “the study and application of positively oriented human resource strengths and psychological capacities that can be measured, developed, and effectively managed for performance improvement in today’s workplace” (Luthans, 2002). Study conducted by Luthans

and Youssef-Morgan (2017) confirmed that positive psychological resource capacities of hope, optimism, and resilience have influence on the work-related employee outcomes. The outcomes include performance, job satisfaction, work happiness, and organisational commitment. In the field of positive organisational behaviour, psychological capital (PsyCap) is the main construct composed of four positive psychological resources: Efficacy/Confidence, Optimism, Hope and Resiliency. Luthans, Youssef, et al. (2007) states that *Psychological Capital (PsyCap)* is:

...an individual's positive psychological state of development and is characterized by: 1) having confidence (self-efficacy) to take on and put in the necessary effort to succeed at challenging tasks; 2) making a positive attribution (optimism) about succeeding now and in the future; 3) persevering toward goals and, when necessary, redirecting paths to goals (hope) in order to succeed; and 4) when beset by problems and adversity, sustaining and bouncing back and even beyond (resiliency) to attain success.

Cavus, & Gokcen (2015) point that psychological capital emphasizes personal psychological sources with their four basic components and carries a changing feature based on situations rather than having a stable characteristic feature. The definition of resources in the organisation keeps expanding from traditional economic capital to human (of intellectual) capital to social capital to now psychological capital (Luthans, & Youssef, 2004). In fact, this is a creative and strategic shift. Although financial and tangible assets are still important, the organisational focus on 'who are employees' keeps gaining momentum and importance together with 'what employees know' and 'who they know'. Hence, as pointed out by Luthans, & Youssef (2004), positive psychological capital goes beyond human and social capital. Does organisational Leadership play any role in enhancing employee psychological Capital? The data gathered from employees working in commerce organisations of Portugal was analysed by Rego et al. (2012) using LISREL software and the maximum likelihood estimation method of the Structural Equation Model. The authors confirmed that Authentic Leadership relates positively with both Psychological Capital and employee creativity. Gooty et al.

(2009) have concluded that followers' perception of transformational leadership can develop their own Psychological Capital. The finding was based on the information collected from marching band members of one major university in the United States. What is also relevant is the influence of Psychological Capital on Employee Performance. Sweetman et al. (2011) based on the data obtained from heterogeneous working adults derived result that the components of Psychological Capital, hope, resilience, efficacy and optimism predict the creative performance; similar result was also found by Taştan (2016) in Turkey. Based on the study conducted among the employees of three Chinese factories, it was concluded that workers' psychological capital of hope, optimism, and resiliency were significantly associated with their performance, rated by their supervisors (Luthans et al., 2005). Gooty et al. (2009) validated that the Psychological Capital influences employee in-role performance.

Considering the results in the literature, employee Psychological Capital is influenced by Leadership on one hand, and it influence employee performance on the other. Hence it is clear enough that Psychological Capital can mediate the relationship between leadership and Employee Performance. Rego et al. (2016) derived result that psychological capital, especially self-efficacy, hope and optimism mediate the relationship between authentic leadership and organisational commitment, one determinant of employee performance. Through a research conducted in Lahore, Pakistan on the employees representing different sectors of manufacturing, banking and finance, services, non-for-profit, telecommunications and higher education, Bouckenoghe et al. (2015) established the mediating role of psychological capital on the relationship between Ethical Leadership which was measured through Ethical Leadership Scale developed by Brown et al. (2005) and employee in-role job performance. Malik, & Dhar (2017) also concluded that psychological capital catalyses the Authentic Leadership and employee extra role behaviour relationship; the result was based on the data collected from employees of 42 small and medium size hospitals in India. The result based on a study conducted in high-end hotels of central and eastern black sea regions of Turkey reveals that authentic leadership has positive effect on both work engagement and psychological capital while the later also has at least partial mediating role in the authentic leadership's influence on work engagement (Ciftci, & Erkanli, 2020).

In terms of the work place happiness and well-being as the outcome, Park et al. (2017) confirmed through the data obtained from eight large sized firms in South Korea that “empowering” leadership has influence on job engagement both directly and indirectly through Psychological capital. Although GNH in Corporation or Workplace happiness was discussed in the earlier section, it is important to relate it with Psychological here. There are evidences that happiness at work converts into enhanced psychological resources, and vice versa. A study conducted on Hungarian teachers found that there was existence of correlation between workplace well-being and happiness and with inner psychological resources of hope and optimism (Kun & Gadanez, 2019). The similar result was also observed by Avey et al. (2010) that Psychological Capital was related to the both measures of Psychological well-being (PWB). The PWB was measured using two instruments, the Index of PWB and the General Health Questionnaire (GHQ) although the relation seems to be more stable and stronger for Index of PWB than GHQ. Hence, GNH in Corporation is expected to stimulate the employee psychological capital. It is only logical to deduce that these variables are likely to act both parallel and serial intervening variables in the relationship of Leadership and employee performance. The following hypotheses are proposed:

**H3a:** Leadership effects employee’s Psychological Capital

**H3b:** Employee Psychological Capital impacts employee’s Performance

**H4:** GNH in Corporation determines employee’s Psychological Capital

- Psychological Capital will mediate the effect of Leadership on Employee Performance
- **Overall Hypothesis:** GNH in Corporation and Psychological Capital mediate the effect of Leadership on Employee Performance

## **8. Employee Personality as Moderating Variable**

Although the concept of personality has been debated for very long time, by the late twentieth century, personality seemed to have developed into concrete definition with widely accepted model. McCrae and Costa (2003) express that with the rediscovery of Five Factor model (FFM) in 1980s which demonstrated



comprehensive personality trait structure covering “all the traits identified in common language and in scientific theories” led to the end of unfruitful rivalry among different trait models. For the conception of personality, trait has been the centrepiece which inherently denotes consistent behaviour. It is stated that individuals are unique and can be characterized in terms of relatively enduring and lasting patterns of thoughts, feelings, and actions which are determined by the quantitative assessment of traits showing degree of cross-situational consistency (McCrae & Costa Jr, 2008). In their study on the history of modern personality, Barenbaum and Winter (2008) observed that trait theorisation and research has focused on questions pertaining to the number, nature, and organization of basic traits using strategies of quantitative techniques of factor analysis and mathematical model, a priori theorising and idiographic approach focussing on individual trait patterns. The Five Factor Model fits well into this personality theorisation as explained in the following.

The Five Factor Theory (FFT) developed by McCrae, & Costa (2003) which in turn was based on Five Factor Model (FFM) begins with observation of stability of traits. Their personality system of FFT is composed of three central components: 1). Basic Tendencies (Neuroticism, Extraversion, Openness, Agreeableness, and Conscientiousness), 2). Characteristic Adaptations (culturally conditioned phenomena, personal strivings, attitudes), and the 3). Self-Concept (Self-schemas, and personal myths). McCrae and Costa Jr (2008) state that “in a narrow sense, the five-factor model of personality is an empirical generalization about the covariation of personality traits.” The research conducted by Roccas et al. (2002) who used the NEO Personality Inventory (NEO-PI) for measuring personality, confirmed through factor analysis that their data supported five factor structure of personality. Now the point of interest is the connection between ‘*personality*’ and ‘*psychological capital*’. Personality and the psychological capital are the two different constructs. While personality is inherently construed consistent and stable behaviour, the psychological capital is a dynamic state of positive psychological capacities. Although distinctive in properties, the two variables tend to be related. In their research to study relationship between psychological capital and personality across culture of eastern, Nordic and South Europe, Brandt et al. (2011) confirmed the existence of the relatedness. In specific terms, it was found that the personality factors

of extraversion, intuitiveness and thinking type in particular scores high in all the psychological capital dimensions; of course, this does not necessarily mean causality. The personality was measured based on the Myers-Briggs Type indicator (MBTI) instrument. The MBTI classifies personality into 16 different types based on the level of four preference dimensions of Extraversion (E) or Introversion (I); Sensing (S) or Intuition (N); Thinking (T) or Feeling (F); and Judging (J) or Perceiving (P). In another study in Turkey Bozgeyikli (2017) concluded that teachers' personality traits, except neuroticism, were found to be associated with optimism, resilience, hope, and self-efficacy. The similar result was obtained by Yildiz (2018) who have interpreted data provided by employees of manufacturing enterprises in same country, Turkey.

Employee personality is also connected with how they perceive their supervisor's leadership and the performance at work. Analysing the survey conducted on the employees of one financial service company, Felfe, & Schyns (2010) concluded that the followers' personality influences the perception of transformational leadership and commitment to the supervisor. The followers' personality was measured using German short version of NEO-PI while Multifactor Leadership Questionnaire (MLQ 5X short) was used to assess transformational leadership. The identical result was also generated based on the data collected from employees of three different Dutch companies and students of a Dutch university (Schyns, & Sanders, 2007). Similarly, Stelmokiene, & Endriulaitiene (2015) found that subordinate neuroticism and social identification predict how they perceive transformational leadership, with extraversion and agreeableness linked to social identification. The global transformational leadership scale, social identification questionnaire and NEO-FFI were used as instruments to measure employees' transformational leadership perception, social identification, and personality, respectively. The relationship between personality and their performance at work is established based on many studies. Analysing the research data generated from employees of a retail bank and a hospital in the United States, Harris, & Fleming (2017) established that the conscientiousness among other five factors of personality significantly influenced the productivity propensity while agreeableness and conscientiousness determined self-rated performance in both the bank and hospital samples.

An analysis of survey data from middle management members and their subordinates of Chinese companies, Yang, & Wei (2017) found that employee proactive personality moderated the relationship between ethical leadership and employee task performance which in turn was mediated by organisational identification. The conclusions were drawn based on multiple regression analysis. The personality also seems to relate with how they perceive happiness as well. Pishva et al. (2011) who have collected data from one University of Medical Sciences in Iran concluded the positive correlation between extraversion personality and happiness, while Neuroticism and Psychoticism were negatively related to happiness. The authors used Eysenck Personality Questionnaire and Oxford Happiness Inventory as instruments for measuring Personality and Happiness respectively. Although employee personality can influence other variables and their relationships, personality itself is not a result of other variables; hence, based on its influencing effect but not effected, it is designed as ‘moderating’ variable for relationships among other independent and dependent variables. Hence, the following hypotheses are stated: Employee Personality moderates the relationship between:

**H5:** Leadership and Employee Psychological Capital

**H6:** Leadership and GNH in Corporation

**H7:** Leadership and Employee Performance

### **Conceptual Framework**

The conceptual framework of the study is developed as depicted in figure 1. The ‘Leadership’ variable will be composed of four dimensions: Behaviour, Skills, Awareness, and Character. The other main variables are GNH in Corporation, Psychological Capital, and Employee Performance. The Employee Performance for this study will be based on the survey questionnaire and the actual Performance evaluation scores (in the form of performance band). The GNH in Corporation variable will be based on the nine domains of GNH model designed to measure employee happiness, application of business values in the organization and organizational commitment for social, environment and culture. In the overall research framework, Leadership is designed to be an independent variable while

Employee Performance shall be dependant variable. Within this independent-dependent continuum are GNH in Corporation and Psychological Capital (Efficacy, Optimism, Hope & Resiliency, which fall under ‘Positive Organisational Behaviour’) positioned to be intervening or mediating variables. Another variable is ‘Employee Personality’ whose moderation effect will be tested in the relationships between Leadership and Employee performance, GNH in Corporation and Psychological Capital. The ‘Personality’ is based on Big Five Personality Traits theory. Hence, in this research theoretical model, the Leadership, GNH in Corporation, Psychological Capital, Employee Performance and Employee Personality are variables of interest for the study. Accordingly, the following Research Conceptual Framework has been generated.

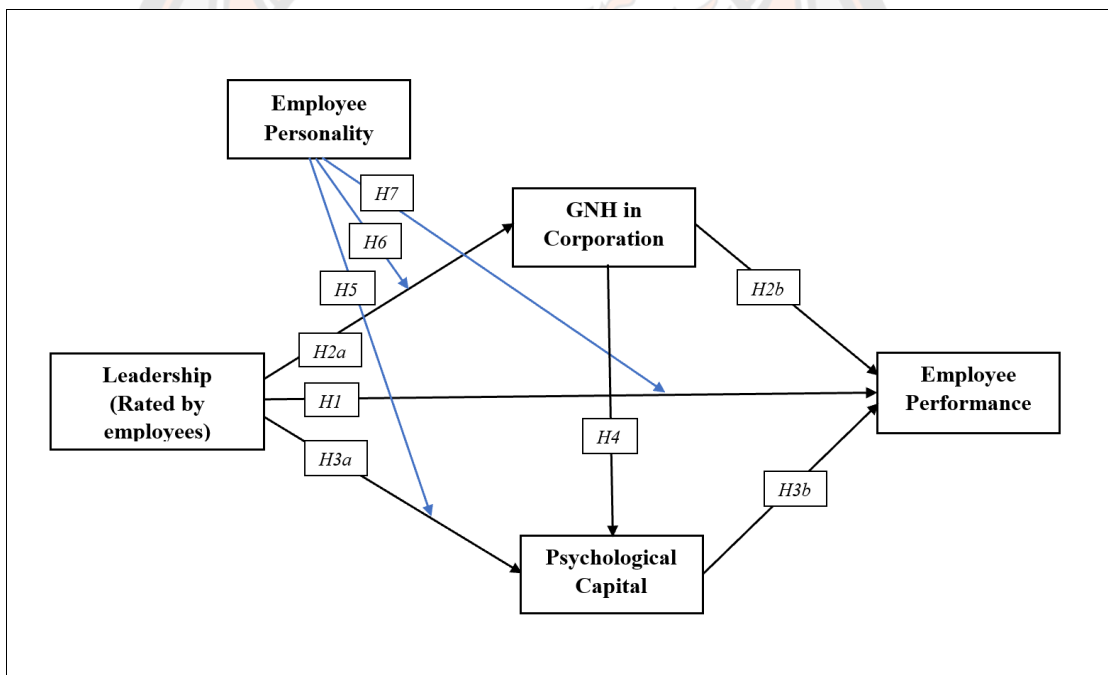

**Figure 1 Proposed Conceptual Framework**

### **Chapter Summary**

This chapter first discusses Bhutan in the context of Gross National Happiness in terms of its four pillars of good governance, economy, socio-culture, and environment. It contextualises and provides connections that GNH in Corporation is one of the important variables. The other section under the review of literature is necessarily academic which aligns with the very scope and objectives of the topic. The operational definitions for variables of the study are derived based on the existing theories in the literatures. The relationships among variables of leadership, happiness [GNH in Corporation] and employee performance are also explored and deduced based on the current academic sources. Also, the employee psychological capital and employee personality as mediating and moderating variables respectively for leadership and employee performance are studied. The hypotheses and conceptual framework are thus accordingly derived as a blueprint for the study.

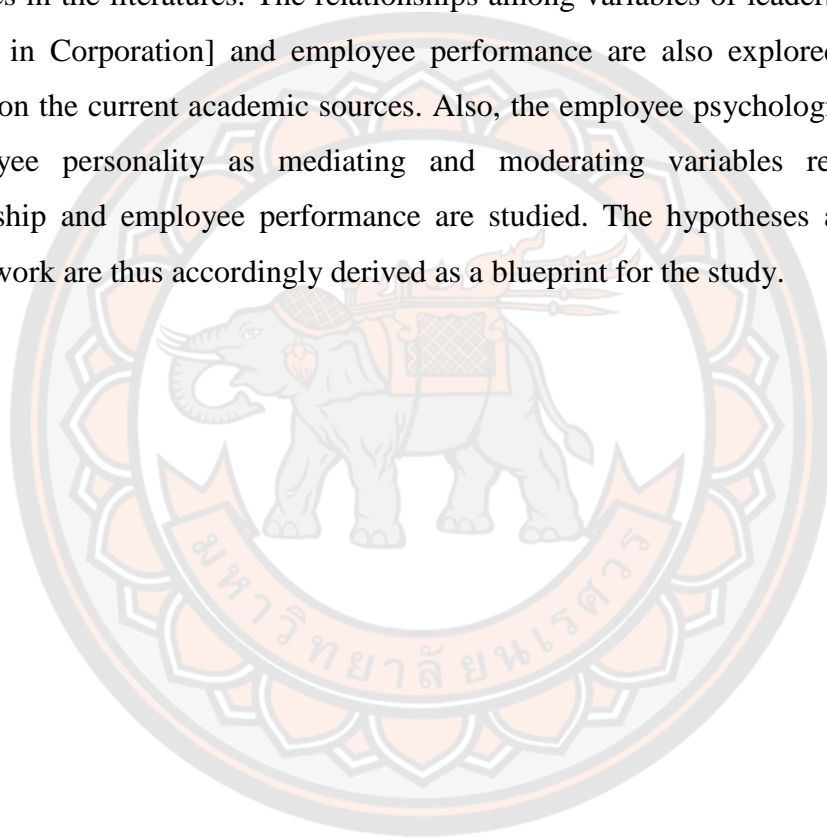



## CHAPTER III

### METHODOLOGY

#### **Methodology Overview**

Among many, the most common purposes of social research are exploration, description and explanation (Babbie, & Roberts, 2018). The goal and intention of the enquiry determines the design of the study. Any research is broadly categorised either as Quantitative or Qualitative; of course, mixed method is increasingly gaining popularity. The quantitative involves studies that make use of statistical analyses to obtain their findings through formal and systematic measurement and the use of statistics while qualitative research does not use statistical analysis tools to quantify their results; qualitative studies on the other hand use methods such as interviews and observations (Marczyk et al., 2021). The present study aligns well with Quantitative research strategy, as the measured data are analysed deductively to generate the results and conclusions although the methodology may seem like ‘convergent-parallel’ approach. The current research design complies with the research philosophy of ‘Positivism’. The underlying principle for this study was that the knowledge can be measured, quantified and conclusive information be generated deductively. Another important aspect of this research design was that the study framework was developed based on the existing theoretical foundations. Thus, the study was not designed to observe first and create meaning through interpretation, ignoring the ‘Constructivist’ worldview. The main variables for this study include Organisational Leadership (rated by subordinate employees); GNH in Corporation, Psychological Capital, and Employee Performance. In the overall research framework, Leadership and Employee Performance were placed as the predictor and outcome variables respectively; GNH in Corporation and Psychological Capital are intervening or mediating variables which served both as dependent variable (for Leadership) and independent variables (for Employee Performance). Another variable ‘Employee Personality’ was designed as a moderating variable in the relationship pairs of Leadership-GNH in Corporation, Leadership-Psychological Capital, and Leadership-Employee Performance.

### **Data Collection tools and Measures**

In terms of quantitative data interpretation, the research findings were based on primary information collected from employees while interview data from respective HRD Heads were used as rather as supplementary. The structured survey questionnaires were developed taking research conceptual model into consideration and integrated with the already established and validated instrument wherever relevant. Employees of different categories were asked to rate the leadership of their immediate Supervisor or manager (Unit/section head; Division Head; Department Head or 'Other') that they report to. The option of choosing Chief Executive Officer (CEO) as direct manger, supervisor or leader was not included in the questionnaire as the subject of the study was regular employees only. The subordinates of the CEO in the Bhutanese Corporations are usually Directors or General Managers who are employed for certain duration on Contract terms; they are not necessarily part of the regular employee pool. A few regular employees who are directly under CEO, such as staff under secretariat, internal audit or legal unit had the option to choose 'Other Category'. The aggregated leadership rating score for these heads (supervisors, managers or leaders) by their respective subordinates were indexed to generate the overall organisational leadership. The 'Employee Performance' is composed of actual performance band (The annual IWP Score of the past year), and the self-rated performance scored through Likert scale items. Employees were asked to rate their 'in-role' and 'extra-role' items in the questionnaire covering three dimensions of 'task performance', 'contextual performance', and 'counterproductive work behaviour'; the research participants were also asked to indicate actual performance band they scored in their last annual performance evaluation. The Performance band was classified as: **Unacceptable** (0.0 to 49.9); **Below Satisfactory** (50 to 64.9); **Satisfactory** (65 to 79.9); **Commendable** (80 to 89.9); and **Outstanding** (90-100). This DHI company-wide classification band was adopted to record the approximate actual performance as not many employees would remember the exact score. Hence actual performance score data was expected to be in ordinal form instead of continuous data.

The data pertaining to psychological capital was collected through the 'Psychological Capital Questionnaire (PCQ-12) Self-Rater Version', shorter form of PCQ-24 developed by Luthans, Avolio, et al. (2007). The instrument consists of 12

items with response choice put into a 6-point Likert scale (1= Strongly disagree, 2 = disagree, 3 = somewhat disagree, 4 = somewhat agree, 5 = agree, 6 = strongly agree). The 6-point scale is considered instead of 7-point after discarding the “Neutral (neither Agree nor Disagree)” label. The ethical permission to use this particular instrument was granted by ‘Mind Garden’\* after my research proposal was reviewed. Otherwise, this Psychological Capital Instrument (PCQ-12) is copy righted and not easily available in the public domain. (\*Mind Garden is “an international publisher of psychological assessment, leading the industry in providing tools to facilitate positive personal and organizational transformation” as mentioned in its website).

The ‘The Big Five Inventory-2 Short form (BFI-2XS)’ developed by Soto and John (2017) containing 15 items was selected to record ‘personality’ information. Respondents were asked to indicate their agreement on personality items as (1= Disagree Strongly, 2 = Disagree a little, 3 = Neutral, 4 = Agree a little, 5 = Agree Strongly). This BFI-2XS is the shortest and one of the two short forms of Big-Five Inventory-2 (60 items). Another short form BFI-2X contains 30 items. The Employee Performance data were collected through 18-item Individual Work Performance Questionnaire (IWPQ) developed by Koopmans (2015) which measure the three main dimensions of job performance: ‘*task performance*’, ‘*contextual performance*’, and ‘*counterproductive work behaviour*’. All items were rated on a 5-point rating scale (0 = seldom to 4 = always). However, the survey items for GNH in Corporation were adapted and developed based on GNH Framework and operational conception of the variable covering employee happiness, the information pertaining to corporations’ adopted business values and corporate commitment for socio-cultural aspects. For behaviour domain of leadership construct, items developed by Northouse (2021) were used after adaptation and contextualisation; items for other domains of skills, awareness and character were adapted or developed by the researcher.

The data collected from the respondents and the corporate organisation offices are quantified. For the analysis of the data, SPSS (Statistical Package for Social Sciences) and AMOS were used as the main statistical tools while the NVIVO software was used to arrange the interview data. However, interview data was used only as supplement for quantitative findings. The analyses were conducted at both descriptive and analytical level. To understand the status of Leadership and alignment

of GNH in the DHI owned corporations, Indices of the variables were generated for the descriptive information purpose. For the computation of Leadership and GNH in Corporation Indices, the adapted Alkire-Foster method of multidimensional measurement developed by Alkire, & Foster (2011b) was used. This method is normally used to measure multidimensional variable such as poverty, well-being and inequality based on 'dual cut-offs' identification strategy. According to Alkire, & Foster (2011b) the first cut-off called 'deprivation cut-off' is used to determine whether the person is deprived in each dimension and the headcount is taken into account; similarly, the deprivation benchmark was first set based on the Likert scale and its connotative measure. The next threshold 'Poverty cut-off' was determined by whether the person has enough deprivations to be categorised as poor. Again, to set the yardstick to qualify for poor was determined by the number of deprived domains.

Thus, for the Leadership and GNH in Corporation indices, the mathematical procedure identical to poverty indexation was used. The indices can be useful so that the direction for improvement can be ascertained in both variables. Also, it helps to monitor progress of achievement of the desired Goal. The method is adopted and used by the United Nations Development Programme (UNDP) to generate Multidimensional Poverty Index. The Leadership variable, specifically, the behaviour domain data is also analysed and interpreted through the lens of Managerial Grid of Blake, & Mouton (1964). The development of leadership and GNH in Corporation indices together with the leadership behaviour examined through Managerial Grid answer the first research objective and the question. The rest of the enquiries are established through the result of Structural Equation Model (SEM).

The Structured Equation Model was the main data analysis method involved to test the Research model statistically. According to Byrne (2016) the SEM takes confirmatory or hypothesis testing approach for the analysis of structural theory bearing on some phenomenon and the casual processes are represented by a series of regression equations. The SEM is very appropriate for social researches particularly involving latent or unobservable constructs, and has got many advantages; Collier (2020) states that SEM can analyse the influence of predictor variables on many dependent variables simultaneously; account for measurement error while also addresses error in predicting relationships, and it is capable of testing an entire model

instead of just focusing on individual relationships. The present research model generated result based on the research questions and research hypotheses from the structural model which include:

1. Relationship or association between: Leadership (exogeneous construct) and Employee Performance (Endogenous construct); Leadership (exogeneous construct) and GNH in Corporation (Endogenous construct); GNH in Corporation (Exogeneous) and Employee Performance (endogenous); and GNH in Corporation (Exogeneous) and Psychological Capital (Endogenous)

2. Intervening effect of GNH in Corporation and Psychological Capital on the relationships between Leadership and Employee Performance.

3. Moderating role of Employee Personality on the relationships of: Leadership and Employee Performance; Leadership and GNH in Corporation; Leadership and Psychological Capital

Prior to running the structural model, first the individual measurement models were tested as a qualification procedure. There were four measurement models situated around the four constructs. The leadership as higher order factor construct was defined by its four associated first factors of: 1). Behaviour, 2). Skills, 3). Awareness, and 4). Character. These first factors instead were modelled to serve as the reflective measures for the leadership construct and is consequently represented by the direction of lines to the first factors from the higher order latent construct named leadership. Similarly, the fundamental items were positioned as the reflective indicators in the form of 'item parcelling' to constitute the first factors. Kline (2015) states that when the indicators are reflective, the direction of influence flows from unobserved construct to its indicators, while the vice versa makes the indicators formative. The domain components of Hope, Efficacy, Resilience and Optimism (of Psychological Capital) and the nine domains of 'GNH in Corporation' are the composite indicators based on 'item parcelling'. According to Hau and Marsh (2004) the use of item parcel instead of items is common and has associated advantages as well. This is supported by the simulation study conducted to investigate the effect of item parcelling by Bandalos (2002) where it was found that item parcel resulted in better fitting solutions when items have unidimensional structure. Nasser, & Wisenbaker (2003) also noted that parcel solutions result better fit in terms of chi-



square to degrees-of-freedom ratio, Goodness-of-Fit Index (GFI), Expected Cross-Validation Index (ECVI), and Root Mean Square Error of Approximation (RMSEA), as well as two incremental fit indices, the Non-Normed Fit Index (NNFI) and Comparative Fit Index (CFI) compared to item solutions.

It is also critical to clarify that the ‘Employee Personality’ is included in proposed conceptual framework only but not in the Research Model. This is because, ‘moderating’ variable cannot be accommodated in the Visual Structural Equation Model (SEM) in AMOS. The moderation effects of personality were ascertained through analysis of ‘interaction effect’. The pre-determined a-priori was designed to fit flexible “Model Development Approach”; unlike, the model based on “Strictly Confirmatory Approach” which decides to ‘accept all’ or ‘reject all’ after testing, the model development approach is flexible. To put simply, this SEM model was tested based on the gathered data and was subjected to adjustment based on observance of any ill-fitting(s) within the model. The alterations and adjustments were based on modification indices.

### **Population and Sampling**

The population of the study was the fulltime/regular employees of Druk Holding and Investments Limited (DHIL) and six of its owned companies. The DHIL owned companies are the companies with full (100 %) ownership. There are 9 companies owned by DHIL in total. However, only the following companies, established in the year 2010 or earlier were considered for the research:

- 1. Druk Green Power Corporation Limited (DGPCL); 2. Bhutan Power Corporation Limited (BPCL); 3. Natural Resources Development Corporation Limited (NRDCL) under the ‘Energy and Resources’ category.
- 4. Bhutan Telecom Limited (BTL) and 5. Druk Air Corporation Limited (DACL) which falls under the ‘Communication and Transportation’ classification.
- 6. Construction Development Corporation Limited (CDCL) categorised under ‘Real Estate and Construction’.

Employees of these companies constitute the population of the study while the individual employees are the unit of analysis.

**Sampling Size:** Based on Recommendation of Rex B. Kline

Kline (2015) recommends that the N:q ratio should be 20 to 1 or 10:1, meaning 20 or at least 10 observations (N) for each parameter to be estimated (q). Schreiber et al. (2006) believed that 10 cases for every parameter estimated is enough. Bentler and Chou (1987) also pointed that sampling based on free parameters of the model will give more accurate calculation; they recommend at least 5 cases for each parameter estimate including error term as well as path coefficients. The sampling size was calculated based on the a-priori research design which had a total of 51 parameters to be estimated.

Considering the practicality and do-ability, the sample size determined using Kline's recommendations N:q ratio of 10:1 was finalised. In fact, this sample size was still higher than the 10 cases for each indicator (instead of parameter) suggested by experts such as Nunnally (1994); for 36 indicators as was in this study model, it would have required only 360 samples if this suggestion was opted. However, the sample size required based on Kline's recommendation of 10 cases for each parameter (N:q) was found practically reasonable. Thus, the target was to collect data from 510 employees (adjusted as 511 considering decimals after proportionate random sampling calculation). Since the population of the study was composed of different corporations with different sizes and considerable differences in the number of employees employed, the second phase after the determination of sample size was the stratification of the population based on the company or Corporation. This was to ensure balanced and proportionate representation from each corporation. The simple random sampling was appropriate for the selection of proportionate samples from each corporation. The advantage of a simple random sampling is that every member of the population has an equal chance of being selected with less sampling bias. The random number generator tool 'RAND' function of the Microsoft excel was used to identify the samples. Once the random number for each unit of samples was determined, the sampling frame (employee lists) was re-arranged based on the highest to lowest values of random numbers.

At the first stage, the overall sample size was determined which was then followed by stratification of the respondents prior to selecting samples from each corporation using simple random selection method. Hence, the proportionate stratified random sampling method was used. As per the Employee lists (sampling frames)

provided by the relevant authority of DHIL and its owned companies the total number of employees (excluding Elementary Service Personnel-ESP) was 5782. Hence, the known population of the study was 5782. The detailed information related to overall sample size and sample distribution from each corporation is summarised in Table 3.

**Table 3 Sample size distribution among the Companies**

	<b>Company/Corporation</b>	<b>Population</b>	<b>Sample Size</b>
1	DHIL	116	10
2	DGPCL	1623	143
3	BPCL	2350	207
4	BTL	563	50
5	NRDCL	482	43
6	Drukair Corporation Ltd	403	36
7	CDCL	245	22
	<b>Total Employees</b>	<b>5782</b>	<b>511</b>

### **Survey Instrument Validation**

The overall questionnaire is composite of multiple sub-questionnaires intended to collect data related to Psychological Capital, Employee Personality, Employee Performance (both Self-rated and actual performance), Leadership and GNH in Corporation. While the survey items for the first three variables have been already validated and in use, only the items for the last two variables needed validation. Hence, the statements for measuring Leadership and GNH in Corporation were put under the scrutiny of experts for validation. Prior to the collection of data, the survey instruments for Leadership and GNH Questionnaire were validated by a team of experts as the survey items were contextualized and developed by the researcher. Five experts, two practitioners and three academics, were identified in consultation with the research advisors; the nominations (through the form GS-12, requesting for experts to review research instrument) were finalized and approved by the Naresuan University Graduate School after reviewing candidates' expertise and the relevancy. The interesting fact about the team of experts was that all have

completed their Doctorate in Philosophy (PhD) and was a mixed composition representing both academics and practitioners. For the leadership variable alone 20 customized items were intended to measure the leadership 'Behaviors' (10 each for people centeredness and task centeredness), 16 for leadership 'Skills' (5 each for Technical Skills and Human Skills, and 6 for Conceptual Skills), and 6 and 5 items for leadership 'Character' and 'Awareness'. Similarly, the GNH in Corporation variable was initially composed of 41 items [added 3 more as suggested by experts and finalized with 44 items spread across nine dimensions]. All these items were validated based on the 'Index of Item Objective Congruence (IOC)'. The five identified experts rated each item as 1, 0, or -1 indicating 'Certain about consistency of item and the objective', 'Uncertain about consistency of item and the objective', and 'Certain about inconsistency of item and the objective' respectively. Based on this IOC validation, only five items under Leadership variable and eight items under GNH in Corporation scored  $\geq 0.8$  which in turn were above the required threshold score of 0.5; the scores of the rest of the items were 1. For IOC validation, only if the item scores less than 0.5, it should be deleted or rejected. Hence, all the items of the questionnaires were assessed and verified to be fit and valid. Thus, all items were retained for the actual survey. Also, before the start of actual data collection, reliability test for the instrument was conducted through pre-test data.

### **Data Collection**

The pre-test data was collected online from academics of the colleges under Royal University of Bhutan (RUB) in February-March 2022. The data collection was based on the proportionate stratified sampling. A total of 252 out of 267 identified participants responded the survey achieving response rate of 94.38% for pre-test survey. The sample size for pre-test data was determined using Taro Yamane formula with the population of 805 academics, and 0.05 margin of degree of error. The lists (sampling frames) of RUB academics were obtained from the Human Resource Division (under Registry Office), Office of the Vice Chancellor, Royal University of Bhutan. And it was found that the average time taken to complete the survey was 24 minutes and 19 seconds. The details of the pre-test reliability results are reported under the result section.

Similarly, for the actual or main research, the data was collected online using the survey sparrow form (paid subscription) after completing pre-test data collection. Although, the online questionnaire was prepared as Google form initially, the survey sparrow form was found to be most appropriate for both researcher and the participants especially in terms of survey administration, easy view, and navigation. The process of data collection began in March 2022 and was completed by June 2022. The sampling frames (list of DHI & its Owned companies) were acquired officially from each company after following and completing the due process. The researcher calculated the proportionate samples from each company after which the samples were randomized using the 'RAND' function in the excel as per the already determined sample size [based on a-priori Structural Equation Model]. All the employees under the separate seven lists (for DHIL and six companies) were arranged in descending order based on the values generated through randomization. To reduce the chance of missing data, the questionnaire items, and specific questions (except requiring contact details or other optional information) were earmarked 'compulsory or mandatory' through the system. Also, prior to administering the survey to the respondents, the online link was sent to at least four relevant experts for proof reading and necessary corrections.

Once the order of the lists and the questionnaire were ready, the survey began. In the first stage, the email request and the online link for the survey was sent to the identified employees; it was encouraging to note that majority responded in the first instance, and for those who have not responded were contacted through mobile phones. This has further increased the response rate. However, a couple of issues were noted in the process. Among the selected participants, a few expressed that they were either superannuated or separated from the company recently, while a countable few responded that they were posted to another organization under deputation and that their annual performance and supervisor rating would be ambiguous; still a few communicated that they were undergoing long-term professional development. Hence, in such instances, the next employees still based on the order of their ranking were contacted. Thus, the researcher made sure that the required samples are fulfilled. The details of the responses and response rate are reflected in the result section.



In addition to the survey questionnaire, data was also collected from the seven Head of the Human Resource and Administration through one-on-one interviews. Among the seven selected representatives of the corporations, almost all opted online session instead of face-to-face interview; one interview was conducted in person, face to face in the office though. The decision for interviewees opting online was due to the prevailing Covid-19 pandemic situation. And one online interview had to be halted prematurely due to the incessant rain and internet disruption during the ongoing session; the interviewee instead offered suggestion to provide the written interview; accordingly, a written interview was received after a few days later. The collection of interview data began on 8 June 2022 and the last interview was completed by 28 June 2022. The time taken for interviews ranged from 36.9 minutes to 70.2 minutes. In total 316.82 minutes (5.28 hours) were spent in carrying out six interviews (excluding one written interview). The interview data stored as audio-file were converted to text files by transcribing and, by translating. Since, interview was in a mix of both English and Dzongkha languages\*, no special transcription software was used. (\*Dzongkha is national and official language of Bhutan.) Thus, for the English, the audio was simply transcribed, while the use of Dzongkha had to be carefully translated. The analysis was thus based on seven text files [55 pages when all combined] containing total word count of around 20,000 excluding the questions. The NVIVO Qualitative Data Analysis Software (QDAS) was used to arrange the data for analysis. The information from interviews was used as a supplementary data for the quantitative findings from the analysis of survey data.

## **Data Management**

### **1. Data File Preparation**

Matthews, & Ross (2010) rationally states the significance of ensuring that data is complete and accurate as it can be, before start working with data. Preparing and processing data files for further analysis is important because even the perfectly designed research may end up with inconsistent data. This stage of task ensures the relevancy of the data and acts as a bridge between data collection and data analysis. Data editing, coding, classification, tabulation, and cleaning are some activities involved in processing and preparing data. The survey was closed on 14

June 2022 after required responses were recorded. The data stored in the inbuilt excel of the online survey was downloaded and used for data management. Most of the data such as demographic information and Likert data were stored in the form 'String/words' such as "Male/Female", "Strongly Agree/Strong Disagree". Since such data cannot be read by statistical Software, they were converted into numerical values through "coding". Although code book was prepared even before the data collection, transforming worded data into numeric was a scrutiny. The "find and replace" with "match case" was conducted carefully in converting information into numbers in the excel sheet. Once the master numeric data sheet was finalized, the data was imported to the SPSS (Statistical Package for Social Sciences) where all the variables were defined, labelled, and classified in the "variable view" tab. The next stage after having transferred the data into SPSS was "data Cleaning". Since, the responses were collected using online forms, there was no major issue of "missing data" and "outliers". This was ascertained through analysis of simple frequency distribution, and "maximum" "minimum" values of the variables. For instance, the 6-point Likert items cannot have value more than 6. The fact that there was no issue while verifying data accuracy was due to the precautionary steps taken during the preparation of online questionnaire, example, the required information was collected after setting "compulsory" as qualification in answering the next or following question and submitting the survey.

## **2. Reliability and Validity**

According to Babbie and Roberts (2018) reliability is the quality of a particular technique which yields same result every time it is repeated to the same object. For example, a reliable weighing machine provides accurate weight consistently when weighted again and again. In quantitative research, the reliability of the data collection instrument (questionnaire) can be established through different statistical techniques. One commonly based statistical value is Cronbach's alpha which determine the internal consistency of items. Taber (2018) found that this reliability value was referred to in 69 papers published in 4 leading science journals in 2015 alone as a measure of reliability. Before the start of the analysis of the present research data, the reliability of the variables was tested. While all the dimensions of the variables (defined and developed by the researcher and required validation which

are Leadership and GNH in Corporation) have attained the target alpha value of 0.7, a few dimensions (Resilience and Optimism) of Psychological Capital variable displayed alpha value less than the value of 0.7. In fact, that is understandable as the researcher chose Psychological Capital (PsyCap-12 item) Questionnaire instead of PsyCap-24 version considering respondents' time in completing the survey. However, PsyCap-12 is also an established and validated instrument used worldwide; the alteration and reliability improvement in the form of item deletion or so was not a good option. The alpha values for each variable are presented in the 'Appendix C: Descriptive Statistics', comparing statistics of actual data and the pre-test data. While the actual data was obtained from 511 employees of DHIL and its owned companies, pretest data was based on the responses collected from 252 academics of the colleges of Royal University of Bhutan.

In addition to the test of Reliability in terms of 'Internal Consistency', the 'Composite Reliability' assessment was also conducted as a prequalification prior to conducting Structural Equation Model analysis. Also, the convergent validity within the items of the construct and discriminant validity among the latent constructs were tested. The details are presented as a part of description when the analyses of measurement models are discussed later. As stated in the methodology section, for personality variable, the 15-item BFI-2SX questionnaire, the shortest form of Big-Five Inventory-2 (60 items) was used. The shortest version was chosen considering the questionnaire items of other variables; and most importantly considering the time and effort the research participants would require in completing the survey. According to Soto, & John (2017) who have shortened the BFI-2 (60 items) to BFI-2S (30 items) and BFI-2X-S (15 items), in terms of reliability and validity of the questionnaires, "at the level of the Big Five domains, analyses of multiple indicators converge in showing that the BFI-2-S retains about 90%, and the BFI-2-XS about 80%, of the BFI-2 domain scales". This only indicates that using BFI-2XS is a little compromise on reliability and validity. As expected, the test of internal consistency ascertained that Cronbach's alpha value of the composite personality variable data was 0.528. However, no personality items were deleted as the questionnaire was already tested, validated and is being widely used.

### 3. Normality Statistics

Before going ahead with the actual analysis, normality assessment is one important pre-requisite task, especially if the analysis of the data involves parametric testing. It is important in deciding the measures of tendency and the normal distribution. However, some researchers such as Ghasemi, & Zahediasl (2012) express that violation of normality in large samples should not be a major issue as they tend to have normal distribution irrespective of the shape of the data. There are numerous methods of ascertaining the normality of the data; could be either through numerical methods such as Shapiro–Wilk test, Kolmogorov–Smirnov test, skewness, kurtosis, mean with standard error, or visual methods through histogram, stem-and-leaf plot, box plot, P-P (Probability-Probability) Plot, and Q-Q (Quantile-Quantile) plot. However, not every test could be a perfect fit. Hence, the choice of normality test may be influenced by the sample size as well. Normally, for a small sample size of  $<50$ , and the medium size of  $50 \leq n < 300$  the z-test with the z value of  $\pm 1.96$  and  $\pm 3.29$  determine the normality respectively. The z score is obtained by dividing the skewness or kurtosis values by their standard error. As far as the data in the hand are concerned, the normality assessment values are presented in the form of mean, skewness, kurtosis, and standard error values. Although, a little negatively skewed, the data seem to be within the range of normal distribution. This is determined based on the absolute values of Skewness and kurtosis. Refer appendix C: Descriptive Statistics. According to Mishra et al. (2019), “either an absolute skewness value  $\leq 2$  or an absolute kurtosis (excess)  $\leq 4$  may be used as reference values for determining considerable normality” for sample size  $>300$ .

#### Statistical Tools for data Analysis

Structural Equation Model is the main method involving regression and covariance analysis. The other statistical techniques used are analysis of variance (One-way ANOVA), t-test and descriptive statistics such as mean and standard deviation. One way ANOVA and t-test are used in comparing variable means by demographic profile such as position level, leadership level, parent organization or sex.

### **Chapter Summary**

In this chapter, the research paradigm, methods, and methodology are discussed. The topics covered include population and sampling, data collection process, instruments used, data management and statistical analysis tools involved. The research aligns with the quantitative method. Although the interviews were conducted, the result was based on the quantitative data collected online through survey questionnaire; interview data were used as additional information. For the selection of samples, proportionate stratified random sampling was used. Structural Equation Modeling (SEM) was the main method for analyzing the relation among the variables of the study; SEM was based on the SPSS AMOS software. The conceptual framework was finalized with Leadership positioned as the predictor while employee performance was placed as the outcome variable. Within this equation, GNH in Corporation and Psychological Capital were placed as mediators. The statistical tools used in this research include regression and covariance [in SEM], analysis of variance, t-test, and descriptive statistics such as mean and standard deviation. Prior to the analysis of the result, reliability, validity, and normality of the data are assessed.



## CHAPTER IV

### RESULT & ANALYSIS

#### Content Outline

This chapter presents the details of data analyses and the results. The response rate and demographic information of the research participants are presented in the form of descriptive statistics such as frequency (count) and percentage. The results of other variables namely Leadership, GNH in Corporation, Employee Psychological Capital and Performance are also initially conveyed in the form of 'means' and 'standard deviation'. However, the results of hypothesis (after testing relationships among variables) are presented as the output generated through Structural Equation Model (SEM) analysis. In addition to these results from employee survey data, the interpretations of interviews are also elucidated under 'deconstruction of interview data'. While the SEM analysis is the basis for the 'acceptance' or 'reject (fail to accept)' hypotheses, the interpretation of qualitative interview data only supports the statistical findings.

#### Response Rate and Demographic Profile

##### 1. Response Rate

The number of respondents identified for this cross-sectional study was 511 and the response rate stands at 100 percent. It was found that the average time taken by participants to complete the survey was 36 minutes. The number of employee responses from BPCL was highest, while the least were from the DHI as per the pre-calculation. This response rate was based on the sample size determined using a-priori model which had 510 parameters to be estimated. However, after the re-specification of the model based on model-data fit analysis, the finalized model had a total of 70 distinctive parameters for estimation. The re-specified model is presented later under Structural Equation Model. The details of sample proportionality and response rate is depicted in the following table:

**Table 4 Response Rate**

Corporation	Staff Strength	Adjusted Sample Size	Actual Response	Response Rate
1. DHIL	116	10	10	100%
2. DGPCCL	1623	143	143	100%
3. BPCL	2350	207	207	100%
4. BTL	563	50	50	100%
5. NRDCCL	482	43	43	100%
6. Drukair Corp Ltd	403	36	36	100%
7. CDCL	245	22	22	100%
<b>Total Employees</b>	<b>5782</b>	<b>511</b>	<b>511</b>	<b>100%</b>

## 2. Respondents' Demographic Profile

The total response was a composite of male majority amounting almost 65% while the representation from female and 'other' were 35% and .20% respectively. In terms of the position level, with 160 responses (31.3%) the Supervisory category tops the participation followed by Managerial and Operational level groups at 154 (30.1%) and 28.2%. And there were 37 (7.2%) participants from General Service Category, while only 16 (3.1%) responses were from the Executive group. The information on position wise representation is presented in the following table:

**Table 5 The overall respondents' profile: Sex and Position level**

Variable	Category	Count	Percentage
Sex	Male	331	64.8%
	Female	179	35.0%
	Other	1	0.2%
Position Level	Executive Level	16	3.1%
	Managerial Level	154	30.1%
	Supervisory Level	160	31.3%
	Operational Level	144	28.2%
	General Service Category (GSC) Level	37	7.2%

As far as the sex ratio is concerned, more than half of the responses were male in all companies except the DHI company. For the DHI, 50% were females while 40 percent male. And there is also indication that a few would like to classify under ‘Other’ category. Considering the position wise profile, only DGPC, BPCL and BTL have representation from executive level. It is also very important to clarify here that, Executive group does not include Directors and CEO as respondents, as they are always on contract in DHI Position classification system. While the responses of all the companies are concentrated within managerial, Supervisory and Operational, the DHIL has representation from only Supervisory, Operational and GSC categories. This distribution may be because of the less samples collected from the DHIL. The process of random selection was followed for all companies though. The detailed information is summarized in the following table:

**Table 6 Respondent’s demography by Corporation**

		Corporation						
		DHIL	DGPCL	BPCL	BTL	NRDCL	DrukAir	CDCL
<b>Sex (%)</b>	Male	40.0	65.7	63.3	70.0	69.8	52.8	81.8
	Female	50.0	34.3	36.7	30.0	30.2	47.2	18.2
	Other	10.0	0.0	0.0	0.0	0.0	0.0	0.0
<b>Position Level (%)</b>	Executive	0.0	8.4	1.4	2.0	0.0	0.0	0.0
	Managerial	0.0	46.9	20.8	18.0	41.9	16.7	50.0
	Supervisory	20.0	31.5	40.6	10.0	27.9	11.1	36.4
	Operational	50.0	11.2	30.0	56.0	25.6	52.8	13.6
	GSC	30.0	2.1	7.2	14.0	4.7	19.4	0.0

## Leadership, GNH and Employee Performance

### 1. Leadership

#### 1.1 Leadership: Statistical Description

The Mean values of Leadership are compared among the DHI corporations. Going by the mean score of overall leadership, the DHI tops the list with  $4.302 \pm 0.597$  out of 5. It is followed by BTL and Druk Air Corporation with  $3.799 \pm 0.731$  and  $3.775 \pm 0.949$  respectively. The Leadership scores for DGPCL, BPCL, NRDCL and CDCL fall short of the average Leadership mean of corporations which stands at 3.648. In terms of the Leadership dimensions, 'Behavior' leads the score with mean value of 3.796 followed by 'Awareness', 'Character', and 'Skills' with 3.780, 3.654 and 3.361 respectively. Looking at the pattern of standard errors, the responses for DHIL seems to be consistent among the participants; the standard deviation is lowest of all corporations. On the other hand, the standard deviation of NRDCL is the highest implying comparatively more conflicting opinions of subordinates on their leadership. Refer Appendix D (Corporation wise Mean values of Leadership)

Certainly, there is differences on how subordinates of each company perceive leadership of their supervisor or leader based on the data. This holds true at least at face value. However, to determine if there are statistically significant differences of the perception, one-way 'Analysis of Variance (ANOVA)' test was conducted, and the result indicates that there is no significant difference in the mean values of leadership among the corporations. The p value of the test ( $0.091 > 0.05$ ) is not statistically significant. Even the mean values of leadership dimensions are not significantly different among the corporation. Hence, even though there are variations in actual arithmetic mean values, the perception of subordinates about leadership of their immediate supervisor does not vary by corporations. Since, the mean values do not differentiate significantly from each other, the post hoc test was not warranted.

In terms of the respondents' position, General Service Category (GSC) rated highest for their supervisor's leadership with score value of 3.88 compared to other categories. This is followed by operational level, where their mean value stands at 3.757. There is an indication that managerial level employees are least happy with their supervisors. However, these mean values do not actually determine

the overall picture. The one-way ANOVA test reveals that, no conclusion can be made that the perception on leadership [as the composite construct] depends on the employee position. The test shows non-significant difference with ANOVA p value of 0.79, which is more than 0.05. Hence, no specific groups(s) can be determined as statistically different from other, in terms of how they rate their supervisor leadership.

However, when the means of each leadership dimensions are compared, the leadership behavior of managerial level is found to be significantly low from Operational level and General Service Category employees with p values of .012 and .007 respectively. The mean values of other three leadership dimensions do not differ based on the employee position level. The result from the post hoc multiple comparisons of leadership dimensions using Tukey HSD is presented in this table:

**Table 7 Post hoc comparison of leadership dimensions by Respondent Position**

Multiple Comparisons							
Tukey HSD							
Dependent Variable	(I) Respondent Position Level	(J) Respondent Position Level	Mean Difference (I-J)	Std. Error	p	95% Confidence Interval	
						Lower Bound	Upper Bound
Leadership Behavior	Managerial Level	Executive Level	-.3379	.2562	.680	-1.039	.364
		Supervisory Level	-.1591	.1101	.599	-.461	.142
		Operational Level	-.3632*	.1131	.012	-.673	-.054
		GSC Level	-.6003*	.1786	.007	-1.089	-.111

\*. The mean difference is significant at the 0.05 level.

The perception of leadership is also compared based on the demographic information of sex of the respondents. The t-test test result shows lack of significant difference of perception based on sex category of employees. The t-test instead of ANOVA was opted to compare means of male and females only; responses under 'other' category was negligible. And, when the leadership scores are compared by leadership levels the Unit Heads, Section Heads, Division Heads and 'Other' have



almost equal mean values with 3.672, 3.675, 3.648 and 3.668 respectively. However, the mean score of 'Department Heads' realizes mere 3.579, which falls below the average mean of 3.648. The higher level of analysis using ANOVA was conducted to ascertain whether leadership values differ statistically based on the leadership level categories. The output indicates that the leadership, when compared either at composite or individual dimensions wise, no significant difference of scores could be confirmed among the different levels of leadership. The position wise mean values of leadership can be referred from the following table:

**Table 8 Position wise Perception of Leadership**

Position Level	Statistics	Leadership Dimension				leadership
		S	A	C	B	
Executive	Mean	3.390	3.719	3.708	3.928	<b>3.686</b>
	SD	0.386	0.698	0.693	0.580	0.510
Managerial	Mean	3.296	3.690	3.538	3.590	<b>3.529</b>
	SD	0.732	1.003	1.175	1.044	0.916
Supervisory	Mean	3.326	3.744	3.607	3.749	<b>3.607</b>
	SD	0.741	0.972	1.076	0.981	0.864
Operational	Mean	3.438	3.867	3.769	3.953	<b>3.757</b>
	SD	0.712	1.056	1.045	0.973	0.861
GSC	Mean	3.479	3.991	3.869	4.191	<b>3.882</b>
	SD	0.557	0.866	0.903	0.772	0.673
Total	Mean	3.361	3.780	3.654	3.796	<b>3.648</b>
	N	511	511	511	511	511
	SD	0.711	0.992	1.079	0.988	0.863

**Note:** S=Skills; A=Awareness; C=Character; B=Behaviour

## 1.2 Leadership Styles

Leadership styles are identified in various ways by different authors, of which the identification based on Ohio State University and Michigan University could be the perfect reference point. These studies try to measure leaders' orientation for people (Consideration/employee orientation) and leaders' concern for the profit or

tasks (Initiating Structure/production orientation). If put under this framework, the leadership of DHI Corporations intersect at ‘moderately high consideration’ and ‘moderately high initiating structure’ with mean scores of 6.7953 and 6.8721 (calculated out of 9) respectively. These values somehow fit into the fourth quadrant of leadership grid [Team Management] of Blake and Mouton (1964). Technically, the people orientation and task orientation intersect somewhere between ‘Middle of the road’ and ‘Team management’. Based on the intersection of leader’s orientation, the leadership/management styles are broadly categorized as: Impoverished Management (1,9); Middle-of-the-Road Management (5,5); Team Management (9,9); and Task/authority-obedience/produce or perish Management ((9,1).

### **1.3 Leadership Index**

As explained in the methodological discussion, the leadership index was constructed using Alkire-Foster method of Multi-dimensional Index. This method is very rational which can capture information from multidimensions for index calculation. This is widely used in poverty and wellbeing studies. Although, not sure about the prior leadership studies which used this method, researcher was convinced that it is equally applicable for Leadership studies. Thus, this method was identified and used to deduce leadership index. Basically, the dual cut-offs were assigned. The first cut-off for Leadership Awareness, Character and Behavior was set at 4, while for Leadership Skills, threshold was decided at 8. Hence, the first cut-off ( $z=4, 8$ ) was based on the scale used in measuring the indicators. The  $z=4$  aligns with the 6-point scale (0-5) items of the Awareness, Character, and Behavior dimensions; the rating of 4 directly means leaders exude indicators of these dimensions ‘Most Often’. For, Leadership Skill dimension, leaders were rated 1 to 10; and cut-off ( $z=8$ ) was set based on their Performance band which categorizes 8/10 as ‘excellent’. Thus, the threshold standard was set high so that more leadership improvement areas could be uncovered.

The second cut-off to determine the Leadership was based on the fulfilment of number of dimensions. Since Leadership is composite of four dimensions, the threshold was set at 2 ( $k=2$ ), meaning that, failing to satisfy at least two domains would disqualify to be considered meaningful leadership. The

information was generated based on these criteria and leadership gradient is represented in the following table which was used for calculating the index:

**Table 9 Leadership Category**

Leadership gradient	No. of unsatisfied domains	Frequency	Percent
Meaningful (48.73%)	0	166	32.5
	1	83	16.2
	2	54	10.6
Need improvement (51.27%)	3	69	13.5
	4	139	27.2
Total		511	100

The Leadership Index is calculated as follows:

1. The number of respondents who failed to rate and satisfy at least 2 domains=262

2. Total Participants=511

3. Headcount Ratio,  $H=262/511=0.5127$

4. Breadth/Intensity of non-fulfillment/non-satisfied domain threshold,  $A=$

5.  $(2/4*54)/262+(3/4*69)/262+(4/4*139)/262=0.2770$

6. Adjusted Headcount Ratio ( $H*A$ ) =  $0.5127*0.2770=0.142$

To convert, higher the value, the better leadership, The final Leadership Index is computed by subtracting the Adjusted Head count ratio from 1,

Thus, Leadership Index= $1-0.142=0.858$

## 2. GNH in Corporation

### 2.1 GNH in Corporation: Statistical Description

The following figure displays the scores in terms of arithmetic mean for each domain of GNH in Corporation. The corporate concern for culture tops the list followed by Community Vitality and Concern for Environment with mean values of 4.84 and 4.71 and 4.67. However, employees seem to be less impressed by training and education with score less than 4. The detailed information can be inferred from the following bar graph.

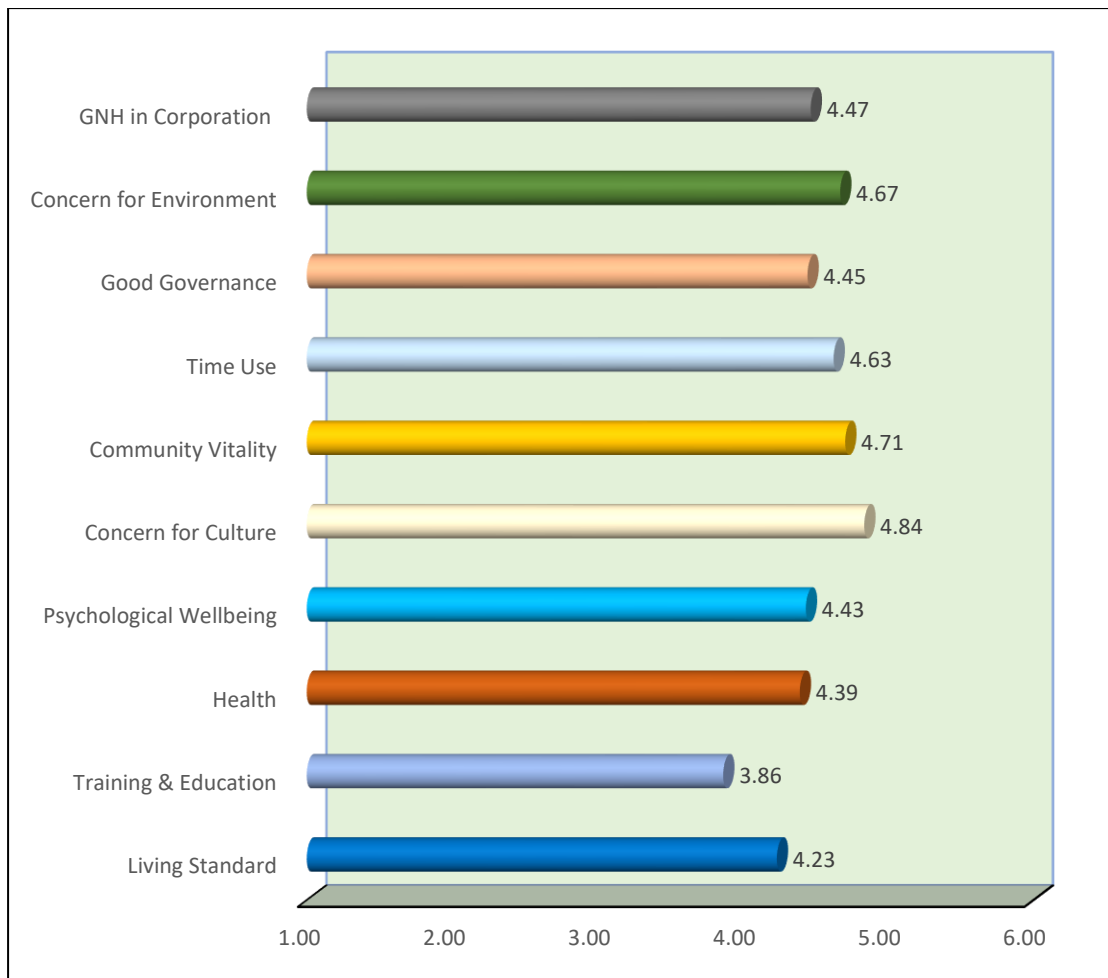

**Figure 2 Overall Mean values of GNH Domains**

The level of GNH in Corporation was also compared among the companies. The average mean stands at 4.5. At the face value, the aggregated mean score of GNH in Corporation for DHIL is the highest with 4.7 followed by DGPCL and DrukAir. The ratings of rest of the corporations, BPCL, BTL, NRDC and CDCL fall short of the average with just 4.4 each. The respondents were also asked separately “taking all things together, how happy would you say you are on the scale of 0 to 10?”. DHIL rated high on this happiness question as well, followed by DGPCL with 7.8 and 7.2 respectively. The comparative mean values are presented in the following table:

**Table 10 GNH in Corporation & Happiness Score by Corporation**

Corporation	Statistics	GNH in Corporation	* Happiness Score
DHIL	Mean	4.7	7.8
	SD	0.63	1.69
DGPCL	Mean	4.6	7.2
	SD	0.51	1.88
BPCL	Mean	4.4	6.9
	SD	0.56	2.06
BTL	Mean	4.4	7.1
	SD	0.61	2.13
NRDCL	Mean	4.4	7.0
	SD	0.61	2.13
DrukAir	Mean	4.5	7.0
	SD	0.62	2.08
CDCL	Mean	4.4	6.9
	SD	0.60	1.86
Total	Mean	4.5	7.1
	SD	0.56	2.01

**Note:** \* The happiness score is the average scores of data based on the question “*taking all things together, how happy would you say you are on the scale of 0 to 10?*”.

Despite the differences in mean values of both the GNH in Corporation and happiness feeling, their mean values do not differ statistically significantly. The p values of one-way ANOVA tests for GNH in corporation stands at 0.104, while for happiness feeling, p value is 0.766. The psychological feeling of happiness or life satisfaction also does not differ significantly by sex of respondents either. The GNH in Corporation and the happiness rating [ scores of “*taking all things together, how happy would you say you are on the scale of 0 to 10?*”] were also compared among the different position levels of employees. Although not statistically significant difference is observed based on position level, ‘Managerial Positions’ employees rated lowest with the mean value of 4.41, while the Executive level employees rated highest at 4.62. And the psychological wellbeing, time use, and good



governance are the three dimensions managerial level rated lowest. In the living standard domain, employees under General Service Category (GSC) and operational level indicated low level of agreement. And, in terms of happiness rating, Supervisory and managerial groups are at the bottoms with average value of mere 7.02 and 7.03 respectively. Refer the following table for detailed information.

**Table 11 GNH and Happiness Scores by Position Level**

GNH/Dimensions	Position Level of employees				GSC
	Executive	Managerial	Supervisory	Operational	
1. Living Standard	4.45	4.19	4.36	4.15	4.11
2. Training and Education	4.38	3.92	3.82	3.79	3.91
3. Health	4.74	4.38	4.44	4.33	4.36
4. Psychological Wellbeing	4.42	4.37	4.47	4.45	4.51
5. Concern for Culture	4.7	4.7	4.85	4.91	5.13
6. Community Vitality	4.58	4.61	4.68	4.8	4.89
7. Time Use	4.72	4.58	4.59	4.69	4.7
8. Good Governance	4.55	4.32	4.44	4.53	4.64
9. Concern for Environment	5.02	4.59	4.68	4.65	4.91
GNH in Corporation	<b>4.62</b>	<b>4.41</b>	<b>4.48</b>	<b>4.48</b>	<b>4.57</b>
Happiness Score	<b>6.75</b>	<b>7.03</b>	<b>7.02</b>	<b>7.14</b>	<b>7.19</b>

It is interesting to note that, executive level employees rated comparatively higher in ‘training and education’ domain with mean score of 4.38. This is followed by managerial, supervisory, and operational level in decreasing pattern with mean values of 3.92, 3.82 and 3.79 respectively. However, the perception of GSC level employees on training and education opportunity is comparable to Managerial level scoring 3.91. As an additional information on this domain of GNH in Corporation, the statistics of short-term training and long-term studies are presented in the following table.

**Table 12 Short term Training and long-term Studies availed**

Short term Training/Development			Long-term Study availed		
Number of days	Count	Percent	Programme	Count	Percent
Never	368	72.0	Not availed	429	84
1-10 days	123	24.1	Diploma	10	2.0
11-20 days	12	2.3	Bachelor Degree	13	2.5
21-29 days	2	.4	Master's Degree	44	8.6
1 to 6 months	6	1.2	PhD	15	2.9
Total	511	100.0	Total	511	100

The mean values of GNH in Corporation items are presented under four pillars of GNH. In the actual framework, GNH is defined fundamentally with its four pillars. They are Sustainable and equitable social and economic development, preservation and promotion of culture, Good Governance and Conservation of environment. The Sustainable and Equitable Social and Economic Development pillar is composed of three domains of Living Standard, Education and Health; the Preservation of Culture as second pillar is made up of psychological wellbeing, community vitality, time use, cultural diversity and resilience domains; and two other pillars are Conservation of environment and Good Governance.

Besides the Likert items, respondents were asked additional questions related to incidences of sexual harassment in the workplace and their health status. Although more than 80 percent of the participants have never encountered any sexual harassment, the workplace in the corporations cannot be considered totally safe; almost 17 percent of employees indicated that they have experienced unpleasant incidences. While 11.7% expressed that they face sexual abuse 'rarely', the proportion of others who experience the incidence 'sometime' and 'often' stand at 4.7% and 0.4% respectively. The sexual harassment includes "making unwelcome sexual advance or an unwelcome request for sexual favours to the other person; or engaging in any other unwelcome conduct of sexual nature in relation to the other person" ("Labour and Employment Act of Bhutan," 2007). And the conduct of sexual nature is defined in the Act as "subjecting a person to any act of physical intimacy; making any

oral or written remark or statement with sexual connotations to a person or about a person in his or her presence; or making any gesture, action or comment of a sexual nature in a person's presence". The following figure portrays the occurrence of sexual harassment in corporations.

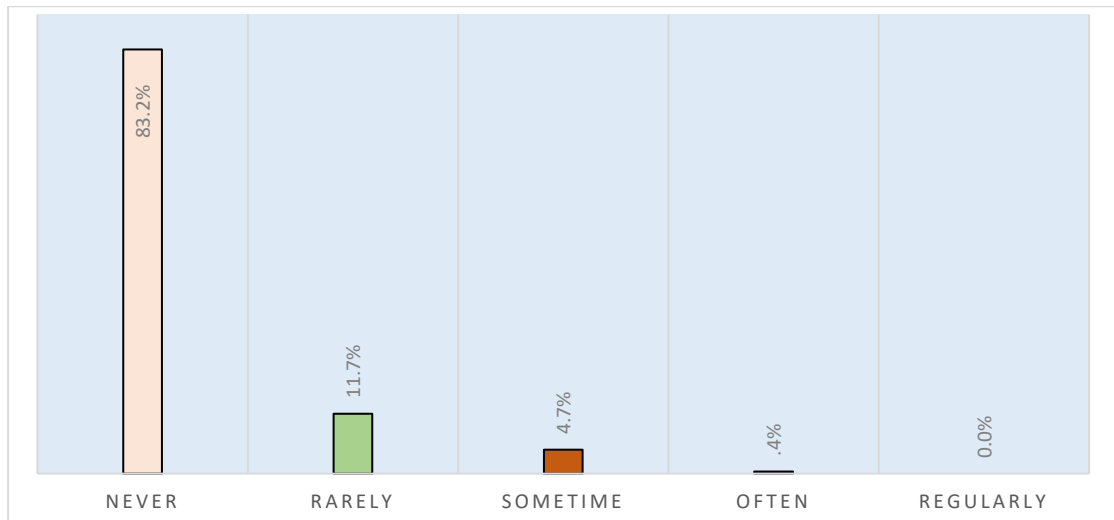

**Figure 3 Incidences of Sexual harassment**

When employees were asked whether they suffered any illness or injury in the recent past, at least 19.4% of the total respondents claimed that they were either ill or injured in the last one month. Among those injured, at least five have been admitted in hospital for overnight stay, 48 availed OPD services while 43 did not bother to visit any Centre or hospital for the health service. And when it comes to sleeping hours in a 24-hour cycle, 74.4% of the participants sleep more than seven hours (70.8% sleeps 7-8 hours, 2.9% 9-10 hours, and a little less than 1% sleeps more than 10 hours). However, more than one-quarter indicated that the time spent on sleeping is less than 6 hours. According to Centers for Disease Control and Prevention (n.d), an adult, who are more than 18 years of age are recommended to sleep seven or more hours per day. The sleeping hours of employees of DHI and its owned corporations are presented in the following figure.

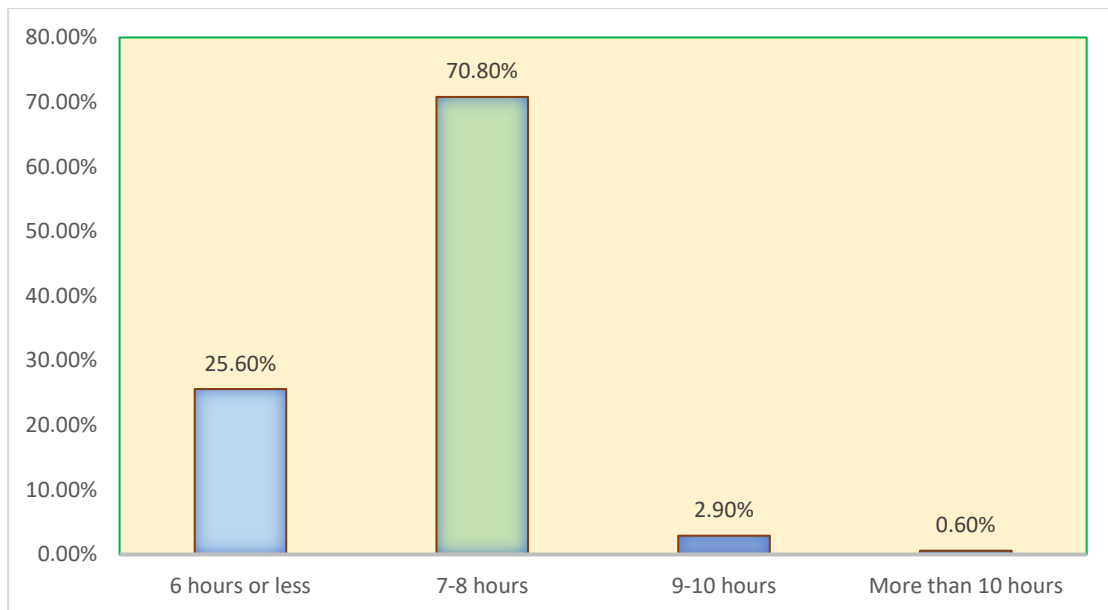

**Figure 4 Sleeping hours**

## 2.2 Corporate Values

The respondents were asked to rate seven identified organizational corporate values. In respect to 'Integrity' and 'Responsibility', only a few, less than five percent feel either 'fair' or 'poor'. Similarly, almost 95% of respondents agree on 'teamwork'. Among the corporate values, only 'Equity', 'Transparency' and 'Accountability' could not make at least 90% of the respondents agree. More than 10% indicated that equity, transparency, and accountability could be improved. The details are given in the table:

**Table 13 Overall Corporate Values**

Corporate Values	Poor	Fair	Good	Very Good	Excellent
Integrity	2.0%	2.5%	23.9%	46.0%	25.6%
Equity	4.9%	11.5%	34.8%	39.5%	9.2%
Responsibility	1.6%	3.3%	30.1%	41.5%	23.5%
Transparency	5.7%	13.5%	34.2%	33.3%	13.3%
Accountability	3.7%	9.0%	32.7%	37.8%	16.8%
Teamwork	1.4%	4.1%	29.2%	41.9%	23.5%
Health & Safety	1.2%	6.8%	29.2%	36.0%	26.8%

The rating labelled Poor, Fair, Good, Very Good and Excellent are converted into numeric through 5-point Likert scale by assigning 1 for Poor and 5 for Excellent for calculating arithmetic mean values. According to the statistics, DHIL seem to fare well in almost all the corporate values; However, CDCL respondents agree more in terms of 'Health and safety' with mean value of 4.09. The BPCL comparatively lacks 'integrity', 'responsibility', 'transparency', and 'accountability'. NRDCCL scores lowest in 'teamwork' and 'Health and Safety' fronts. Refer the following table for more information.

**Table 14 Corporation wise mean scores of corporate values**

*Corpn	Statistics	**CV1	CV2	CV3	CV4	CV5	CV6	CV7
DHIL	Mean	4.40	3.90	4.10	3.90	3.80	4.10	4.00
	SD	1.350	1.287	0.994	1.287	1.229	1.101	1.054
DGPCCL	Mean	3.97	3.41	3.91	3.27	3.62	3.85	3.94
	SD	.826	.890	.847	.943	.879	.906	.913
BPCL	Mean	3.78	3.24	3.69	3.20	3.42	3.77	3.77
	SD	.824	.923	.826	1.049	.981	.803	.936
BTL	Mean	3.96	3.40	3.90	3.44	3.62	3.86	3.64
	SD	.9889	1.088	1.074	1.072	1.048	0.948	0.921
NRDCCL	Mean	3.95	3.44	3.77	3.70	3.58	3.72	3.42
	SD	.8985	1.140	1.043	1.206	1.159	1.161	1.052
DrukAir	Mean	4.03	3.47	4.03	3.61	3.75	3.92	3.92
	SD	.9098	1.134	0.845	1.050	1.052	0.841	0.996
CDCL	Mean	4.14	3.68	3.95	3.73	3.64	3.95	4.09
	SD	.9409	.716	.722	.985	1.136	.722	.868
Total	Mean	3.91	3.37	3.82	3.35	3.55	3.82	3.80
	N	511	511	511	511	511	511	511
	SD	.875	.971	.883	1.052	.995	.885	.950

**Note:** \*Corpn=Corporation

\*\*CV1: Integrity; CV2: Equity; CV3: Responsibility; CV4: Transparency;

CV5: Accountability; CV6: Teamwork; CV7: Health & Safety



**Table 15 One-way ANOVA result for Health & Safety among Corporations**

ANOVA					
Health & Safety					
	Sum of Squares	df	Mean Square	F	p
Between Groups	13.115	6	2.186	2.463	.023
Within Groups	447.315	504	.888		
Total	460.431	510			

The one-way ANOVA test was conducted for each of the corporate values to ascertain whether they differ significantly from organization to organization. Only the score of 'Health and Safety' was observed to be significant among the corporations at  $p < 0.05$  level [(F (6,504) = 2.463,  $p = 0.023$ ]. Even though statistically significant difference was noted, the actual difference in mean scores between the groups was very small. The effect size calculated using eta squared ['Sum of squares between-groups' divided by 'Total sum of squares' =  $13.115/447.315$ ] is only 0.0293.

**Table 16 post-hoc test summary for 'Health & Safety'**

Corporation		Mean Difference (I-J)	Std. Error	p	95% Confidence Interval	
I	J				Lower Bound	Upper Bound
NRDCL	DHIL	-.5814	.3307	.577	-1.561	.398
	DGPCL	-.5185*	.1638	.027	-1.004	-.033
	BPCL	-.3543	.1579	.274	-.822	.113
	BTL	-.2214	.1959	.919	-.801	.359
	DrukAir	-.4981	.2128	.227	-1.128	.132
	CDCL	-.6723	.2469	.095	-1.403	.059

Post-hoc comparisons using the Tukey HSD test revealed that the mean score for NRDCL (3.42) was significantly different from DGPCL (3.94). The other Corporations do not differ significantly from each other.

### 2.3 GNH in Corporation Index

Before computing the GNH index, sufficiency gradient was worked on so that the extent of sufficiency of indicators of each domain could be understood. The gradient is based on four sufficiency cut-offs. The respondent is identified as ‘Under sufficiency’, ‘Somewhat sufficient’, ‘Sufficient’, or ‘Deeply Sufficient’ depending on whether he/she enjoys sufficiency in less than 58.25%, 58.3% to 74.8%, 75% to 91.5%, or more than 91.6% of indicators within each domain respectively. The questionnaire used 6-point Likert scale to rate the items (1=Strongly Disagree, 2=Disagree, 3=Somewhat Disagree, 4=Somewhat Agree, 5=Agree, 6=Strongly Agree). This gradation of sufficiency would indicate which domain needs to focus more for the policy level decision making.

**Table 17 Domain wise Sufficiency gradient of indicator scores**

GNH in Corporation: Domains	Sufficiency Gradient			
	Under Sufficiency	Somewhat Sufficient	Sufficient	Deeply Sufficient
1. Living Standard	20.5%	35.2%	38.7%	5.5%
2. Education & Training	33.1%	35.4%	29.2%	2.3%
3. Health	13.7%	37.6%	43.2%	5.5%
4. Psychological Wellbeing	6.3%	37.8%	50.7%	5.3%
5. Concern for Culture	3.3%	23.3%	60.9%	12.5%
6. Community Vitality	6.3%	26.0%	56.6%	11.2%
7. Time Use	6.7%	24.1%	57.5%	11.7%
8. Good Governance	11.5%	33.1%	48.3%	7.0%
9. Concern for Environment	6.1%	25.8%	53.2%	14.9%

To compute GNH in Corporation Index, Alkire-Foster (AF) method was used. This technology is flexible and applied for multiple dimensions, designed initially for measuring multi-dimensional poverty. The index is based on dual cutoffs. The first is the ‘identification cutoff’ where the poor/deprived would be identified from non-poor/not deprived at indicator or domain level. The second ‘Aggregation cutoff’ concerns the intensity, as how much poverty/deprivation is determined. The

GNH in Corporation Variable is composed of 44 indicators which are ultimately grouped into nine domains; and all domains are equally weighted. Since all the indicators are survey items, and each domain is given equal weight, the first sufficiency threshold ( $z$ ) was based on the average mean values of indicators forming a domain. Hence, the mean value of 4.5 is set as an initial cut-off point to differentiate the sufficient from non-sufficient values based on the indicator ratings forming domains. This cut off is set based on the Likert Scale label, where “4=Somewhat agree, 5=Agree, and 6=Strongly Agree” to each statement. The cut-off was set at 4.5 as it falls between ‘Somewhat agree’ and ‘agree’. So, those who scores less than 4.5 in average indicators of the domain is interpreted as categorically lacking ‘sufficiency’ in that domain. The second cut-off is the number of domains failing to fulfill the sufficiency cut-off. This ‘happiness threshold’ ( $k$ ) was set at 6, meaning that if respondents fail to score 4.5 in at least 6 domains, they are defined “Unhappy”. So, to be identified as happy, participants should have sufficiency in more than 66.67% (6/9) of the domains. Thus, based on the second cut-off, following result was obtained:

**Table 18 Happiness gradient based on number of sufficiency domains**

Happy/Unhappy Proportion	Happiness Gradient	No of domains lacking sufficiency	Frequency	Percent
Happy (40.3%)	Extremely Happy	0	10	2.00%
		1	22	4.30%
	Happy	2	31	6.10%
		3	41	8.00%
		Happy Somewhat	4	43
5	59		11.50%	
Unhappy (59.7%)	Somewhat Unhappy	6	71	13.90%
		7	77	15.10%
	Unhappy	8	79	15.50%
		Extremely Unhappy	9	78
	Total			511

Based on the information from the table:

- Head Count Ratio (Number of unhappy respondents)

$$H = 305/511 = 0.596869.$$

- Breadth/Intensity of unhappy

$$A = (6/9*71)/305 + (7/9*77)/305 + (8/9*79)/305 + (9/9*78)/305 = 0.837523$$

**Adjusted Head Count Ratio** (when the first cut-off, sufficiency threshold was set at 4.5 or the sufficiency in 75% of the indicators)

$$H*A = 0.596869 * 0.83752 = 0.499891$$

$$\text{GNH in Corporation Index} = 1 - 0.499891 = 0.500109$$

### 3. Employee Performance

The Self-reported questionnaire consisted of 18 items, which are subdivided into three dimensions of 'Task Performance', 'Contextual Performance' and 'Counterproductive Work Behaviour'. When it comes to Task Performance, DHIL, Drukair and NRDCL seems to be comparatively better with mean values of 4.8, 4.52 and 4.48 respectively. The mean values of CDCL, DGPCL and BTL for this dimension of performance fall short of the average mean of 4.34. However, BTL, DHIL and NRDCL scores high on Contextual Performance. There is indication that employees of BTL, Drukair and CDCL exude the counterproductive work behaviour relatively more than other corporations. These are only based on mean comparisons at face value though; and whether the means differ significantly among or between corporation is analyzed and presented later. The following table provides the descriptive statistics of performance by corporations.

**Table 19 Corporation wise Mean values of employee performance**

Corporation	Statistics	<sup>1</sup> TP	<sup>2</sup> CP	<sup>3</sup> CWB	<sup>4</sup> Overall SRP
DHIL	Mean	4.800	4.325	.780	<b>4.448</b>
	SD	.2667	.3545	.9818	.3543
DGPCL	Mean	4.222	3.855	.927	<b>4.050</b>
	SD	.5526	.6418	.7921	.4213
BPCL	Mean	4.365	3.816	.902	<b>4.093</b>
	SD	.5805	.8004	.7924	.5152
BTL	Mean	4.328	4.013	1.124	<b>4.072</b>
	SD	.5908	.7514	.8220	.4501
NRDCL	Mean	4.488	4.041	.786	<b>4.248</b>
	SD	.5526	.7975	.7945	.4943
DrukAir	Mean	4.522	3.944	1.022	<b>4.148</b>
	SD	.4998	.7886	.8563	.4815
CDCL	Mean	4.173	3.881	1.118	<b>3.978</b>
	SD	.7491	.7544	.8894	.5996
Total	Mean	4.343	3.887	.937	<b>4.098</b>
	N	511	511	511	511
	SD	.5788	.7471	.8083	.4847

**Note:** 1. TP=Task Performance;  
 2. CP=Contextual Performance;  
 3. CWB=Counterproductive Work Behaviour;  
 4. Overall SRP=Overall Self-reported Performance

To determine if there are statistically significant differences in mean values of the performance by corporations, one-way ANOVA test was conducted. The test reveals statistically significant differences at the  $p < .05$  level in 'Task Performance' and 'Overall Performance' among the corporations [ $F(6, 504) = 3.58, p = 0.002$ ; and  $F(6, 504) = 2.13, p = 0.049$ ]. The effect size calculated using eta squared (sum of squares between-groups divided by total sum of squares) are 0.040 and 0.024



respectively, indicating the difference in mean scores between the groups are very small.

**Table 20 ANOVA Test result for Performance by Corporations**

		Sum of Squares	df	Mean Square	F	p
Task Performance	Between Groups	6.985	6	1.164	3.58	0.002
	Within Groups	163.889	504	0.325		
	Total	170.874	510			
Contextual Performance	Between Groups	5.02	6	0.837	1.508	0.173
	Within Groups	279.672	504	0.555		
	Total	284.692	510			
Counterproductive Behaviour	Between Groups	4.219	6	0.703	1.077	0.375
	Within Groups	329.006	504	0.653		
	Total	333.226	510			
Overall Performance	Between Groups	2.964	6	0.494	2.13	0.049
	Within Groups	116.867	504	0.232		
	Total	119.831	510			

Even though the one-way ANOVA result shows significance for ‘Task Performance’ and ‘Overall Performance’, the Post-hoc comparisons using Tukey HSD test reveals that only mean score of the Task performance of DHIL (M=4.8, SD=0.2667) is significantly different from DGPCL (M=4.2, SD=0.5526). The mean scores of other do not differ among/within themselves or with DHIL or DGPCL. The post-hoc analysis however could not determine between-groups difference for overall performance; the ANOVA result could be simply a false positive. The test result is given in the following table.

**Table 21 post-hoc test summary of Performance by Corporations**

Dependent Variable	Corp-I	Corp-J	Mean Difference (I-J)	Std. Error	p	95% Confidence Interval	
						Lower Bound	Upper Bound
Task Performance	DHIL	DGPCL	.5776*	0.1865	0.034	0.025	1.13
		BPCL	0.4348	0.1846	0.22	-0.112	0.981
		BTL	0.472	0.1975	0.205	-0.113	1.057
		NRDCL	0.3116	0.2002	0.71	-0.281	0.904
		DrukAir	0.2778	0.2038	0.821	-0.326	0.881
		CDCL	0.6273	0.2175	0.062	-0.017	1.271

The one-way ANOVA test was also conducted to verify if the employee performance differs based on position levels. The result indicates the statistical significance in the task and contextual performances at  $p < .05$  [ $F(4, 506) = 5.598$ ,  $p = 0.000$ ; and  $F(4, 506) = 2.77$ ,  $p = 0.026$ ] respectively. When the further analysis of post-hoc comparisons [using Tukey HSD] was performed, the task performances of Operational and General Service Category employees are found to be statistically better than those of managerial level employees. However, the post-hoc analysis cannot determine the statistical difference in terms of contextual performance based on employee position level. Thus, it is concluded that while the contextual performance and counterproductive work behavior are not significantly different among the different levels of position, the task performance of Operational and General Service Category staff is distinctively better than those of managerial level employees.

**Table 22 post-hoc test summary of Performance by Position Level**

Dependent Variable	<sup>1</sup> Level-I	<sup>2</sup> Level-J	Mean Difference (I-J)	Std. Error	p	95% Confidence Interval	
						Lower Bound	Upper Bound
						Task Performance	ML
SL	-.1527	.0642	.123	-.328	.023		
OL	-.2509*	.0659	.001	-.431	-.070		
GSCL	-.3957*	.1041	.002	-.681	-.111		

**Note:** 1. Level-I, ML=Managerial Level

2. Level-J, EL=Executive Level; SL=Supervisory Level; OL=Operational level;

GSCL=General Service Category Level

The independent samples t-test ascertained that the employee performance scores do not differ significantly based on the sex of employees; the two-tailed significance values for task performance, contextual performance and counterproductive work behavior were .976, .172 and .377 respectively.

Employees were also asked to provide the actual performance they achieved in the previous annual performance rating. The performance category was based on the band followed in DHIL and its Corporations. The performance is categorized as per the Individual Work Performance scores as follows: Unacceptable (<49.9); Below Satisfactory (50-64.9); Satisfactory (65-79.9); Commendable (80-89.9); and Outstanding (90-100). It is encouraging to note that majority of employees' performances fall under Commendable (55.8%) followed by Outstanding (33.5%) category. The portion of employees whose performance does not meet Satisfactory level is very countable which is less than 2.5%.

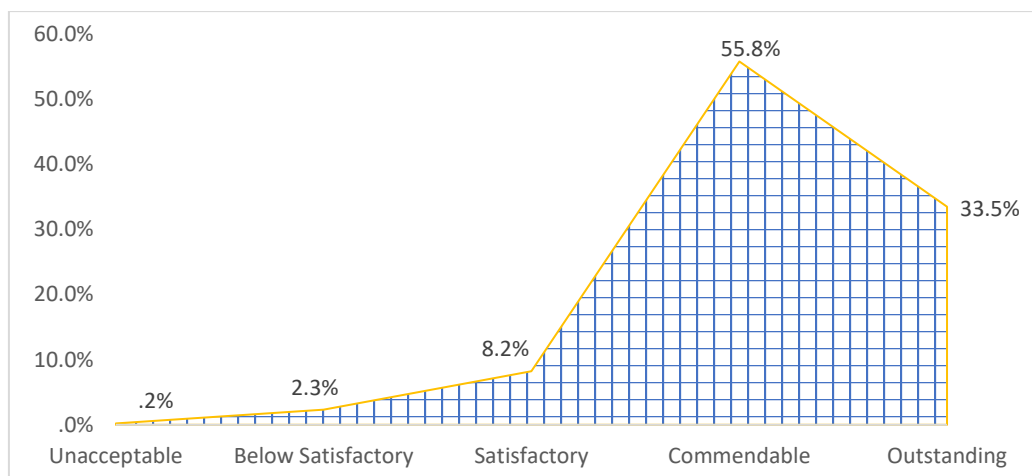

**Figure 5 Proportion of employees in each performance band**

To get the clear picture of actual employee performance in the previous year (2021), the performance scores were compared among the seven corporations. As in the case of self-reported performance statements, the actual performance scores of DHI are exemplary with 90 percent of the participants achieving ‘excellent (90-100)’ and the 10 percent ‘commendable (80-90)’. An employee is eligible for two-month salary bonus if one obtains at least ‘commendable’. And more than 80 percent of employees of other DHI owned corporations also scored at least ‘commendable’ except CDCL implying that only around 59 percent of CDCL respondents met bonus threshold.

**Table 23 Corporation wise actual performance scores**

Corporation	Actual Performance rating of the previous year (2021)				
	<49.9	50 to 64.9	65 to 79.9	80 to 89.9	90 to 100
DHIL	0.0%	0.0%	0.0%	10.0%	90.0%
DGPCL	0.0%	2.1%	4.9%	51.0%	42.0%
BPCL	.5%	2.4%	6.8%	67.1%	23.2%
BTL	0.0%	0.0%	10.0%	52.0%	38.0%
NRDCL	0.0%	2.3%	14.0%	53.5%	30.2%
DrukAir	0.0%	0.0%	11.1%	41.7%	47.2%
CDCL	0.0%	13.6%	27.3%	36.4%	22.7%

#### 4. Psychological Capital and Personality

##### 4.1 Psychological Capital: Statistical Descriptions

The overall Mean score of Psychological Capital (PsyCap) for DHI and its owned companies stand at 4.96. The respondents who identified to be at executive level seems to lead the figure with 5.1. There is no huge gap in mean scores by position level though. The ANOVA test confirms that there are no significant mean differences either in terms of position level or based on corporations. However, the t-test revealed that the level of Psychological Capital for male group is statistically higher than the females with  $p(0.02) > .005$ . When the mean scores of each dimension of Psychological Capital were compared by Sex, only the mean values of Efficacy and Hope were observed to be significantly lower for females with  $p$  values of .000 and 0.04 respectively.

**Table 24 Descriptive statistics for Psychological Capital by sex**

Psychological Capital/ Dimensions	Respondent Sex	Mean	SD	Std. Error Mean
Efficacy	Male	5.203	.6495	.0357
	Female	4.980	.6449	.0482
Hope	Male	5.054	.5390	.0296
	Female	4.878	.7122	.0532
Resilience	Male	4.781	.6380	.0351
	Female	4.700	.7412	.0554
Optimism	Male	5.026	.7355	.0404
	Female	5.073	.7737	.0578
Psychological Capital	Male	5.016	.4669	.0257
	Female	4.908	.5567	.0416

The following table represents the t-test result of mean differences of Psychological Capital and its domains by sex. Although the result of Levene's Test for Equality of Variances is not presented in the result table, the two-tailed significance value of efficacy of 0.000 is based on the equal variance assumed, as the significance value of Levene's test shows  $p(.0779) > .05$ . However, the two-tailed significance value of 0.04 of Hope is identified based on the 'equal variance not



assumed' because of failing to achieve levene's test of equality of variance assumed. The t-test result for psychological Capital by sex is presented in the following table.

**Table 25 The t-test result of Psychological Capital Means by Sex**

PsyCap/Domains	t-test for Equality of Means				
	Sig. (2-tailed)	Mean Difference	Std. Error Difference	95% Confidence Interval of the Difference	
				Lower	Upper
Efficacy	.000	.2239	.0601	.1058	.3420
	.000	.2239	.0600	.1060	.3419
Hope	.002	.1751	.0562	.0648	.2855
	.004	.1751	.0609	.0552	.2950
Resilience	.196	.0813	.0627	-.0419	.2045
	.216	.0813	.0656	-.0477	.2103
Optimism	.500	-.0469	.0695	-.1835	.0896
	.506	-.0469	.0706	-.1857	.0918
PsyCap	.020	.1083	.0464	.0172	.1995
	.027	.1083	.0489	.0122	.2045

The details of Psychological Capital by Position level are presented in the following figure. In terms of the 'Efficacy' the Executive scores highest with value of 5.5 followed by Managerial group with mean score of 5.2. Supervisory and Operation employees rated 5.1. In terms of 'Hope' Executive and Supervisory levels score 5.1 each. Among the four dimensions, the 'Resiliency' is being rated lowest by every position level.

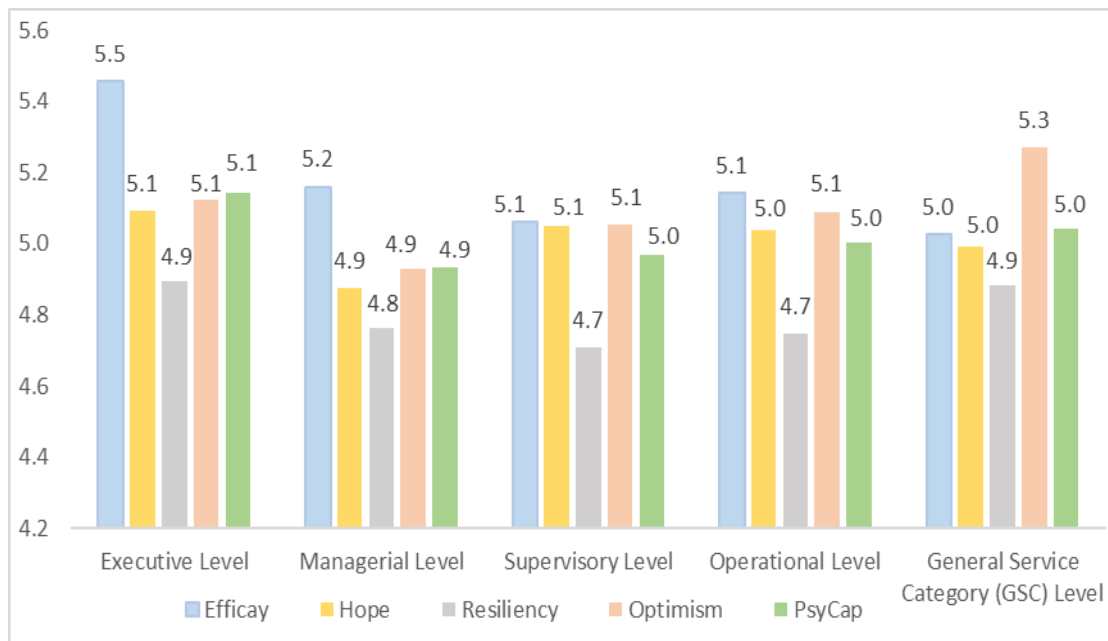
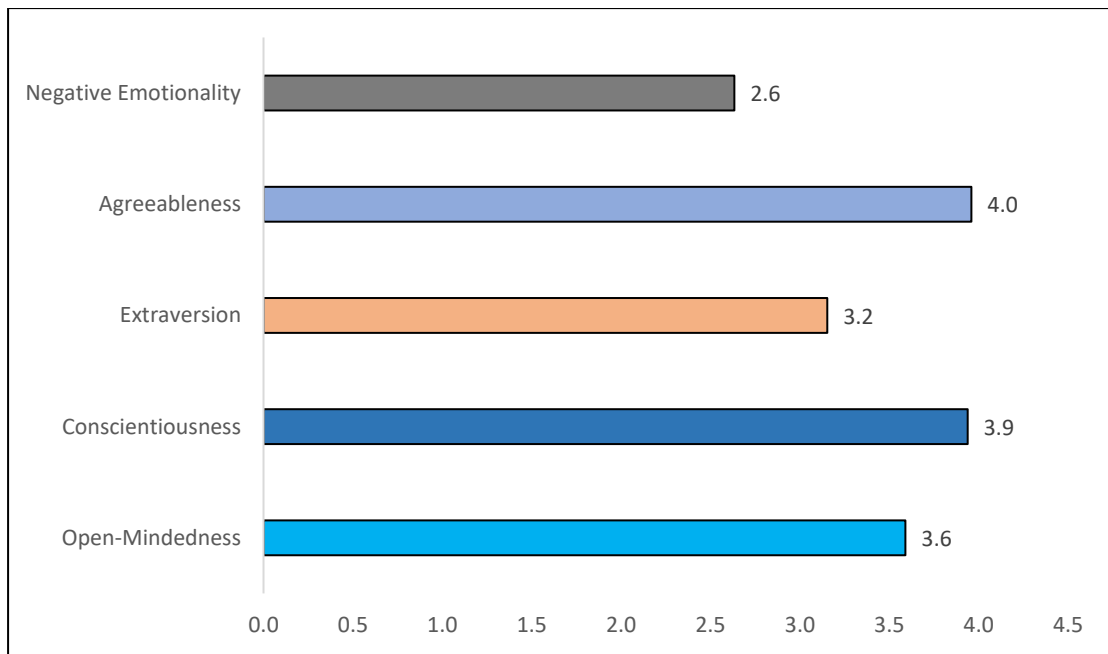

**Figure 6 Descriptive statistics of Psychological Capital by Position Level**

#### **4.2 Employee Personality: Statistical Descriptions**

The information on item-wise statistics for employee personality indicates that more than 80% of employees reliable and trustworthy who can be always counted on, compassionate with soft heart and full of energy and yet conscious and well organized. However, these personality items are grouped to form five different traits of personality namely: Open-mindedness, Consciousness, Extraversion, Agreeableness and Neuroticism.

To estimate inclination of employees in terms of personality traits, the traits were compared based on the mean scores. It can be understood that employees in general possess 'Agreeable' trait followed by 'Consciousness' and 'Open-mindedness' with values of 4, 3.9 and 3.6 respectively. On the other hand, the data shows that employees are least 'emotionally negative' and have moderate level of 'extraversion'. The detailed descriptive statistics are displayed in the figure.



**Figure 7 Overall Mean Values of Personality Traits**

The further tests were conducted to ascertain if personality differ by groups, based on sex, corporations they belong and the position level. Although an independent-samples t-test shows that personality (as a whole) does not differ based on sex, the score of Neuroticism (Negative Emotionality) are statistically significant for females ( $M=2.790$ ,  $SD=0.0568$ ) and male [ $M=2.549$ ,  $SD=0.0402$ ];  $t(508) = -.3497$ ,  $p=0.001$ ]. Also, despite the One-way ANOVA test showing significant difference of scores of Personalities as a whole, and Openness trait between the DHI corporations at  $p$  values of 0.04 and 0.022, the post-hoc multiple comparisons of Tukey HSD could not determine the differing groups. And on comparing the mean values by position levels, ANOVA result revealed the significance of 'Neuroticism' within position levels at  $p(0.046) > 0.05$ , but again post-hoc Tukey HSD could not identify which position level differs from which. The following is the descriptive statistics of the Personality traits by position level.

**Table 26 Personality traits by position level**

Position Level	Statistics	O	C	E	A	N
Executive	Mean	3.542	4.167	3.479	3.833	2.667
	SD	0.619	0.720	0.740	0.471	0.760
Managerial	Mean	3.643	4.026	3.210	3.907	2.526
	SD	0.544	0.709	0.722	0.635	0.738
Supervisory	Mean	3.544	3.913	3.090	4.069	2.594
	SD	0.553	0.768	0.605	0.592	0.723
Operational	Mean	3.583	3.882	3.130	3.903	2.731
	SD	0.604	0.725	0.655	0.631	0.767
General Service Category (GSC)	Mean	3.631	3.820	3.153	3.991	2.865
	SD	0.554	0.731	0.651	0.512	0.784
Total	Mean	3.591	3.939	3.154	3.960	2.634
	N	511	511	511	511	511
	SD	0.567	0.736	0.665	0.611	0.750

### Structural Equation Model (SEM)

#### 1. Steps in conducting SEM.

There are six basic steps involved in conducting any Structural Equation Model. These steps are laid out clearly by Kline (2015) as follows:

1. Specify the model
2. Evaluate model identification (if not identified, go back to step 1).
3. Select the measures (operationalize the constructs) and collect, prepare, and screen the data.
4. Estimate the model:
  - 4.1 Evaluate model fit; if poor, respecify the model, but only if doing so is justifiable (skip to step 5); otherwise, retain no model (skip to step 6).
  - 4.2 Assuming a model is retained, interpret the parameter estimates. c. Consider equivalent or near-equivalent models (skip to step 6).
5. Respecify the model, which is assumed to be identified (return to step 4).
6. Report the results.

These recommended steps were reference points in conducting the SEM in this study. Prior to collecting data, a-priori SEM model was specified and identified. This model identification also helped in determining the sampling size after tentative parameters (to be estimated) were known and positive degree of freedom determined. However, the option of re-specification was kept open to fit the data. A little bit of change was made in the model later. The details are discussed in the following sections under measurement and structural models.

## **2. Model Parameter Estimation**

There are different methods of model parameter estimation. There are two kinds of estimation: (i) Single equation method/Partial information method/limited information methods and (ii) Simultaneous/full-information methods. The first methods are known to be less effected by specification error; they do not assume multivariate normality, and do not require identified and correctly specified models. The second methods require identified models and can estimate all free model parameters simultaneously efficiently than the single equation methods. For the current statistical analysis, Maximum Likelihood (ML), a simultaneous method is adopted. According to Kline (2015) the ML can be “applied to whole range of structural equation models”, can estimate non-recursive casual relations in path models and also be able to analyze models with substantive latent variables. Most importantly, ML is applied in the case of multivariate normality of population distribution or with minor deviation from normality.

## **3. Composite Reliability and Construct Validity**

In the earlier section under data management-reliability and validity, the focus of discussion was reliability pertaining to internal consistency. The confirmation of reliability reported was based on the Cronbach alpha values. Composite Reliability (CR) is normally considered for the Structural Equation Model. This method of calculating reliability is based on the factor loadings of indicators of each construct achieved through Confirmatory Factor Analysis. And AMOS software does not automatically calculate (although there are plugins to run this), the CR values were calculated by the researcher using the excel spreadsheet based on the statistical formula suggested by Collier (2020). The formula used for calculating Composite Reliability was:



$$\frac{(\text{sum of standardized loadings})^2}{(\text{sum of standardized loadings})^2 + (\text{sum of indicator measurement error})}$$

Or statistically,  $CR = \frac{(\sum \lambda_i)^2}{(\sum \lambda_i)^2 + (\sum \epsilon_i)}$ , where:  $\lambda$  (lambda)=standardized factor loading for item  $i$  and  $\epsilon$ = respective error variance for item  $i$ .

**Note:**  $r^2 = \lambda_i^2 = 1 - \epsilon_i$

For more accurate result out of the analyses of Structural Equation Model, Construct validity, namely convergent and discriminant validity were also performed. When the indicators are designed as reflective, the “assessment of reliability, unidimensionality, discriminant validity, and convergent validity are all meaningful tests” (Collier, 2020). To put this information into the context, indicators of the latent variables for the current model were arranged as reflective rather than formative. The Average Variance Extracted (AVE) values, in other words, the average of standardized coefficients ( $r^2$ ) for indicators of the same factor were calculated to determine the convergent validity. For the establishment of this validity, the value of AVE must be at least 0.5.

Another criterion for construct validity is discriminant validity. While the convergent validity examines the items constituting the factor, the convergent validity considers how different constructs are distinct from each other. In fact, the fundamental difference is that is that convergent validity tests whether indicators come together to measure a single concept, whereas discriminant validity evaluates if a construct is distinguishable from other factors. One method of ascertaining discriminant validity is through comparison of shared variance between the latent constructs. According to Collier (2020), the value of AVE should be always higher than the shared variance between construct to establish discriminant validity. This is basically the Fornell and Larcker (1981) criterion which states each construct’s average variance extracted (AVE) must be compared with its squared correlations

with other constructs in the model; and if a latent variable accounts for more variance in its associated indicator variables than it shares with other constructs in the same model, the discriminant validity is achieved. This is perhaps the most traditional and oldest method.

Another technique, a slightly different is through the comparison of squared root of AVE with the correlation coefficients. The validity is also ascertained if the square root of AVE is higher than the correlation coefficients of constructs. And yet, the newest and seemingly more accurate measure of discriminant validity, especially for variance based Structural Equation Modelling is through “heterotrait-monotrait ratio (HTMT)” of the correlations recommended by Henseler et al. (2015) as a result of the examination of efficiency of methods based on Fornell-Lacker Criterion and Cross-Loadings. They observed that the Fornell-Larcker criterion wrongly ascertained discriminant validity for at least 54 out of 500 (10.8%) cases. This indicates that this method can be an issue where researcher would sometimes be mistakenly made to believe that discriminant validity is established.

The HTMT method is more modern and proved to detects the validity more correctly; of course, there is also very recent assertion that HTMT2 (both numerator and denominator is a geometric mean unlike HTMT where numerator is an arithmetic mean instead) is even better. The **Heterotriat-monotrait** method considers the average of the heterotrait-heteromethod correlations relative to the average of the monotrait-heteromethod correlations. In other words, HTMT is basically the ratio of arithmetic mean of correlations of indicators across constructs measuring different phenomena and the geometric mean of correlations of indicators across constructs measuring correlations of indicators within the same construct. The actual formula of Henseler et al. (2015) for HTMT is represented as:

$$\text{HTMT}_{ij} = \frac{1}{K_i K_j} \sum_{g=1}^{K_i} \sum_{h=1}^{K_j} r_{ig,jh} \div \left( \frac{2}{K_i (K_i - 1)} \sum_{g=1}^{K_i-1} \sum_{h=g+1}^{K_i} r_{ig,ih} \frac{2}{K_j (K_j - 1)} \sum_{g=1}^{K_j-1} \sum_{h=g+1}^{K_j} r_{jg,jh} \right)^{\frac{1}{2}}$$

However, this complex formula can also be presented much simpler as follows:

$$HTMT_{ij} = \frac{A}{\sqrt{B.C}} \text{ were,}$$

**A**=the average hetrotrait-heteromethod correlations (mean of all pairwise correlations of items of first construct *i* and second construct *j*);

**B**= the average montrait-heteromethod correlations of first construct items (mean of all pairwise correlations between items of first construct *i*); and

**C**= the average montrait-heteromethod correlations of second construct items (mean of all pairwise correlations between items of second construct *j*)

Both the traditional Fornell-Larcker criterion and modern HTMT (Heterotrait-Monotrait ratio) methods have been used side by side to determine the discriminant validity. The details of these reliability and validity statistics are discussed later under analysis of measurement models.

#### **4. Model Fit Assessment**

The model needs to fit the data. The fitness implies that the specified model (estimated covariance matrix) is a close representation of the data (observed covariance matrix). On the contrary, a bad fit suggests otherwise (Collier, 2020). The ultimate reason behind model fit assessment is to make sure that the overall structure of the model fits the data. Of course, there are many ways to determine model fitness. Most common and prominent include: 1) Goodness of fit test (Model Chi-Square Test); 2) Comparative/Incremental fit statistics (Comparative Fit Index-CFI, Incremental Fit Index-IFI, Normed Fit Index-NFI, Tucker Lewis Index-TLI, Relative Fit Index-RFI); and 3. Badness of fit test (Root Mean Square Error of Approximation-RMSEA).

#### **5. Analysis of Measurement Models**

The current overall Structural Equation Model is composed of four latent Constructs. These factors are Leadership (as higher order factor), GNH in Corporation, Psychological Capital, and Self rated Employee Performance. For the Leadership designed as second factor higher order factor, the first factors leadership Skills, Awareness, Character, and Behaviour. As a preparatory activity for the SEM

analysis, the Confirmatory Factor Analysis (CFA) for the measurement models are conducted. The CFA was conducted at both individual factor level and overall measurement model level. For the Leadership Variable, CFA was conducted at first order factors first and then at higher order level. Their model fit statistics are almost identical.

### **5.1 Confirmatory Factor Analysis: Leadership**

The CFA is conducted for the first factors of Leadership. The Skills, Awareness and Character factors have three reflective indicators each while Behaviour factor has two indicators. In terms of the factor loadings, all items have a minimum standardized value of 0.7. So, all items are retained for further analysis. The model fit statistics also show that the model is somewhat fit. Although the p value of Chi-square test should be  $>0.05$ , the current measurement model implied that the model and the data do not match. However, the reliance on p value alone may be flawed as it is sensitive to the sample size. Another way of interpreting the 'goodness of fit' is CMIN/DF value. The Generally acceptable value is 5. Hence, the value of 3.522 is within this cut-off threshold implying the qualification of goodness of fit test. Based on the badness of fit test with RMSEA value of 0.07 also indicate the model fit. RMSEA value should be less than 0.8. All the values of comparative statistics namely NFI, RFI, IFI and TLI are exceeds 0.9 suggesting strong model fit. The visual representation of first order CFA of leadership is presented in the following figure.

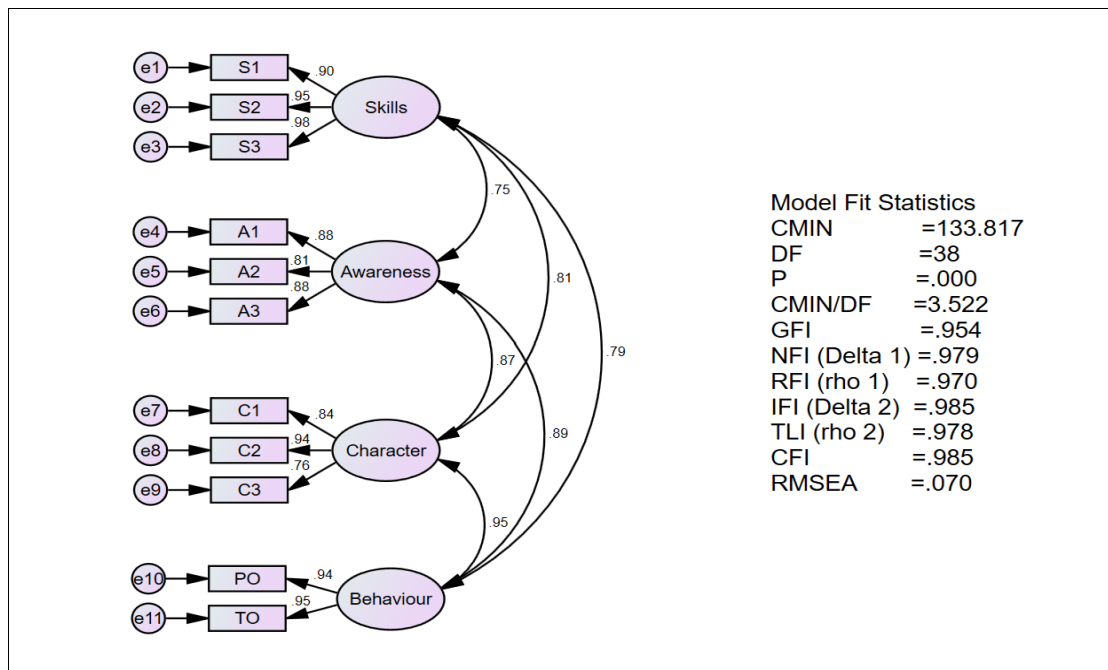

**Figure 8 Measurement Model 1: First Factor CFA for Leadership Variable**

The convergent validity and the composite reliability statistics of these first factors are good. All factors comfortably met the required threshold of both the qualifying criteria. The minimum AVE value required to establish Convergent validity is 0.5, and Skills, Awareness, Character, and Behaviour have AVE values of 0.89, 0.73, 0.72 and 0.89 respectively. All factors have identical values of Composite Reliability (CR) and AVE except the skills construct, where value of CR stands at 0.85 instead. At least a value of 0.7 is expected to achieve composite reliability. While Composite reliability and convergent validity are assessed at these factors level, the discriminant validity is ignored considering that these factors are in fact poised as indicators for the higher construct, and Discriminant validity is assessed at higher order construct. The details of convergent validity and composite reliability is presented in the following table.



**Table 27 Convergent Validity & Composite Reliability of first factors**

Constructs	Indicators	Factor Loading	R <sup>2</sup>	AVE	ΣR <sup>2</sup>	ε=1-R <sup>2</sup>	Σε	CR
<b>Skills</b>	Technical Skills	0.9	0.81	<b>0.89</b>	1.86	0.19	0.33	<b>0.85</b>
	Human Skills	0.95	0.9			0.1		
	Conceptual Skills	0.98	0.96			0.04		
<b>Awareness</b>	Technological	0.88	0.77	<b>0.73</b>	2.2	0.23	0.8	<b>0.73</b>
	Socio-Eco-politico	0.81	0.66			0.34		
	Legal & Policy	0.88	0.77			0.23		
<b>Character</b>	Ethical Commitment	0.84	0.71	<b>0.72</b>	2.17	0.29	0.83	<b>0.72</b>
	Authentic Influence	0.94	0.88			0.12		
	Self-Belief	0.76	0.58			0.42		
<b>Behaviour</b>	Task Orientation	0.95	0.9	<b>0.89</b>	1.78	0.1	0.22	<b>0.89</b>
	People Orientation	0.94	0.88			0.12		

Taking higher order leadership for the measurement model, the standardized factor loadings of first factors, Skills, Awareness, Character, and Behaviour towards the higher order leadership are 0.82, 0.90, 0.98 and 0.97 respectively. This indicates that at least 67% of variances of leadership is explained by each these factors (they are in fact designed as indicators in the form of item parcels in this model). The higher order factor of Leadership also shows the good model fit. Although the Chi square value is significant (<.05), the other statistics show that the model fits well with the data. The CMIN/DF is 3.495 (which is below 5), GFI stands at 0.952 (more than 0.8). All the values of NFI, RFI, IFI, TLI and CFI are more than 0.9. The RMSEA value is 0.07 (should be below 0.8). The details are provided in the following measurement model figure.

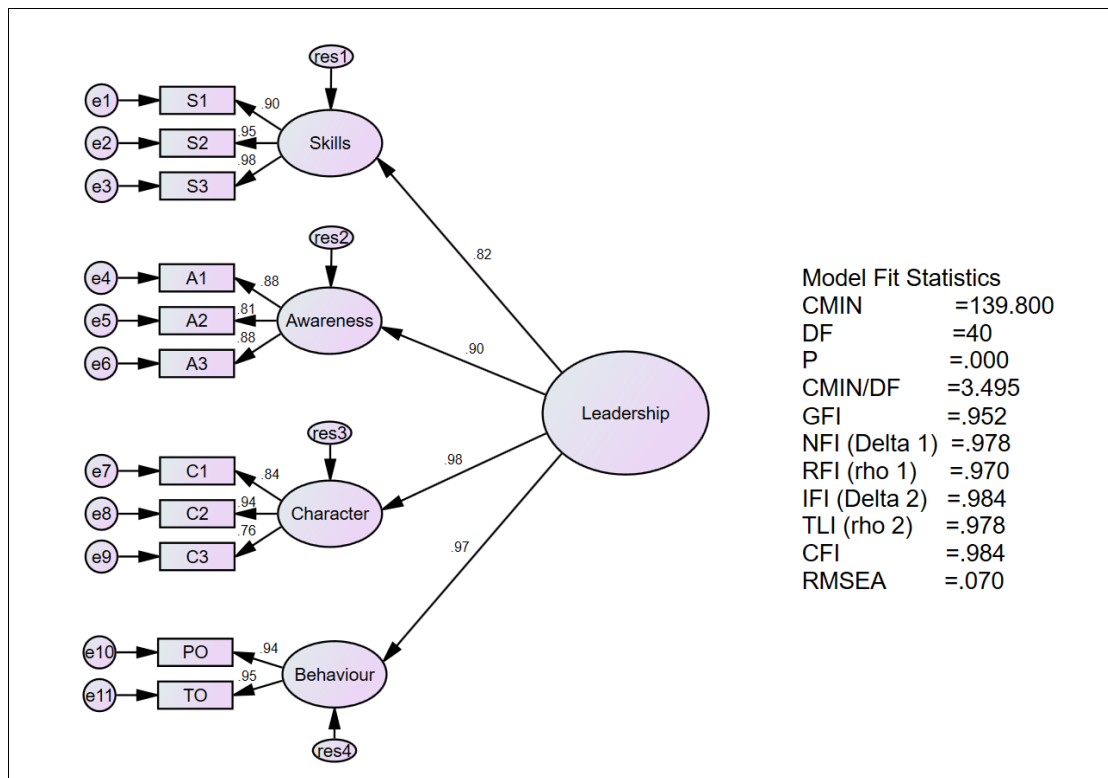
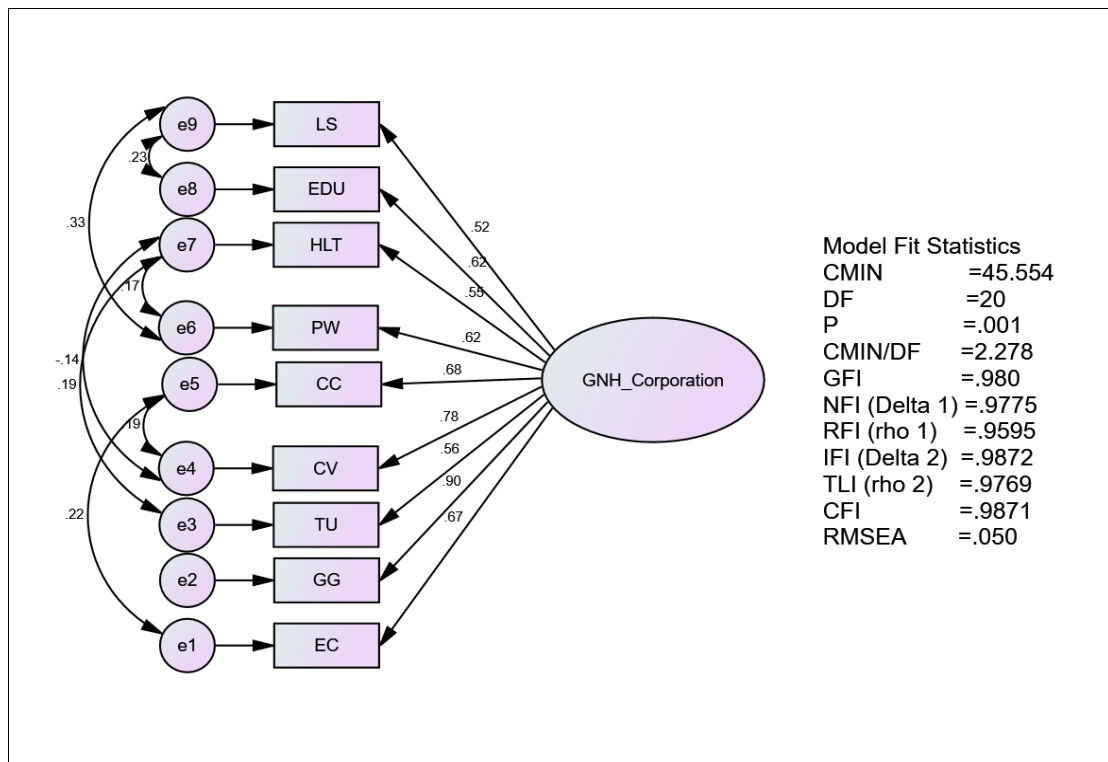

**Figure 9 Measurement Model 2: Second Factor CFA for Leadership Variable**

## 5.2 Confirmatory Factor Analysis: GNH in Corporation

Initially, the Confirmatory Factor Analysis was conducted on GNH in Corporation as a factor composed of nine reflective indicators. The result clearly indicated data-model misfit. In addition to having the significant Chi square p value, the CMIN/DF was 7.787 which was higher than the maximum threshold of 5, and the RMSEA value was 0.115 which should be less than 0.08. Moreover, values of NFI, RFI and TLI were only marginally fit with 0.896, 0.861, 0.877 respectively; the commonly used cut-off value for these statistics is 0.9. Thus, modification indices were referred. Of course, the covariances of error terms have been identified so that it produces highest modification indices. It was noted that covarying e6 and e9, e8 and e9, e1 and e5, e3 and e7, e6 and e7, e4 and e7, and e4 and e5 would reduce the chi square value would be reduced by 52.326, 26.432, 19.426, 17.03, 15.1444, 14.868, and 14.247 (modification indices) respectively. Hence, as a part of improving data-model fit, these seven covariances (of error terms) were added. This modification has

in fact improved and achieved the model fit for ‘GNH in Corporation’ construct. The CMIN/DF within the threshold value of 5, while GFI, NFI, RFI, IFI, TLI AND CFI all have values more than 0.9. The RMSEA value stands at 0.050. The detailed values are presented in the following figure:

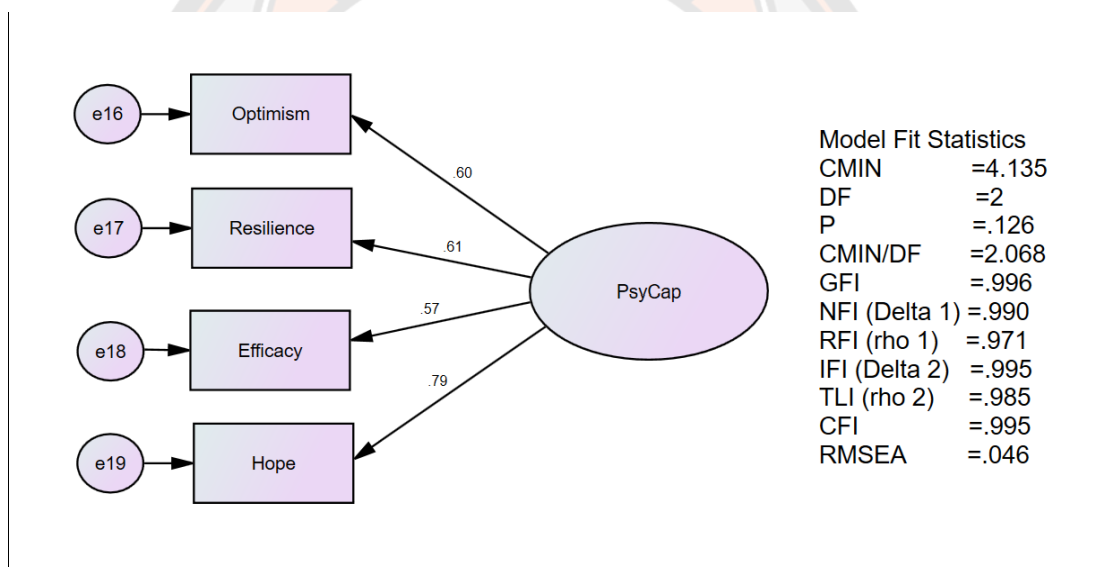

**Figure 10 Measurement Model 3: CFA of GNH in Corporation**

### 5.3 Confirmatory Factor Analysis: Psychological Capital

This measurement model of Psychological Capital exudes perfect model-data fit. It passes the ‘goodness of fit’ test with the chi square p value of 0.126, comparative statistics test of NFI, RFI, IFI, TLI and CFI with value exceeding 0.9. The ‘badness of fit’ test with RMSEA value of 0.46 also confirms the model fit. Hence, no modification to the model was required. However, the factor loadings of the four indicators (Hope, Efficacy, Resilience, Optimism) were not impressive. Only Hope as an indicator for the Psychological Construct has value more than 0.7 (Optimism, Resilience and Efficacy have 0.60, 0.61 and 0.57 respectively). Of course, these factors are designed as indicators through item parceling. Even considering the

test of internal consistency of items, the Cronbach alpha values for Resilience and Optimism were just 0.51 and 0.47 although Efficacy and Hope have 0.8 and 0.72. However, all the items have been preserved. The Psychological Capital Questionnaire (PCQ-12), shorter version of PCQ-24 developed by Luthans, Avolio, et al. (2007), was the survey instrument used for collecting data pertaining to respondent's psychological capital. This tool had been already validated and used widely. For example, the PCQ-12 was found to be reliable and valid by Rus et al. (2012) and Santana-Cárdenas et al. (2018) in their studies. However, the later study reveals that cultural factors may play a part how construct behaves. The detailed statistics of the CFA for Psychological Capital is presented in the following figure.



**Figure 11 Measurement Model 4: CFA of Psychological Capital**

#### 5.4 Confirmatory Factor Analysis: Employee Performance

In the overall Structural Equation Model, the Employee Performance has just two indicators (Actual Performance and the Self-Reported performance). The rules for standard CFA model states that, a model with a single factor should have at least three indicators while for a model with two or more factors, each factor should have at least two indicators (Kline, 2015). If this rule is fulfilled, the model would be then identified. Thus, going by this rule, Employee Performance as a single factor

with just two indicators was under-identified model. Thus, the aggregated Self-reported Performance as a single indicator has been split into three indicators as 'Task Performance', 'Contextual Performance' and 'Counterproductive work behaviour'. Thus, the model with four indicators (Actual Performance, Task Performance, Contextual Performance, and Counterproductive Behaviour) was subjected to Confirmatory Factor Analysis.

Although, the  $e_1$  and  $e_2$  error terms were covaried for the sake of model fit, there was strong indication about the requirement to modify the Employee Performance measurement model in the overall Structural Model. This is because, the standardized factor loadings for 'Actual Performance' and 'Counterproductive Work Behaviour' were too low at 0.21 and 0.09 respectively. The perfect model fit statistics was not so important for this model; perhaps, the most important outcome from this CFA is that it helped in re-specifying the overall SEM. The Actual Performance indicator will not be included as indicator; In fact, only the dis-aggregated Self-reported performance indicators, 'Task Performance' and 'Contextualized Performance' were decided be the final indicators of employee performance. The Counterproductive Work Behaviour indicator will not be included owing to unsatisfactory factor loading. While the standard factor loading value is 0.7, some suggest a minimum of 0.5 is acceptable.

The result of CFA for Employee Performance Model is given in the following figure.



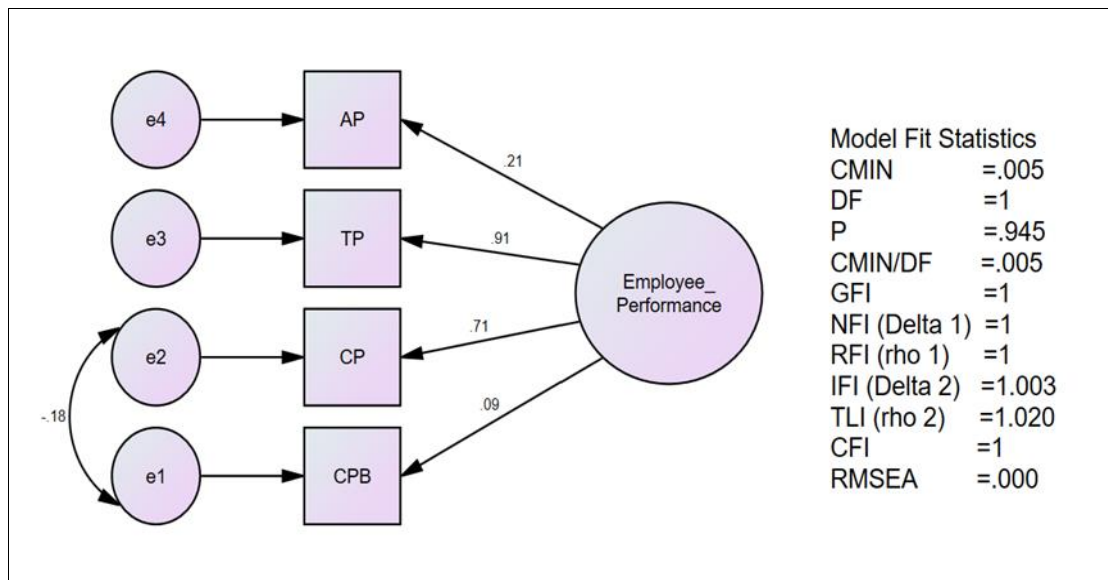

**Figure 12 Measurement Model 5: CFA of Employee Performance**

The summary of model fit statistics for individual measurement models are given in the following table.

**Table 28 Summary of Model Fit Statistics of individual measurement models**

Model Fit Statistics	Leadership	<sup>1</sup> GNH	<sup>2</sup> PsyCap	Performance
CMIN	139.8	45.554	4.135	0.005
DF	40	20	2	1
P	.000	.001	.126	0.945
CMIN/DF	3.495	2.278	2.068	0.005
GFI	0.952	0.980	0.996	1
NFI (Delta 1)	0.978	.9775	.990	1
RFI (rho 1)	0.97	.9595	.971	1
IFI (Delta 2)	0.984	.9872	.995	1.003
TLI (rho 2)	0.978	.9769	.985	1.02
CFI	0.984	.9871	.995	1
RMSEA	0.07	.050	.046	0

**Note:** 1. GNH=GNH in corporation

2. PsyCap=Psychological Capital

### 5.5 Confirmatory Factor and Reliability Analysis

To run the Structural Model, it is also important to ascertain the construct reliability and the validity. All the four factors qualify the composite reliability. The values of composite reliability for Leadership, Psychological Capital, GNH in Corporation, and Employee Performance stand at 0,96, 0.74, 0.88, and 0.79 in the same order. The minimum value required is 0.7. The details of composite reliability for each factor are given in the following table.

**Table 29 The Composite Reliability based on the CFA**

Indicators	<---	Constructs	Factor Loading	t-Value	Composite Reliability
Awareness	<---		0.91	19.48	
Character	<---	Leadership	0.97	17.6	<b>0.96</b>
Skills	<---		0.82	**	
Behaviour	<---		0.98	23.06	
Optimism	<---		0.6	**	
Resilience	<---	Psychological	0.57	10.02	<b>0.74</b>
Efficacy	<---	Capital	0.61	10.62	
Hope	<---		0.79	12.18	
Living Standard	<---		0.52	**	
Education & Training	<---		0.62	11.53	
Concern for Culture	<---		0.68	10.74	
Good Governance	<---	GNH in Corporation	0.90	12.17	<b>0.87</b>
Concern for Environment	<---		0.67	10.68	
Psychological Wellbeing	<---		0.62	12.36	
Health	<---		0.55	9.45	
Time Use	<---		0.56	9.55	
Community Vitality	<---		0.78	11.51	
Task Performance	<---	Performance	0.76	**	<b>0.79</b>
Contextual Performance	<---		0.85	13.49	

\*\*=Items constrained for identification purposes

### 5.6 Construct validity

Convergent validity tests if the indicators converge together to measure the factor. And the value of convergent validity is based on the factor loadings of each indicator with more the better. The rationale behind experts recommending factor loading to be greater than 0.7 is to make sure the items explain at least almost 50% ( $R^2=0.7*0.7=0.49$ ) variance than errors. In fact, the convergent validity is established if the Average Variance Extracted (AVE) is at least 0.5, and AVE is the average of squared factor loadings ( $R^2$ ). And it is interesting to note that while two factors (Leadership, and Performance) meet the AVE criterion, the Psychological Capital (PsyCap) and GNH in Corporation constructs slightly fall short of achieving 0.5 threshold. The point is PsyCap data was collected using already validated PCQ-12. Even though these constructs seem to have a little issue in terms of convergent validity, the overall Cronbach's alpha and composite reliability value indicated the factors are reliable. The issue could be due to the contextual situation. Hence, the Psychological Capital and GNH in Corporation Constructs were not ignored but considered for further analysis. The details are presented in the following:

**Table 30 Convergent Validity: Leadership and Psychological Capital**

Indicators	<--- Constructs	Factor Loading	R <sup>2</sup>	*AVE
Awareness	<---	0.91	0.83	
Character	<---	0.97	0.94	<b>0.85</b>
Skills	<---	0.82	0.67	
Behaviour	<---	0.98	0.96	
Optimism	<---	0.6	0.36	
Resilience	<---	0.57	0.32	<b>0.42</b>
Efficacy	<---	0.61	0.37	
Hope	<---	0.79	0.62	

\*AVE=Average Variance Extracted

**Table 31 Convergent validity: GNH in Corp and Employee Performance**

Indicators	<---	Constructs	Factor Loading	R <sup>2</sup>	*AVE
Living Standard	<---		0.52	0.27	
Education & Training	<---		0.62	0.38	
Concern for Culture	<---		0.68	0.46	
Good Governance	<---		0.90	0.81	
Concern for Environment	<---	GNH in	0.67	0.45	<b>0.44</b>
Psychological Wellbeing	<---	Corporation	0.62	0.38	
Health	<---		0.55	0.30	
Time Use	<---		0.56	0.31	
Community Vitality	<---		0.78	0.61	
Task Performance	<---		0.76	0.58	<b>0.65</b>
Contextual Performance	<---	Performance	0.85	0.72	

Discriminant Validity is yet another test for the construct validity. The Fornell-Larcker criterion of Fornell, & Larcker (1981) has been the widely used. They state that if the Average Variance Extracted (AVE) is greater than the value of squared correlation coefficients, the discriminant validity is ascertained. The AVE of Leadership, GNH in Corporation, PsyCap and Performance are 0.85, 0.44, 0.42, and 0.65 respectively. The AVE of Leadership (0.85) is higher than its squared correlation coefficient (mentioned within brackets and italicized) with GNH in corporation (.27), PsyCap (0.8), performance (.11). The AVE of GNH in Corporation (0.44) is greater than its squared correlation coefficients with other constructs. Similarly, the AVEs of PsyCap and Performance are also higher than the squared correlation coefficients shared with other constructs.

Also, another way of interpretation is that, to determine discriminant validity, the value of square root of AVEs should be higher than the shared correlation coefficients. The square root of AVE of Leadership, GNH in Corporation, Psychological Capital and Performance are 0.922, 0.664, 0.646 and 0.806 in the same order. These values are comparatively higher than the shared correlation values. Thus,

taking Fornell-Larcker criterion, the discriminant validity is established for the factors of Structural Equation Model. The details are provided in the following table:

**Table 32 Discriminant Validity based on Fornell-Larcker Criterion**

	<sup>1</sup> CR	AVE	Leadership	GNH	PsyCap	Performance
Leadership	0.96	0.85	<b>0.85 [.922]</b>			
GNH	0.87	0.44	.523(.27)	<b>0.44 [.664]</b>		
PsyCap	0.74	0.42	.288(.08)	.470 (.22)	<b>0.42 [.646]</b>	
Performance	0.79	0.65	.332 (.11)	.352 (.12)	.492 (.24)	<b>0.65 [.806]</b>

**Note:** 1 CR=Composite Reliability

Based on the Fornell-Larcker criterion, all the four constructs are distinctively unique and discriminate from each other. However, this method has the sensitivity issue of being wrongly identifying discriminant validity (Henseler et al., 2015). In fact, these authors have extrapolated the result based on the simulation study that Fornell-Larcker criterion and assessment of cross loadings were not satisfactory measure of discriminant validity. They recommended ‘Heterotrait-Monotrait ratio (HTMT)’ as a best alternative. This method determines the discriminant validity based on the calculations of correlation coefficients. The process of deriving the HTMT value has been already discussed earlier under the ‘Composite reliability and Construct validity’. First the following correlation matrix was generated prior to further calculations.



Leadership				GNH in Corporation										Psychological Capital					Performance	
	S	A	C	B	LS	EDU	HLT	PW	CC	CV	TU	GG	EC	E	H	R	O	TP	CP	
S	1																			
A	.694**	1																		
C	.746**	.782**	1																	
B	.748**	.807**	.865**	1																
LS	.211**	.210**	.211**	.230**	1															
EDU	.259**	.295**	.268**	.292**	.490**	1														
HLT	.260**	.235**	.277**	.282**	.320**	.347**	1													
PW	.314**	.349**	.321**	.363**	.555**	.435**	.468**	1												
CC	.355**	.415**	.438**	.421**	.316**	.397**	.366**	.456**	1											
CV	.395**	.433**	.402**	.459**	.357**	.462**	.353**	.477**	.622**	1										
TU	.287**	.275**	.307**	.325**	.414**	.359**	.442**	.401**	.412**	.433**	1									
GG	.467**	.506**	.512**	.544**	.467**	.556**	.497**	.532**	.608**	.700**	.483**	1								
EC	.366**	.407**	.382**	.403**	.304**	.382**	.348**	.384**	.578**	.533**	.327**	.619**	1							
E	.232**	.291**	.285**	.281**	.283**	.302**	.244**	.416**	.330**	.399**	.267**	.396**	.306**	1						
H	.196**	.216**	.215**	.244**	.232**	.231**	.107**	.407**	.326**	.350**	.207**	.302**	.314**	.473**	1					
R	.090**	.117**	.144**	.112**	.145**	.122**	-.045**	.141**	.204**	.243**	.148**	.157**	.200**	.316**	.477**	1				
O	.163**	.181**	.190**	.182**	.210**	.168**	.140**	.368**	.403**	.331**	.222**	.311**	.351**	.330**	.467**	.403**	1			
TP	.172**	.302**	.232**	.316**	.149**	.169**	.136**	.343**	.357**	.339**	.243**	.285**	.237**	.291**	.453**	.240**	.240**	1		
CP	.151**	.337**	.287**	.335**	.103**	.200**	.032**	.310**	.379**	.360**	.143**	.262**	.262**	.370**	.459**	.313**	.312**	.645**	1	

**Leadership:** S=Skills, A=Awareness, C=Character, B=Behaviour  
**GNH in Corporation:** LS=Living Standard, EDU=Training & Education, HLT=Health, CC=Concern for Culture, CV=Community Vitality, TU=Time Use, GG=Good Governance, EC=Concern for Environment  
**Psychological Capital:** E=Efficacy, H=Hope, R=Resilience, O=Optimism.  
**Performance:** TP=Task Performance, CP=Contextual Performance

Figure 13 Correlation matrix of variables for HTMT calculation

The average monotrait correlations for each construct was established by averaging each inter-correlations between items of the construct; mono-trait correlations for Leadership, GNH in Corporation, Psychological Capital are 0.774, 0.45, 0.411 and 0.645 respectively. This information is presented in the following table:

**Table 33 Average monotrait correlations**

Variable	Average monotrait Correlation
Leadership	0.774
GNH in Corporation	0.450
Psychological Capital	0.411
Performance	0.645

Once the heterotrait and monotrait correlations are determined using heterotrait and monotrait methods, the HTMT value was obtained as displayed in the table. The detailed process of calculating HTMT was discussed in section 5.4.3 ‘composite reliability and construct validity’. Thus, the discriminant validity is established even based on the HTMT method as all the values are less than 0.85. According to Henseler et al. (2015) if the value exceeds 0.85, it indicates issue of discrimination and should be less than 0.85.

**Table 34 HTMT values of the construct**

Variable Pair	<sup>1</sup> A	<sup>2</sup> B	<sup>3</sup> SQRT of B	HTMT Ratio
Leadership & GNH	0.35	0.348	0.590	0.59
Leadership & PsyCap	0.2	0.318	0.564	0.35
Leadership & Performance	0.27	0.499	0.707	0.38
GNH & PsyCap	0.26	0.185	0.430	0.60
GNH & Performance	0.24	0.290	0.539	0.45
PsyCap & Performance	0.33	0.265	0.515	0.64

**Note:** 1 Average Heterotrait Correlation

2. Monotrait Correlations Product

3. SQRT=Square root

For easy reference and inference, the HTMT information is summarized in the table. Although, the table looks just like a correlation matrix, the given values are HTMT values of a pair of constructs. Leadership construct discriminates from other three constructs with HTMT values of 0.59, 0.35, and 0.38 respectively. Each construct is in essence distinctive and unique from other. It can be deduced from the information presented in the table.

**Table 35 Simplified HTMT table**

	Leadership	<sup>1</sup> GNH	<sup>2</sup> PsyCap	Performance
Leadership	*			
GNH in Corporation	0.59	*		
Psychological Capital	0.35	0.6	*	
Performance	0.38	0.45	0.64	*

**Note:** 1. GNH=GNH in Corporation  
2. PsyCap=Psychological Capital

## 6. Analysis of Structural Model

The following figure represents full Structural Equation Model and takes the recursive form. Of the total of 351 distinct sample moments in the model, 70 parameters were needed to be estimated which result in degrees of freedom at 281 (351-70). The degree of freedom should be at least 0. The overall model contains 70 regression weights (42 fixed and 28 unlabeled), 8 covariances (unlabeled), and 34 variances (unlabeled). In terms of the variables, there are 68 in total out of which 26 are observed and 42 unobserved variables. And 68 variables are equally divided into 34 each as exogeneous and endogenous. Well, this final model is a little deviation from the initial a-priori model which contained 51 parameters to be estimated. This is a result of specification of the model. Initially, the four first order factors (Skills, Awareness, Character, and Behaviour) of leadership variable, and the 9 indicators of GNH in Corporation were designed and formative indicators. But in the final

specification, these were better fit as reflective indicators. Hence, a deviation in the model. The Structural Equation Model is presented in the following figure:

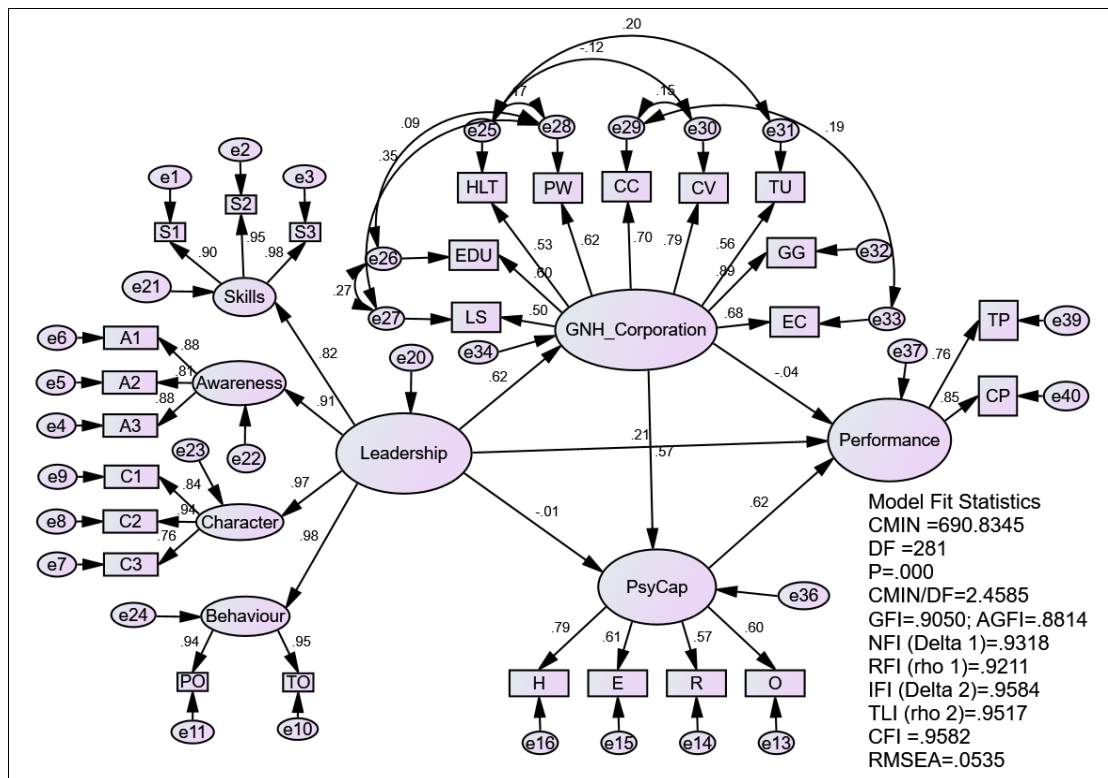

**Figure 14 Structural Equation Model**

### 6.1 Structural Model: Model Fit Analysis

The model fits the data. The preliminary fit tests have been already conducted through measurement models. Although the p value of Chi square is significant, the other statistics indicate model fit. The p value is sample sensitive after all. The CMIN/DF value is within 5, GFI, AGFI and PGFI all have values more than 0.8. In terms of baseline comparative statistics, the values representing NFI, RFI, IFI, TLI and CFI are all above 0.90. The RMSEA value is less than 0.08. Hence, the model fit is determined. The data-model fit information is presented in the following table:

**Table 36 Model fit statistics for Structural Model**

Model Fit Test Type	Statistical Values				
	<b>NPAR</b>	<b>CMIN</b>	<b>DF</b>	<b>P</b>	<b>CMIN/DF</b>
Goodness of Fit	70	690.835	281	0.000	2.4585
RMR, GFI	<b>RMR</b>	<b>GFI</b>	<b>AGFI</b>	<b>PGFI</b>	
	0.0377	0.9050	0.8814	0.7245	
Incremental test statistics	<b>NFI</b>	<b>RFI</b>	<b>IFI</b>	<b>TLI</b>	<b>CFI</b>
	0.931	0.921	0.958	0.952	0.958
Badness of fit	<b>RMSEA</b>	<b>LO90</b>	<b>HI90</b>	<b>PCLOSE</b>	
	0.0535	0.0485	0.0585	0.1254	

## 6.2 Interpretation: Overall Structural Equation Model

The information based on the regression weights are presented in the following table. The standardised weights are reflected as bold and italicised in brackets just beside unstandardised values. Based on this primary model, the pairs of variables: the Leadership and GNH in the Corporation, GNH in Corporation and Psychological Capital, Leadership and Performance, Psychological Capital of employees and Performance all have statistically significant relationships as indicated by the p values  $<.005$ . To put simply, the leadership in the corporations influences the level of GNH in Corporation and employee performance. Similarly, the GHN in corporation influences Psychological Capital of employees while the later ultimately determine the performance. However, Leadership does not seem to make difference in employees' psychological Capital at  $p(0.79) >.05$ ; and GNH in Corporation also does not translate into employee performance with  $p(0.7) >.05$ . In fact, their relationships are inverse as exhibited through negative estimate values (-.016 and -.028 respectively) in the proposed overall structural model. The negative regression must be a matter of interventions due to the presence of interfering effect in the model. In particular, the strong relationship between GNH in corporation and psychological capital could be the reason for these negative and insignificant relationships. Hence, although, these pairs of relationships within the full structural model seems to be insignificant, it is premature to conclude straight away. This is because, these relationships are designed as both independent and dependent variables allowing the



influences on and from different directions. The information in the following table is based solely on the overall structural model.

**Table 37 Regression weights and significance value**

Variable 2	<---	Variable 1	Estimate ( $\beta$ )	S.E.	C.R.	P
<sup>1</sup> GNH	<---	Leadership	0.2523 (.6176)	0.0273	9.2439	***
<sup>2</sup> PsyCap	<---	Leadership	-0.0043 (-.0109)	0.024	-0.1779	0.86
PsyCap	<---	GNH	0.5476 (.5719)	0.0819	6.6874	***
Performance	<---	Leadership	0.0802 (.2096)	0.0225	3.5728	***
Performance	<---	GNH	-0.0375 (-.04)	0.0676	-0.5542	0.58
Performance	<---	PsyCaP	0.6072 (.6201)	0.0787	7.7148	***

**Note:** 1. GNH=GNH in Corporation  
2. PsyCap=Psychological Capital

When the relationships are tested separately, the regression weight (unstandardised=.132; standardised=0.338) of Leadership on Psychological Capital is not only positive but significant with  $p < .05$ . The same is true where the influence of GNH in Corporation on Performance is significant [ $p < .001$ ], with the estimate value changed to 0.45 when these variables are tested separately as dependent and independent variables. And even the presence of mediators, these relationships remain significant; their relationships and the intervening effect of mediator variables are analysed in separate models later. These are based on the Structural Equation Models. Also, as an additional inquiry, the hierarchical multiple regression was conducted; the leadership, GNH in Corporation and Psychological Capital are regressed as predictor variables on employee performance (task and contextual) as criterion variable. Two models were generated; the first model, model 1 shows that the relationship between GNH in Corporation and output variable is significant with  $p < .001$ ; in fact, a little more than 12 percent of the variance of the dependent variable can be explained by the predictor variable. This clearly shows that, more the GNH in Corporation better the employee performance, at least in terms of self-rated task and contextual performance. However, the important focus is on uncovering why these two variables

show negative and insignificant relationship when put into the overall Structural Equation Model. This is partly explained by the nested model, Model 2 of the hierarchical multiple regression. When the Leadership and Psychological Capital are added to the GNH in Corporation as predicting variables, the change in F statistic is not only significant but the combined independent variables account for 28 percent of the variability of self-rated performance as compared to mere 12 percent when GNH in Corporation is poised as single predictor. The results of model 2 indicate a noticeable improvement as shown in following model summary and ANOVA tables.

**Table 38 Hierarchical multiple regression model summary**

Model	R	R <sup>2</sup>	Adjusted R <sup>2</sup>	Change Statistics				Sig. F Change
				R <sup>2</sup> Change	F Change	df1	df2	
1	.352 <sup>a</sup>	.124	.122	.124	72.004	1	509	.000
2	.533 <sup>b</sup>	.284	.280	.160	56.782	2	507	.000

a. Predictors: (Constant), GNH in Corporation

b. Predictors: (Constant), GNH in Corporation, PsyCap, Leadership

**Table 39 ANOVA table of hierarchical multiple regression model**

Model		Sum of Squares	df	Mean Square	F	p
1	Regression	22.934	1	22.934	72.004	.000 <sup>b</sup>
	Residual	162.119	509	.319		
	Total	185.053	510			
2	Regression	52.602	3	17.534	67.117	.000 <sup>c</sup>
	Residual	132.451	507	.261		
	Total	185.053	510			

a. Dependent Variable: Performance (Task and Contextual)

b. Predictors: (Constant), GNH in Corporation

c. Predictors: (Constant), GNH in Corporation, PsyCap, Leadership

The point is both the models reflect a significant relationship between independent variable(s) and response variable. However, when the significance of each predicting variable in model 2 is analyzed, the significance of GNH in Corporation on employee performance disappears with  $p (.171) > .05$ . Since the Tolerance values are more than 0.1 and VIF (Variance Inflation Factor) values less than 2, the multicollinearity issue is ruled out. Also, the discriminant validity test already cleared this assumption. Hence, the change of significance could only mean that GNH in Corporation as independent variable does not uniquely explain the relationship in the hierarchical multiple regression. Therefore, GNH in corporation as standalone predicts the employee performance although its significance diminishes in the multiple regression model. And, subsequently, the negative and insignificant result of GNH in corporation on outcome variable in the overall structural model can be assumed because it was posited as mediating variable where the influences from leadership, and to the psychological capital could have ultimately interfered and subjugated the relationship with employee performance. The coefficient table from the hierarchical regression model is presented in the following.

**Table 40 Hierarchical multiple regression model coefficients**

Model	Unstandardized Coefficients		Standardized Coefficients	t	p	Collinearity Statistics		
	B	Std. Error	Beta			Tolerance	VIF	
1	(Constant)	2.436	.199	12.214	.000			
	GNH	.376	.044	.352	8.486	.000	1.000	1.000
2	(Constant)	.898	.241	3.732	.000			
	GNH	.070	.051	.066	1.370	.171	.615	1.626
	Leadership	.125	.031	.179	4.057	.000	.724	1.381
	PsyCap	.492	.051	.410	9.612	.000	.777	1.288

a. Dependent Variable: Performance (Task and Contextual)

**7. Intervening variables: GNH in Corporation and Psychological Capital**

To test the mediation effect of the multiple mediators, ‘GNH in Corporation’ and ‘Psychological Capital’ on the relationship between Leadership and Performance, first, the parallel mediation test was conducted by including both the mediators in the same structural model. Since, there were no other probable mediating variables for the parallel mediation model, the ‘user defined estimands’ technology was unnecessary; user defined estimand function is used to restrict the influences from all other possible mediators by denoting with labels for specific mediators. The ‘Bootstrap technology’ with 95% confidence interval was used in fact. The low and high confidence intervals mentioned in the table are for indirect effects of mediating variables. Similarly, after the parallel mediation test, the intervening effects were examined separately for both the mediators.

**7.1 Parallel Mediation: Intervening effect of Multiple mediators**

The following parallel mediation model is used to analyse the mediation effect of GNH in corporation and employee Psychological Capital. This model is identical to the full structural model except that the relationship between GNH in Corporation and Psychological Capital is dropped to get accurate mediation result without its influence. However, this relationship is included in testing the serial mediation later.

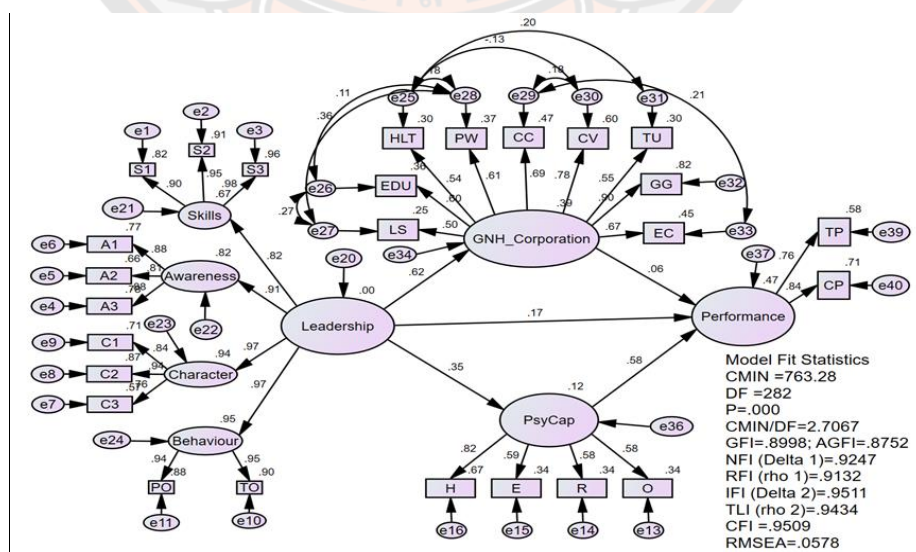

**Figure 15 Parallel Mediation Model**

The following table displays the result of influence of leadership on employee performance through GNH in Corporation and Psychological Capital as multiple mediators. It can be concluded that these mediators play a partial mediation. The conclusion is based on the parallel mediation test. The details of the result are explained based on the following table. The values presented in the table, which are bold, italicized and placed in a bracket are the standardized values. Both unstandardized and standardized values are mentioned for more clarity.

**Table 41 The intervening effect of multiple mediators**

Relationship	1TE	2DE	3IE	Confidence		p Value	Result
				Interval			
				Low	High		
Leadership-->							
GNH-->	0.155 (.407)	0.063	0.092	0.054	0.142	0.0029	4PM
PsyCaP-->		(.166)	(0.241)	(.107)	(.292)	(.0031)	
Performance							

- Note:**
1. TE=Total Effect
  2. DE=Direct Effect
  3. ID=Indirect Effect
  4. PM=Partial Mediation

To determine the significance of indirect effect of these multiple mediators, bootstrap estimate (Bias-Corrected percentile method) was set as reference. Since, the p value of two-tailed significance of Indirect Effects (both unstandardized and standardised) are significant with p values of 0.0029 and 0.0031 respectively, the effect was concluded as Partial Mediation on the relationship between Leadership and Performance. In the partial mediation model, the direct estimate value from GNH in Corporation to Performance stands at 0.166 (unstandardised value is 0.0632) with p value (0.0068) <0.05. The influence of Leadership and Performance was already significant. Hence the effect of mediating variables is partial mediation.



### 7.2 Separate Model 1: GNH as a Mediator

The model is concerned with the analysis of intervening effect of just GNH in Corporation as a lone mediator for Leadership and employee performance; the fit statistics are also presented as part of the analysis. Once the model-data fit is ascertained, the actual result is described. The model is presented as the following figure.

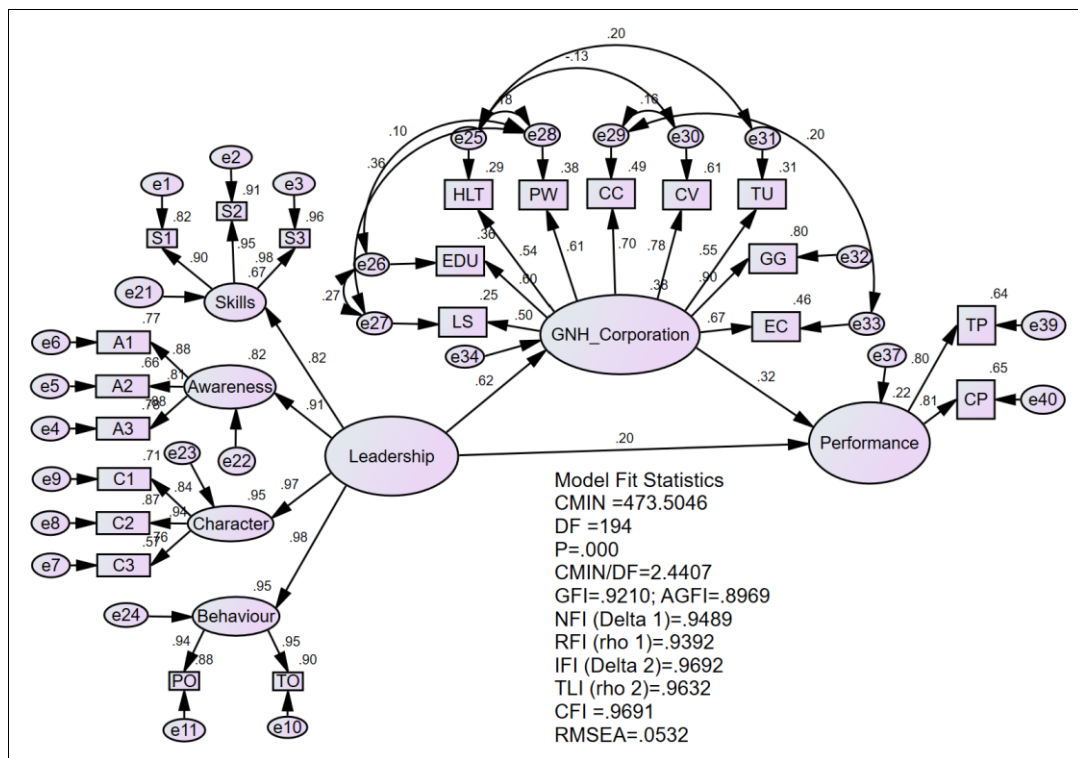

**Figure 16 Separate Mediation Model 1: GNH in Corporation as mediator**

The following table provides information pertaining to the status of relationships between pairs of variables. The relationships between Leadership and GNH in Corporation, and GNH in Corporation and Performance are significant at  $p < .005$ . This is a deviation from the overall full structural model, where it was observed that performance was not determined by GNH in corporation. In fact, they were noted to be inversely related. Well, getting back to the current separate model, the direct relationship between Leadership and Performance is also already significant with  $p$  value of 0.0016 (which is  $> .005$ ). Since, the direct relationship is statistically significant, the effect of mediator can only be considered partial mediation.

**Table 42 Estimates of relationships where GNH in corporation is a mediator**

Variable 2	<---	Variable 1	Estimate ( $\beta$ )	S.E.	C.R.	P
GNH	<---	Leadership	0.249 (.617)	0.027	9.186	***
Performance	<---	Leadership	0.081 (.202)	0.025	3.164	.0016
Performance	<---	GNH	0.316 (.319)	0.070	4.492	***

Considering the significance of indirect effect based on ‘bootstrap’ result, it is concluded that GNH in Corporation causes partial mediation; its indirect effect is significant with p value of 0.0032 (standardised value=.0027). The direct effect of Leadership on Performance is 0.081 (standardized=.202), and the total indirect effect of mediating variable is 0.079 (standardised=0.196). The total effect stands at 0.160 (standardised=0.398). The significance is established at 95% confidence interval. More information can be referred from the following table.

**Table 43 Intervening effect of GNH in Corporation**

Relationship	TE	DE	IE	Confidence Interval		p Value	Result
				Low	High		
Leadership--> GNH--> Performance	0.16 (.398)	0.081 (.202)	0.079 (0.196)	0.041 (0.109)	0.127 (.299)	0.0032 (.0027)	PM

### 7.3 Separate Model 2: Psychological Capital as Mediator

The next separate model is developed to estimate the mediation effect of Psychological Capital alone in the relationship of Leadership and Performance. The model satisfies the conditions of model fit statistics. The details are included in the figure.

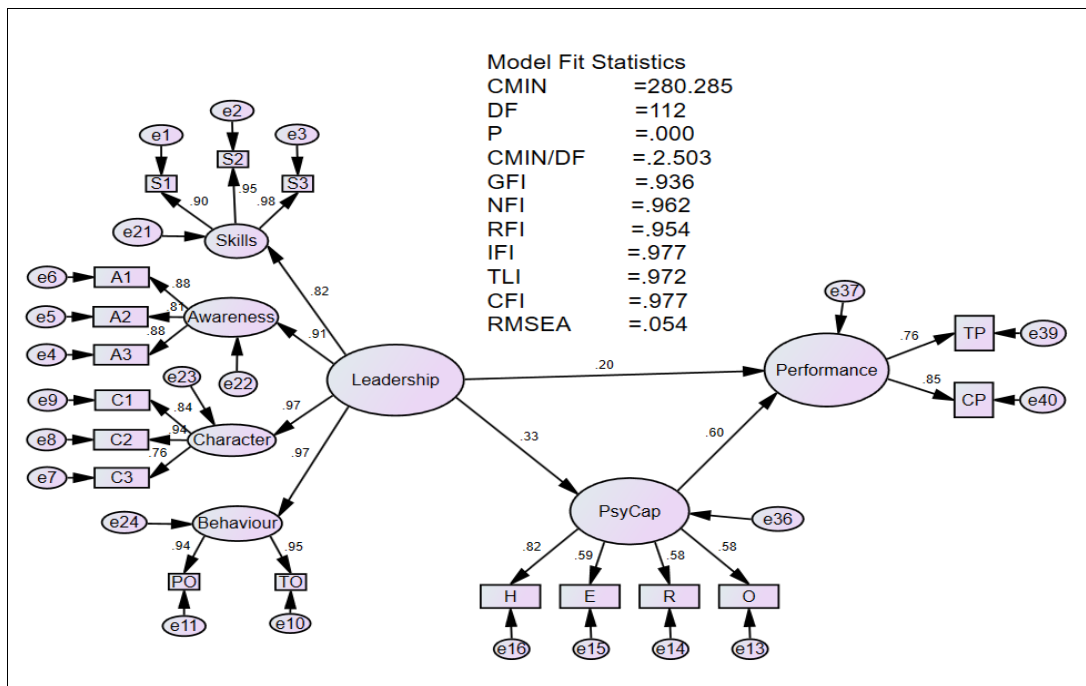

**Figure 17 Separate Mediation Model 2: Psychological Capital as mediator**

Based on this model, the influence of Leadership on Psychological Capital and Psychological Capital on Performance are both significant with  $p < .05$ . Also, the direct relationship between Leadership and Employee Performance is significant as well. At this point, it is also worthy to point out the differences again compared to the overall model. In the overall structural model where the path relations involve all the four constructs and five relationships, the effect of leadership on Psychological Capital was not only insignificant but negative. However, when the model is based only on these three variables, the estimates and the direction of influence of Leadership on Psychological Capital reverses, becoming both positive and significant. Refer the following table for more information.

**Table 44 Estimates of relationships where Psychological Capital is a mediator**

Variable 2	<---	Variable 1	Estimate ( $\beta$ )	S.E.	C.R.	P
PsyCap	<---	Leadership	0.126 (.334)	0.021	5.997	***
Performance	<---	Leadership	0.075 (.195)	0.018	4.08	***
Performance	<---	PsyCaP	0.607 (.601)	0.072	8.431	***

Since the indirect effect (IE) is significant with  $p < .05$  ( $p = .0035$ ; standardized = .0033), it can be interpreted that Psychological Capital partially mediate Leadership and Performance. The details are given in the table:

**Table 45 Intervening Effect of Psychological Capital**

Relationship	TE	DE	IE	Confidence		p Value	Result
				Interval			
				Low	High		
Leadership--> PsyCap--> Performance	0.152 (.396)	0.075 (.195)	0.077 (-.201)	0.051 (.136)	0.114 (.281)	0.0035 (.0033)	PM

#### 7.4 Serial Mediation

The serial mediation is tested to verify if the Leadership and Performance is mediated by sequence of GNH in Corporation and Psychological Capital as intervening variables. This mediation analysis is based on the customized model of the full structural model; the model is created so that the unnecessary influencing relationships are not accounted for. The model is displayed in the following figure followed by description of the output.

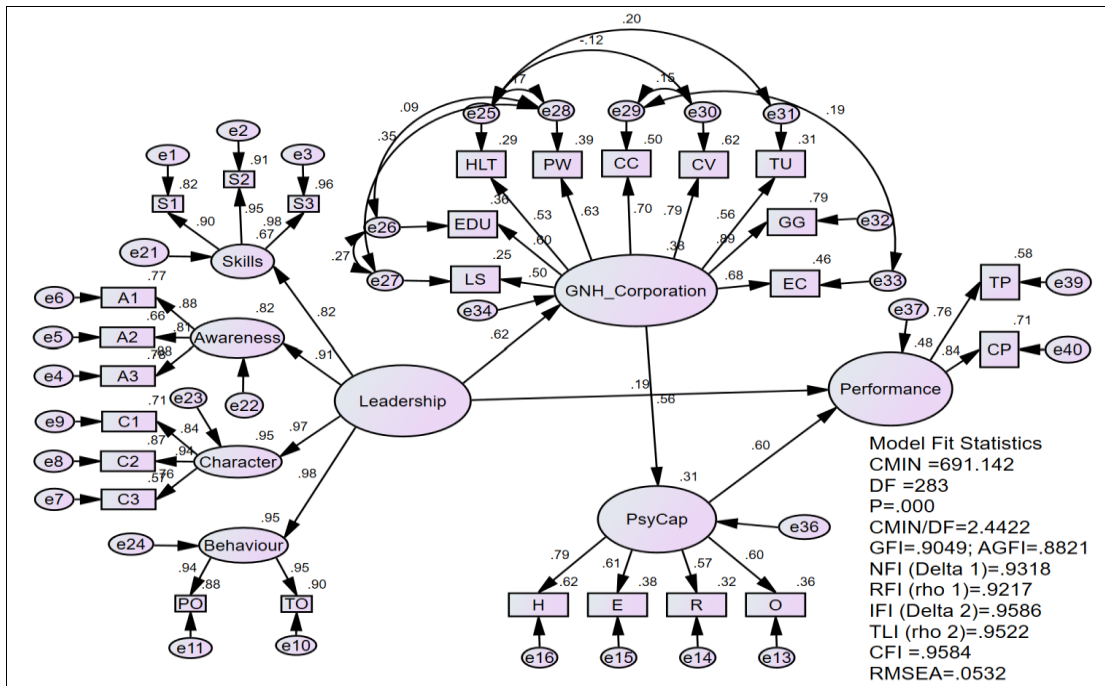

Figure 18 Serial Mediation Model

Table 46 Estimates of series of relationships

Variable 2	<---	Variable 1	Estimate ( $\beta$ )	S.E.	C.R.	P
GNH	<---	Leadership	0.2518 (.617)	0.03	9.240	***
PsyCap	<---	GNH	0.536 (.560)	0.07	7.626	***
Performance	<---	PsyCap	0.590 (.601)	0.07	8.571	***
Performance	<---	Leadership	0.073 (.190)	0.02	3.99	***

The analysis shows that all four pairs of relationships are significant. The Leadership in the corporation significantly determine GNH in Corporation and Employee Performance. Also, the influence of GNH in Corporation on Employee Psychological Capital is statistically Significant, while the later adjusts Employee Performance. The most important at this stage is the significance level of Leadership and employee performance, as this significance will be a reference point to conclude whether the two mediators have serial mediation. Thus, as it is known at this stage



that the direct relationship is significant, it can only be expected that mediation, if at all there is, can be partial mediation. The following table is presented to ascertain the result.

**Table 47 Serial Mediation Result**

Relationship	TE	DE	IE	Confidence		p Value	Result
				Interval			
				Low	High		
Leadership-->							
<sup>1</sup> GNH-->	0.153	0.073	0.08	0.058	0.115	0.0014	<b>PM</b>
<sup>2</sup> PsyCaP-->	(.398)	(.191)	(.207)	(.155)	(.274)	(.0013)	
Performance							

**Note:** 1. GNH=GNH in Corporation  
2. PsyCap=Psychological Capital

The analysis of serial mediation test shows that the total effect (TE) is 0.153 (0,0398) as a combination of direct (DE) and indirect effect (IE). The indirect effect of serial mediation is very significant with p value (0.0014; standardised=0.0013) <.05. This result is established with 95% confidence interval based on Biased-corrected percentile method.

### **8. Moderation Effect of Employee Personality**

The moderation of personality (moderator variable, MV) was first tested separately for the relationships between Leadership as an independent variable (IV) and Performance, GNH in Corporation, and Psychological Capital as dependent variables. One important reference for the moderation is the effect of 'Interaction' variable. For this reason, the independent and moderator variables were transformed as mean-centered. The 'Interaction variable' is thus formed as a product term from these mean-centered Leadership and mean-centered Personality variables. The outcome for each pair of relationships is analyzed based on the following models.

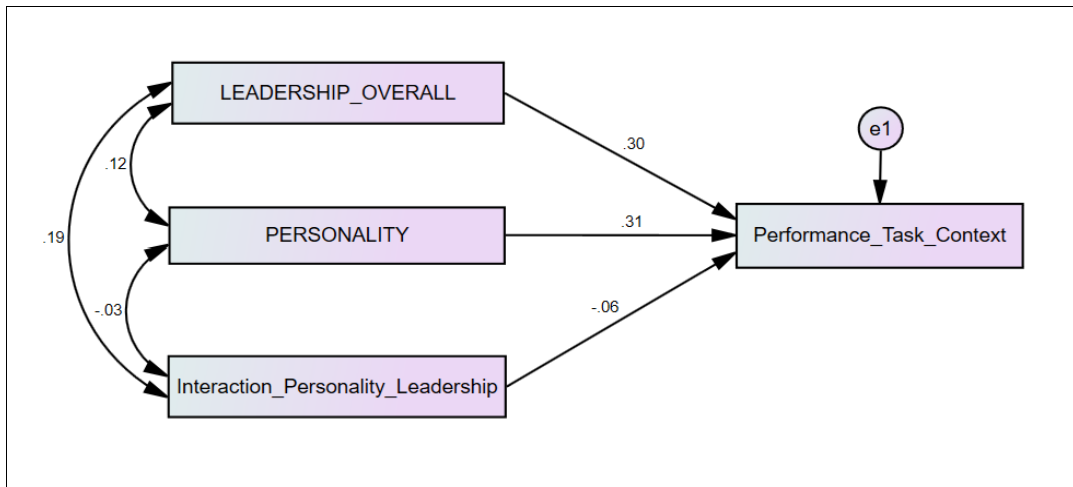

**Figure 19 Personality as moderator for Leadership and Performance**

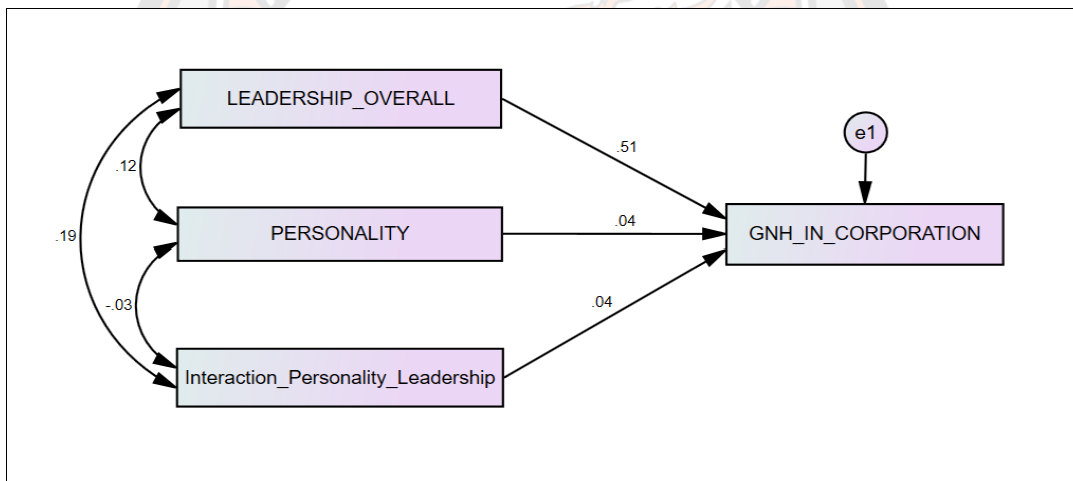

**Figure 20 Personality as moderator for Leadership and GNH in Corporation**

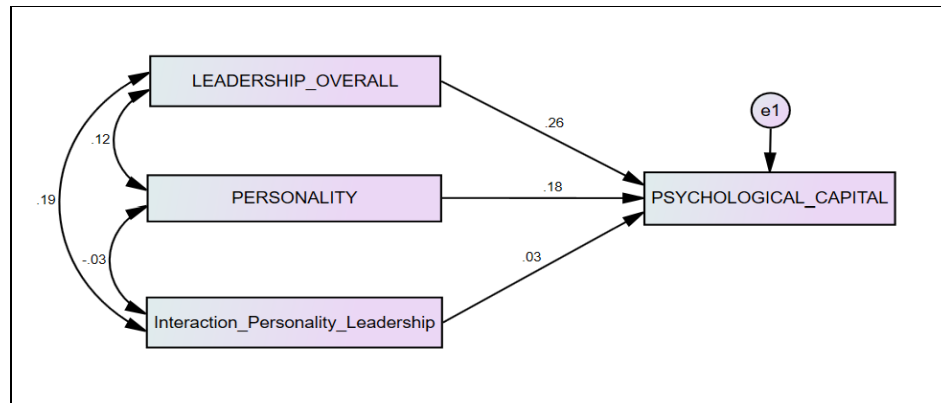

**Figure 21 Personality as Moderator for Leadership and Psychological Capital**

The Personality as a composite variable does not moderate in any of the specified relationships. In the case of relationship between Leadership and Performance, the interaction term is negative and insignificant at  $p(0.156) > 0.5$ . Similarly, personality neither moderate Leadership and GNH in Corporation nor Leadership and Psychological Capital. The  $p$  values of the interaction variable for these relationships stand at 0.245 and 0.453 respectively. The model fit has been investigated while the results were generated; all moderation models have achieved satisfactory incremental fit statistics. The details of the result are presented in the following table.

**Table 48 Moderation effect of Personality as composite variable**

DV	<---	IV/MV	$\beta$	S.E.	C.R.	P
Performance	<---	Leadership	0.212	0.028	7.527	***
Performance	<---	<b>Interaction</b>	-0.123	0.087	-1.419	<b>0.156</b>
Performance	<---	Personality	0.644	0.082	7.885	***
GNH in Corporation	<---	Leadership	0.333	0.025	13.183	***
GNH in Corporation	<---	<b>Interaction</b>	0.09	0.078	1.163	<b>0.245</b>
GNH in Corporation	<---	Personality	0.078	0.073	1.069	0.285
Psychological Capital	<---	Leadership	0.151	0.025	6.077	***
Psychological Capital	<---	<b>Interaction</b>	0.058	0.077	0.751	<b>0.453</b>
Psychological Capital	<---	Personality	0.307	0.072	4.262	***

Since Personality as composite variable was constructed based on the mean values of all items combined without breaking into personality traits, the result could be a little misguided, as personality could be simply understood to be high or low personality depending on low or high mean values does not really make sense without taking traits into account. So, testing moderation on relationships based on personality as composite variable could be a little flawed. As stated, without classifying based on traits, defining personality simply based on mean value does bear any meaning. For instance, as a composite variable, high mean value on extraversion could be equalised by high mean value in Neuroticism thereby neutralising other traits. So, to get comprehensive result, the moderation of personality traits on those identified relationships are tested. The results are presented in the following tables:

**Table 49 Personality traits on Leadership and GNH in Corporation**

DV	<---	IV/MV	$\beta$	S.E.	C.R.	P
<sup>1</sup> GNH	<---	Leadership	0.2972	0.0249	11.953	***
GNH	<---	Open_Mindedness	0.0672	0.0387	1.7357	0.083
GNH	<---	Conscientiousness	-0.0662	0.0335	-1.977	0.048
GNH	<---	Extraversion	0.03	0.0317	0.946	0.344
GNH	<---	Agreeableness	0.0904	0.0362	2.4944	0.013
GNH	<---	Neuroticism	-0.1841	0.031	-5.937	***
GNH	<---	O_Leadership_Interaction	0.0666	0.0427	1.5592	<b>0.119</b>
GNH	<---	C_Leadership_Interaction	0.0336	0.0396	0.8471	<b>0.397</b>
GNH	<---	E_Leadership_Interaction	0.0153	0.0341	0.4489	<b>0.654</b>
GNH	<---	A_Leadership_Interaction	-0.0201	0.0381	-0.529	<b>0.597</b>
GNH	<---	N_Leadership_Interaction	0.0253	0.0351	0.719	<b>0.472</b>

**Note:** 1. GNH='GNH in Corporation'; reflected simply as GNH to fit in the table

**Table 50 Personality traits on Leadership and Psychological Capital**

DV	<---	IV/MV	$\beta$	S.E.	C.R.	P
<sup>1</sup> PsyCap	<---	Leadership	0.1434	0.0257	5.5864	***
PsyCap	<---	Open-mindedness	0.0804	0.04	2.0124	0.0442
PsyCap	<---	Conscientiousness	0.0193	0.0346	0.5576	0.5771
PsyCap	<---	Extraversion	0.0878	0.0327	2.6812	0.0073
PsyCap	<---	Agreeableness	0.0749	0.0374	2.0017	0.0453
PsyCap	<---	Neuroticism	-0.0102	0.032	-0.3172	0.7511
PsyCap	<---	O_Leadership_Interaction	-0.0232	0.0441	-0.5263	<b>0.5987</b>
PsyCap	<---	C_Leadership_Interaction	0.065	0.0409	1.5887	<b>0.1121</b>
PsyCap	<---	E_Leadership_Interaction	0.0119	0.0352	0.3392	<b>0.7345</b>
PsyCap	<---	A_Leadership_Interaction	-0.0208	0.0393	-0.5307	<b>0.5956</b>
PsyCap	<---	N_Leadership_Interaction	0.0143	0.0363	0.3938	<b>0.6937</b>

**Note:** 1. PsyCap=Psychological Capital; PsyCap is used instead of Psychological Capital to adjust and fit in the table

Even when the moderation effect was tested at traits level, no personality traits moderate the relationship between Leadership and GNH in Corporation. Similarly, none of the personality traits moderate the influence of Leadership on Psychological Capital. These conclusions are based on the non-significant p values of any interaction variables. However, ‘Open-mindedness’ and ‘Neuroticism’ as personality traits were observed to moderate the relationship of Leadership and employee performance with interaction p values of 0.026 and 0.03 respectively as reflected in the following table. Since, at least two personality traits are found to moderate the relationship, the ‘moderation probing’ for these traits are conducted as confirmation tests.



**Table 51 Moderation of Personality traits between Leadership and Performance**

DV	<---	IV/MV	$\beta$	S.E.	C.R.	P
Performance	<---	Leadership	0.21	0.029	7.316	***
Performance	<---	Open_Mindedness	0.19	0.045	4.239	***
Performance	<---	<b>O_L_Interaction</b>	-0.11	0.049	-2.222	<b>0.026</b>
Performance	<---	Conscientiousness	0.084	0.039	2.181	0.029
Performance	<---	C_L_Interaction	0.023	0.046	0.507	0.612
Performance	<---	Extraversion	0.138	0.037	3.77	***
Performance	<---	E_L_Interaction	0.001	0.039	0.033	0.974
Performance	<---	Agreeableness	0.119	0.042	2.85	0.004
Performance	<---	A_L_Interaction	-0.035	0.044	-0.805	0.421
Performance	<---	Neuroticism	0.02	0.036	0.562	0.574
Performance	<---	<b>N_L_Interaction</b>	-0.088	0.041	-2.167	<b>0.03</b>

The interaction of ‘Open-mindedness’ and ‘Neuroticism’ traits of personality was probed further using ‘Pick-a-point approach’ or ‘Spotlight’ analysis. This method verifies whether the lower level and higher-level moderator change the relationship between independent and dependent variables. The lower and higher-level moderators for ‘Open-mindedness’ and ‘Neuroticism’ were transformed and created by adding and subtracting one standard deviation each to the mean of their original moderator. The mean values of original moderator were 3.591 (for Open-mindedness) and 2.634 (for Neuroticism) while standard deviations were 0.5666 and 0.7496. The interaction variable is again created as a product term of mean-centered lower/upper moderator and the mean-centered Leadership variable.

Although the significance of interactions for both the traits diminishes to 0.083 and 0.061; it is unimportant. In fact, the conclusion should be drawn from important references which are the estimate values ( $\beta$ ). The result from the ‘interaction probing’ indicate that higher Open-mindedness and higher Negative emotionality of employees weaken the influence of leadership on performance. The original beta/estimate ( $\beta$ ) value of leadership’s influence on performance in presence of personality was 0.212. When open-mindedness is placed as higher and lower-level moderators, the estimate changes to 0.18 and 0.27 respectively. Similarly,

Neuroticism as the higher and lower-level moderators result in estimate values of 0.176 and 0.277. The statistics are presented in the following table.

**Table 52 Result of Moderation Probing of Open-mindedness and Neuroticism**

DV	<---	IV/MV	$\beta$	S.E.	C.R.	P
Performance	<---	Leadership	<b>0.18</b>	0.035	5.204	***
Performance	<---	O_Interaction_High	-0.079	0.046	-1.733	<b>0.083</b>
Performance	<---	Openess_High	0.277	0.043	6.479	***
Performance	<---	Leadership	<b>0.27</b>	0.042	6.37	***
Performance	<---	O_Interaction_Low	-0.079	0.046	-1.733	<b>0.083</b>
Performance	<---	Openess_Low	0.277	0.043	6.479	***
Performance	<---	Leadership	<b>0.176</b>	0.038	4.579	***
Performance	<---	N_Interaction_High	-0.067	0.036	-1.87	<b>0.061</b>
Performance	<---	Neuro_High	-0.087	0.034	-2.598	0.009
Performance	<---	Leadership	<b>0.277</b>	0.041	6.721	***
Performance	<---	N_Interaction_Low	-0.067	0.036	-1.87	<b>0.061</b>
Performance	<---	Neuro_Low	-0.087	0.034	-2.598	0.009

## 9. Summary of Quantitative Findings

The Leadership of Corporations play very crucial role. It was found through statistical analyses in this research study that Leadership significantly determines Employee Performance and the GNH in Corporation. Even though Leadership does not seem to enhance employee psychological capital significantly in the full structural model, the relationship when examined as standalone, leadership in fact makes sense for the Employee Psychological Capital. Similarly, when put in the overall Structural model, the relationship between GNH in Corporation and Employee Performance is not only negative but also insignificant. However, when examined the relationship involving just two variables as independent and dependent, employee performance is influenced significantly by the GNH in Corporation. This discrepancy could be attributed to the strong relationship between GNH in Corporation and Psychological Capital resulting in negative and insignificant relationship between Leadership and Psychological capital, and GNH in Corporation and Employee Performance. The intervening role of GNH in Corporation and Psychological Capital

on Leadership and Employee Performance was tested using parallel mediation model as well as through an individual mediator model and serial mediation model. All mediation tests show they are responsible of partial mediation. The moderation effect of employee personality on Leadership and Performance, Leadership and GNH in Corporation, and Leadership and Psychological Capital was also analyzed. The results reveal that personality as composite variable does not moderate any of the relationships. However, when moderation was analyzed at traits level, ‘Open-mindedness’ and ‘Neuroticism’ tend to weaken the relationship between Leadership and Performance. The main findings are summarized in the following table:

**Table 53 Summary of hypothesis test outcome**

<i>Hypothesis</i>	Variable			<b>p</b>	<b>Result</b>
	<b>Independent</b>	<b>Mediator/Moderator</b>	<b>Dependent</b>		
<i>H1</i>	Leadership		Performance	.000	<b>Accepted</b>
<i>H2a</i>	Leadership		GNH	.000	<b>Accepted</b>
<i>H2b</i>	<sup>1</sup> GNH		Performance	.000	<sup>2</sup> <b>Accepted</b>
<i>H3a</i>	Leadership		PsyCap	.000	<sup>3</sup> <b>Accepted</b>
<i>H3b</i>	<sup>4</sup> PsyCaP		Performance	.000	<b>Accepted</b>
<i>H4</i>	GNH		PsyCaP	.000	<b>Accepted</b>
<i>Primary Hypothesis</i>	Leadership	GNH & PsyCap	Performance	.0013	<sup>5</sup> <b>Accepted</b>
	Leadership	Personality	Performance	.156	<sup>6</sup> <b>Rejected</b>
<i>H5</i>	Leadership	Open- mindedness	Performance	.026	
	Leadership	Neuroticism	Performance	.03	
<i>H6</i>	Leadership	Personality	GNH	.245	<b>Rejected</b>
<i>H7</i>	Leadership	Personality	PsyCap	0.453	<b>Rejected</b>

- Note:**
1. GNH=GNH in Corporation
  2. In an array of influences in the overall model, the GNH in Corporation does not influence performance; however, there is significant influence when their relationship is tested without considering other variables; the result is indicated in the table.
  3. Although Psychological Capital is not determined by Leadership in the overall SEM, the later actually influence significantly when examined their specific relationship separately.

4. PsyCap=Psychological Capital
5. The result of this hypothesis is based on the serial mediation test.
6. Although personality as a composite variable does not mediate the relationship, the 'Open- mindednesses and 'Neuroticism' moderate the relationship of Leadership and Performance

### **Deconstruction of Interview Data**

In addition to the data collected through survey questionnaire from general employees, the interviews were also conducted with the authority concerned of the Human Resources and Administration Department/Division of the Corporations. However, it is important to clarify that the choice of interview as one of the sources of data was not to contest employee's opinions in any way, but the interviewees were found to be more appropriate considering their connections with employees who better understand them. Their views were personal. Thus, the information generated from interview is used rather as a support in analysing and discussing the result from the survey data. Prior to the interview, the participants were briefed on the content of NUIRB\* form AF04-10/5.0 (Information sheet for Research Participant-Interview). (\*NUIRB=Naresuan University Institutional Review Board). It pertains to the research ethics; they were informed about the research background and objectives, participant's rights and responsibilities, risks and benefits, and the promise of researcher on maintaining confidentiality of respondents. With their due consent, the interviews were recorded as audio-data. In the analysis of interview data, for the sake of confidentiality, more clarity and in repeat quotations, participants were identified as P1, P2, P3, P4, P5, P6 and P7 instead of their real identity.

Seven interviews, one from each of the identified corporations were conducted. Almost all the interviewees were senior and seasoned officials with varieties of experiences. While some have experiences of working in both civil service and other corporate offices in past, some have been employed in the same organisation for many years. In terms of the number of work experiences, it ranges from eight to 20 years. And it is noteworthy to state that all interviewees were male.

### **1. Interpretation of GNH in Corporation**

The participants were asked to share their interpretation of GNH in corporation. The objective was not intended to test participants on theoretical understanding of the GNH concepts but to get the first-hand experiential input from the leaders and managers who have certain degree of influence on the policy matters of corporations. While participants generally have inherent feeling that the concept of GNH at fundamental level, be it in government agencies, business corporations or other organisations such as in NGOs should be same, they however believe that the extent of emphasis and application of certain domains could be varied. The interpretation of GNH in corporation based on the interviews is presented in line with the prominent themes of purposive economic development, good governance, concern for ecology and environment, welfare and happiness, and ‘money-still-matters’.

The GNH in corporation is being interpreted as a comparison between government and non-governmental organisations in terms of the very purpose of existence. There may be a hint that GNH or happiness in organisations should not be a matter of leniency, bureaucracy, misplaced compassion, or irrational considerations. Usually, the civil service sector specifically has been in focus for so long, for wrong reasons such as being bureaucratic, complacent, ineffective, or so in public service delivery; the current ongoing transformation exercise is only befitting. On the other hand, civil servants so far are believed to have the most secured employment whereby they derive satisfaction and happiness. One of the interviewees who once was in civil service stated that “so, what you notice is, in the civil service, to be very honest, people really don’t care much. That’s why, His Majesty himself had to intervene. They deserve it. I can say that very bluntly. In civil service, there is complacency anyway. That’s for sure”. Such compelling comparisons are also noted through interviews while GNH as a topic is probed. To set the context, the following excerpts of the participant P2 are mentioned:

...So, the moment you say, is a corporation versus civil service, for that matter, social organizations, like ministries, so, you know the purposes of their existence are totally different. So, we have to understand that company exists for a purpose, unless it is NGO or unless it is social service



organization, the extent of existence of the concepts and values may differ but then I think, that does not mean that corporations do not exactly apply GNH concepts.

We need to see, and especially in changing times and, same incidences in civil service, managing out, reforms, transformation, now, do we really want to understand GNH concept in the different manner or do we want to really change the perception or understanding of the GNH concepts. So, there is a little discrepancy.

P7 expressed that “when it comes to corporation, I do not mean we do not have GNH; as it is government owned corporation, it is anyway based on the GNH policy drained down from the top”. This statement underscores the purpose of organizations as the basis of interpretation. Although participants do not elaborate the purposes of government ministries, agencies, or non-governmental organisations, they tend to imply that corporations, unlike government or non-governmental establishments, are distinctively laid on the foundation of money making as its core purpose. And this purposiveness of the corporations leads to the next interpretation of GNH in corporation as contributing for economic development. This pertains to the activity of commercialization and profit making for the nation. This point comes out very clear and loud from almost all the interviewees. For instance, P2 confidently and with pride states that:

...And how do you bring happiness in people is, okay, maybe we can say, we can bring profit and that profit is supposed to go back to national exchequer, and from there, it is supposed to cater to the needs of the general mass. So, from corporate viewpoint, probably, we can say that it is not direct GNH, but it happens to be indirect. we are supposed to enhance the revenue and with that revenue we are supposed to improve our GNH status. So, you improve whatever development programs that, ministries have to do, government has to do, has to come all through money. So, ours would be basically GNH through revenue.

The same message is being echoed by other participants. The following are excerpts expressed by other participants in the context of economic development:

...GNH in corporations, when we look at pillars, economic development is one of the components, economic development, in here, DHI and subsidiary companies would make a huge impact, I think. Especially towards that [economic development]. As we are money making company, at the end what matters is the contribution of revenue and the dividend to the government. Because this matter, may be focus may be more on money making. Since we need to submit to the government. May be slightly more focus on commercialization; seems we focus a little more on money making

(P1)

...And then, if we see from one side, government also need money, government needs to depend on the corporation, and them, so, from the management point of view, our happiness is how we are able to contribute to the government; whatever we earn, finally we have to submit to the government. Government finally, the shareholders are the all the people of Bhutan, so, are we able to help the people of Bhutan; need to see from this side as well.

(P4)

...But, by and by, there could be other elements but directly trying to talk in terms of business, I think, business, ours is to make revenue, good in earnings, that is supposed to plough back to the government for social benefits which is happening

(P5)

Another distinctive theme derived was the good governance as integral part of GNH in corporation. The participant 5 states that:

...One is, in GNH there is good governance. Right? Equity before the laws, pillars etc. These, when it comes to good governance, what comes into me is, transparency, accountability, then doing business ethically, not cheating, not profiting too much, good governance, what are the practices of good governance put in place; that would matter a lot in order to achieve, in order to gear towards GNH.

There is also a general belief that corporations should be concerned about the ecology and environment. In fact, environmental protection is one of the four pillars which define GNH. According to P5, “if we look at environment point of view, we have to be environment sensitive. Don’t waste resources, consume less resources as possible, then follow competent environmental rules, and how aware we are in GNH, Companies like ours”. Despite the unanimous consensus on the importance of environmental conservation, promoting environment perse could be conceived to be contradictory as one of the participants has expressed as mentioned here:

...When it is business, a little effect on environment is there. Right? For example, if we set up a factory, but, factories, I think we should see how we can reduce the impact on the environment. Actually, if we have to, how our factory can promote the environment, then, its contradictory. So, our majority contribution would be mostly on economic fronts.

(P1)

There are a few participants who opined that GNH may not make sense in corporations. For this context, an excerpt from P3 is presented in the following:

...In my view, the GNH cannot provide much help to companies as companies should be there to make a profit. Even as a country, if GNH principles are given too much importance, then the development of the companies will be impacted. If every country takes care of the conservation, especially ecological/ environmental then there won’t be issues but only a handful of a country preserving the environment will have minimal impact

on the total environment and the development of the countries preserving the environment will be impacted.

The GNH incorporation is also simply interpreted as welfare and happiness in the organization as P6 describes “in my understanding, GNH is simple, main is the happiness; in corporation, [it is] how we take and implement GNH or how we are happy”. The participant also said “whether it is in corporation or elsewhere, peace, the working environment of the staff should be peace[peaceful]. When there is peace, it encourages them to contribute into growth of company, and to fulfil the goals and, vision and missions”. Similarly, P2 also expressed “let’s take, for example, from the viewpoint of HRD, we won’t want to have excessive output, or products, whereby, we also don’t compromise employee welfare, agility, agile environment. So, we have to balance. Even if it is corporation, there is purpose, and ultimately what it matters is really transit into happiness”. However, GNH is at times being understood as philosophical which could be applicable only for those who are into the spiritual path and meditation. In this line, P4 states that:

...Basically, when we discuss about GNH, it is very, some say, philosophical topic to be discussed. And then, practically, whether GNH is applied, the concept seems to be theory and not really applicable, then when it is GNH, like, you should be happy with whatever you have and then, you do not compare, then you don’t become materialistic, or we are talking basically such things. But then, if you check practically, people’s happiness at highest level, I think, someone who meditate and follows spiritual path enjoy GNH fully. Because, for them, they do not have any needs, then if you talk purely, it is going from religious point, I think. Those who are in the mountains meditating, I think, for them, [GNH] is fully applicable.

And there is strong indication that money still matters. It was very clear that money plays the important role. For instance, from the discussion over employees leaving the job, interviewees expressed that most leave the organization for Australia seeing the good future. The participant P5 stated:

...Yes, there are instances where our employees left for Australia. It keeps happening. I think no matter how much we try, money they see over there outweighs the benefits from the company. People say, at the end 'even if we work for whole life, I cannot even let graduate my son and daughter [children] if they don't qualify for the government scholarship. There are no instances where people share grievances saying that 'I don't want to work here' but no matter how we try to keep them motivated, benefit out there [in Australia] is much higher than working here, I think. Of course, I do not have personal experiences. But that's what I hear.

Similarly, according to P4

...in our society, where one has family, of course, we say, we don't measure GDP but measure GNH. However, practically, these days, people look for money only. Whatever, like, whether it is to send a child for study, it is through money; to construct a building, it is money, to stay comfortable in towns, money matters.

And some participants feel that the term GNH is being used everywhere to the extent that it can be a deterrent factor itself as P2 states:

...So, we all know, whatever we do, its GNH, GNH and GNH. At the same time, it is also acting as deterrent factor to our development. We need to see, and especially in changing times and, same incidences in civil service, managing out, reforms, transformation, now, do we really want to understand GNH concept in the different manner or do we want to really change the perception or understanding of the GNH concepts. So, there is a little discrepancy.

Similarly, interviewee P7 also states that "GNH, in my personal opinion, as also pointed out, these days everyone says GNH and GNH. Whatever it may be, at the end, we need to have outcome. To me, many talk about GNH but in practice, it's



doubtful if what we talk matches what we do.” And another noteworthy statement from P3 is “since I was fully involved with the GNH Certification for my \*organisation last year, (\*The name of specific corporation is replaced with my organization for confidentiality of the participant.). I will go with the GNH for Business Concept. But then to elaborate on the GNH for Business concept here would be a total waste of time for you as well as me”. The reluctance to share opinions on GNH related topic indicate two mentalities, one could be to imply that the current research is not worthy of much discussion, and another may be to signify the saturation of expressing ideas pertaining to GNH.

## **2. Bhutanese Corporations and application of GNH**

The next, interviewees were asked to share about their impression on Bhutanese corporations and what can corporations do to promote GNH, especially in the socio-cultural and ecological fronts. Although, money making was the main motive for corporations, there is more than just profit. The participant P1 mentions that:

...If asked whether we apply principles [of GNH] in the business, to the extent possible, we try to align the principles and, starting from philosophies down to the principles. For example, if I give you an example, if it is a new company coming up and has a huge, we see that as having a huge impact on environment or something like that, we might not even pursue that kind of project. Doing that, we are aligning, I think. By being (inaudible, may be ‘mindful’) of principles of GNH, we are not initiating that kind of project.

We do not do, make money at the cost of other principles, of other pillars. If the [idea associated with] money making/profit is observed to be detrimental, we even drop the idea. I think, GNH is applied pretty much but with more focus towards commercialization.

And interviewee P2 exerts:

...There is lot to do in corporation. Not to be too much profit oriented, not to be too much profit centered but also you should be the people centered and culture, tradition centered. But not to the extent of overwhelming and compromising or undermining the company's output, economic productivity, but I think, Corporates have to do. Not much has been done, I feel, on that front.

This is a clear indication that corporations can improve their focus for more balanced outlook, in terms of profit and other GNH parameters. The parameters as identified through interviews include ecology and environment, good governance and professionalism, socio-culture, and fair economic distribution.

In general, as mentioned earlier, corporations seem to be more mindful and focused on their contributions towards government in the form of profit or dividend. The major applications seem to be in the economic development and fair distribution of dividend throughout the country. This is clearly reflected, for instance, in the statement of participant P1:

...Economic is straight forward, especially the DHI companies. In economic development side, what we contribute towards government is being spent on the economic development of the country. Right? So, its straight forward. More we make, the better it is, so that the government can distribute it to the rest of the people in the form of development. Right? Whether it is road or bridge construction, money is essential. So, the more we make, the more we contribute towards government as a dividend, the better it is. So, in the economic side, all of our companies and even the [inaudible] collectively, make money (earn profit) and submit [to the government] is important. So, the involvement how we contribute is straightforward.

This contribution is the usual arrangement and only expected of the corporations as per their objectives and mission. However, the interesting point is that corporations support the government in times of difficult times as well. For example, corporations sacrificed their 2020 annual bonus and contributed to the government exchequer. This is clearly found in the statement “in terms of government’s four pillars, I think we are able to contribute, in the GDP more; if we check and compare this year with last year, in corporation, we also give bonus; so, we have also contributed bonus to the government, as government is in short of money [due to covid] (P2). The corporations such as NRDCL [Natural Resources Development Corporation Limited] also makes sure that the essential resources are distributed fairly across the country. The prices of the natural resources are said to have capped for equality.

Another application of GNH is in the form of continuous strengthening of corporate governance. All corporations are of view that they focus on good governance as well. They are confident that the corporate governance is not only for the DHI corporations themselves but one which can set as an example and be looked up on by other corporations and private companies. While the DHI is solely responsible for initiating, monitoring, and implementing corporate governance, participants from other corporations agree that they have system in place for the good corporate governance. Just to contextualize, the participant P5 states that:

...When it comes to good governance, DHI has been really promoting the good governance in its companies. We have codes and manuals that we have to follow. Those things are taken care as everybody has to follow. Accountability by, sometimes, through compact signing, how you rate it, what are the components within there in compact, we have all these towards the good governance.

And in line with good governance and professionalism, one participant explains that there is no room for ‘misplaced compassion’. This phrase ‘misplaced compassion’ is interestingly noteworthy because, GNH is most often misunderstood. The term is simply understood sometime by some as unconditional happiness at face

value. For instance, employees being happy that no one monitors for being late to work or being paid full salary even if one is ineffective may be interpreted as GNH; or put simply, short term individual happiness because of lack of professionalism, accountability, transparency. GNH is not about short-sighted individualized happiness without limit and boundary but collective aspiration for better civilized society. The participant states:

...So, what I am trying to say here is, from 2008 on, compact, targets, accountability, good governance have come out and become clear. And we talk more about responsibility and accountability. So, because of these, we are bound to perform. And your performance management, each and every employee has to sign target, what you want to do for the year, so, it is very clear. Now you can't, and then you talk about the revenue, when we talk about revenue, we really need to cut down the cost and when you think of cutting the cost, we need to think of efficiency, when we think of efficiency, we need to think about the services. So, we don't want to, we can't afford to have people without work, we can't afford to have people without enough work. Can you tolerate, what I am saying is, see, why I say 'misplaced compassion' is, if I pity that person, if I pardon that person, now what's going to happen? I am not paying her salary; the salary is paid by the company. So, if try to pardon her and really excuse her, you are not being sincere to yourself; you are trying to consider her at the cost of the company; it's not from your pocket of course. But then still we don't want to remove but as HR officer, we try to also correct them, through all these administrative measures or through personal interventions like advice, counseling, we have to do these. And then, even if this does not help, then we have to go for course like 'rehab'. Because, as a human being, that's why the whole thing, because to fire [terminate] is simple. The moment you have gathered lot of information against that person, you can fire them, but then ultimately where do these people go again? They go to society, and society where we have high, you know, welfare programmes, which is going to cost the nation ultimately. So, we try to think that we should take the

responsibility of trying to correct them. And if this doesn't help, then, YES! Because if it continues, not sustainable, because, it is not that we are dealing with one or two people; we are dealing with hundreds and thousands, so, may be if I keep on pardoning her, that will have ripple impact on the other people. So that should act, our action should act as deterrence to other people who can behaviorally get into the behavioural problems. That is what I mean actually.

In terms of Socio-cultural development, participants are of view that corporations are taking part at its best. It is conclusive that corporations are involved in CSR activities and in public welfare donations. Donations are provided, for instance, in the renovation of old community temples, providing stationaries and essential equipment to needy schools in remote areas, supporting sport facilities, and providing gainful employment for enhancement of national workforce. These contributions are reflected in the following interview excerpts:

...We have certain fund for CSR, may be, usually, the CSR fund is not given to one person, but most goes out in the form of donation. Example, if a school in a remote location is in a pathetic condition, and required development, then we might want to contribute. And if a community requires Lhaxhang (temple) renovation (Nyamsor Zhu ni), there we might contribute. Then, if it is a contribution towards some society like cancer, then we might contribute. So, we have such contributions, here and there. Not really big amount but wherever required, we keep aside certain funds where we contribute towards community or society in the form of donations or Corporate Social Responsibility.

(P1)

...So, again, on the community development, this is need based. If the community requests, then we give. ...we believe in deities, we are superstitious, and then all our dams and hydropower, you know, process, whole chain is in the rivers, gorges, underground, and hence, so we really



have to invoke all these. So, for us, these use to be regular events. Even, they keep budget. Its annual event, especially, Tshechu, Riwo Sangchoe, Drupchen etc. And office rimdro is common.

(P2)

...I think, we have, Corporate Social Responsibility (CSR); for example, we contributed for basketball court, tennis court or so\*; and then we also sponsor desktops, and contributes laptops etc., in schools, and then some small things here and there, we do, of course even if we want to do more, there is delegation of power. For DHI companies, maximum we can go for particular CSR is just 25000. We cannot cross this ceiling.

(\*The specific place where sport contribution was made is removed for confidentiality of interviewee.)

(P4)

...In such occasions \*[Foundation Day, Royal Wedding, etc], our staff and employees are required to organize and showcase cultural programmes, division wise, we have to perform cultural programmes. When employees are given opportunities, employees come up with different cultural items including dress codes, different songs, they show all these after having thorough research. And, we also see some of our other companies sponsoring shows such as 'Druk Super Star'. I think all these support culture.

(\*For maintaining confidentiality specific name of event was changed into generic)

(P6)

...in our organization, we make sure, of course, we cannot make, we cannot use national language for all correspondences, but for basic office orders like recruitment, promotion, transfer, we use 'Dzongkha'[national language]. And then for all the national events, you know, national events, functions, we also make sure that we have all these elements, like, for example, on the national occasions like Birth Day [Royal Birth Anniversary],

National Day, we make sure that we organize small functions to show our deep respect to the monarchs, for that matter, to the nation.

(P2)

...Again, when it comes to social and cultural, one prominent social issue is unemployment. Even in such issue of unemployment, we can play a big part, to generate more meaningful employment. Right? Even in this, we can play a big part, I think.

(P1)

...It is true that, the bridges and road construction are purely done by our Bhutanese; we don't engage labourers from India. Then, in terms of the 'tunnelling', since we have not taken part [in such tasks] so far, and even if it means a loss, socially, for the development of national workforce, as per the command of our Board and DHI, we have been taking up the [tunneling] task. For, especially for bridge and roads that the we take as projects, we would not need any workforce from outside.

(P7)

There is also an indication that corporations are participative in environmental conservation activities. For instance, P6 states that his corporation in collaboration with other corporations sometimes take initiatives such as tree plantation programme. This statement is agreed by other interviewees. The participant P5 expressed that "of course, for us, we as company is [are] very much involved in environmental conservation. Though our activities looks like we don't, like, seems we are not into such [environmental conservation] but we actually do [conservation]. We have plantation programmes, mitigation programme, wherever we work".

These are but the evidence of applications of GNH at corporate level. And participants on asking whether they implement at their personal level as leaders themselves, all expressed unanimous 'yes'. The following are the answers garnered how they apply at their level. Basically, their initiatives seem to be intertwined with both in the form of their official roles and as an individual. All participants agree that

they are responsible for ensuring employee welfare by providing necessary facilities, especially if employees had to be placed in remote areas, example in project sites; in general, making sure of conducive work environment has been identified as their immediate application of GNH although it is not unique from what every HR official usually does. The following are some relevant excerpts that participants focus as an official:

...If it is for HR, we will have to look at welfare of employees, what facilities they shall get, some people are posted in remote areas, some posted in good facility areas, areas where there is good communication, good schooling, living, and there are places where people really suffer, if we look at their work field. So, it is our duty to really look at the welfare of our staff, their working conditions, how to improve the working conditions, then how to provide facilities so that happiness is promoted.

But when we say, one of the leaders, I am one of the management team here, as I said, we don't apply in day-to-day basis thinking about GNH, but some of the works that we do have, will, does promote GNH.

(P5)

The other initiatives include working towards achieving the bigger holistic aspiration of having better national human capacities, and in helping to preserve cultural and traditional values.

...So, I as an HR \*official, for that matter, I as senior official or senior citizen, we also believe in trying to build in human resources. That only in terms of activity, but I as the HR official, my focus is also to make, our people are highly, you know, educated, highly knowledgeable about the country's cultural and traditional values. For example, as HR, we have to impart to our employees not only the technical skills, we also have to impart skills, knowledge on your[our] values. Now, how do you really embody all these? So, my point is, in other words in our set up, in our organizations, we have strong good governance systems, which means to really say how you

really try to ensure your responsibility, accountability, check and balance, and efficiency.

(\* The actual designation was replaced by HR official for the sake of maintaining participant confidentiality)

(P2)

However, there are other personal level initiative such as being down to earth and approachable by subordinates. In fact, this kind of character customization represents individual adjustment. This may be inconstant and variable depending on personality and nature of persons though.

...One initiative I try is power distance. I mean, the distance you create to your subordinates. So, like, in some case, employees cannot approach, which means, the boss is trying to maintain boundary, distance [inaudible], then you don't mingle with them, no socialization, these do happen. So, in some companies like in Japan, its due to culture, power distance is very heavy. But, in our case here, it's a mix, so, I am trying to make sure that there is no power distance; interact, go to them, visit everybody, talk to them, call them and seek information. I try to reduce the power distance. This is what I mean. And, one is, like, I go with them [employees], like one night trip away; and sometimes we do 'gathering' [get-together sessions], and you learn a lot of things informally. If you try to make everything formal, you will not get, understand 100 percent of what employees' expectations are. So, most of the important information we require comes informally; you relax over a cup of drinks, go trekking, go for outing together; so, these are what I am trying to do, from my side.

(P4)

The interviewees were also asked whether they are aware of the GNH certification process. This topic was just part of probing question and was not initially part of the interview question. Majority of the participants were not sure about the certification process and the parameters used for certifying corporations. Overall,

among the seven participants, they are least aware of GNH certification; may be certification process is at its early stage. The participants stated the following regarding the GNH certification:

...I have heard about GNH Certification. But I am not very aware of the details inside that survey. Not sure what's in it. Parameters and evaluation. Not really aware of details inside. Of course, heard that couple of corporations have been GNH certified.

(P1)

...Honestly, we also heard about some companies being certified in BBS [Bhutan Broadcasting Service] only. We have no idea, how it is done, what are the basis, maybe they visit offices, meet top leaders and rated. We have not observed any [third party] visiting the general offices. We have also heard only when BBS announced last time; Indeed, there was an award and certification, but I am not sure about the basis. That's why we are not aware of our status. We have no idea how it is evaluated. Not sure whether they visit company to company formally or observed informally, whether feedbacks are collected from customers, we don't know.

(P7)

...[On GNH certification]-have not done so far. No such practice in place. If they have such good practice we can also implement. But we have, never thought of handling intentionally. May be the first target [for GNH certification] is those profit-making companies. In our case, we sustain ourselves; we don't have big profit at the end of the year.

(P5)

The participants pointed out that certain things can be improved. For instance, some of the participants feel that the usage of Dzongkha [national language] especially for official correspondence could be enhanced. Only a few corporations, such as Bank of Bhutan was observed to be using national language for their annual



report. The other areas of enhancement could be in the cultural and traditional fronts in times of globalization and influence of westernization. The following are excerpts in this this context:

...I feel, as a Bhutanese, I feel that we should do more how we can repel or resist or withstand the cultural imperialism or we call it globalization impact. Because the way youth perceive, way youth look at things, are very, you know, we are so much influenced by globalization and we have very limited resources in terms of employment, in terms of resources; so how can Bhutan really cope with these pressures and I thought, probably, only thing we can do is of course, we can try to optimize your revenue through optimization, enhancement of whatever, through trying to explore other market, export kind of avenues, but equally important also, parents, teachers, community as a whole, we really have to inculcate all those values how to live simple life, I feel.

(P2)

...\*And, when I think of the socio-culture, in corporations, our national language, its importance is being stressed either by government or Dzongkha Development Commission, but, main, one important in the GNH is, preservation of language under cultural preservation, I think. I don't see this being implemented in our corporations; I am not aware of other; I have only observed in BOB [Bank of Bhutan] where Dzongkha is being implemented; even their annual report was in Dzongkha; likewise, I have not observed [Dzongkha] being implemented in other corporations. We think of implementing, but it does not work; it [order] should come from DHI, where it is included in yearly compact; only if there is some sort of intervention where the official language should be in Dzongkha, only then I think, it may be implemented. Of course, we have challenge, but it is not okay to neglect thinking of challenge. So, sir could reflect this under cultural preservation, as [requirement] in DHI corporations. I feel we need to focus our national

language more in corporations. (\*A few sentences from this excerpt have been removed to protect the confidentiality of participant.)

(P6)

### 3. Leadership in Bhutanese Corporations

The picture of leadership in Bhutanese corporations do not seem to be encouraging or exemplary. In this interview, unlike in survey questionnaire, where subordinates rated their supervisor or leader, the participants were themselves leaders, at least in terms of position in their organizations. Hence, their perspective on leadership in Bhutanese corporations could be genuine, pragmatic, and rational. However, their views on leadership are very general and not specific of any segment of leadership in their organization. The details are presented in the following paragraphs.

Bhutanese Leaders, according to the participants tend to be ‘bossy’. One participant stated “leadership, in general, leadership in business, or as per my observation, I am less aware of leadership outside, but especially when we say Bhutanese leaders, a little bit of ‘bossy act’ is certain” (P6); similarly, another interviewee agreed saying:

...mostly, to be very frank, when you get into certain position, they really, [have] feeling that they have reached the top now. Some think that all work will be done by subordinates, of course the subordinates do, some are not even able to provide leadership, and some focus more on ‘nitty gritty’ things [micromanagement].

(P5)

And the most straightforward point by one of the participants is that “the current lot of leaders in the Bhutanese Corporation are mainly born out of the non-functioning civil servants and so their mentality of I am the boss needs to be changed”.

Another quality which our leaders generally have is interesting. One may call it ‘culturally induced’ that our leaders find it difficult to say ‘NO’. One participant mentioned that “generally, in our case, of course as a leader, you can’t be having double standard, [but] generally we can’t say ‘NO’”. And this very Bhutanese character of not being able to refuse could compromise professionalism as pointed out by participant P2:

...We tend to be individual based, kidu-centered, not being very professional; professional means, integrity, I don’t mean to say that all our leaders are not, do not have integrity, what I am saying is, professional, [tak, tak, tak], do what is supposed to be done and not what you are not supposed to; in our case, generally, people come with request [kidu-zhu], and you consider, the moment they come with all personal reasons, such as health problem, wife problem, family problem. And somehow you tend to be softer. In such case, we really cannot say ‘NO’.

There are certain aspects of Bhutanese Corporate Leadership which needs improvement. The areas of improvement as expressed by interviewees are subject knowledge, character ethic, professionalism, vision, public relations, decision making, and risk taking. The points are reflected in the following excerpts:

...Overall leadership improvement is required, I think. Firstly, in their own areas, starting from the subject knowledge itself.

If it is corporate leader in our context, I think a leader should be well versed in business and require business skills. Specifically, business subjects especially corporation related such as investment, finance, and a mix of all are essential; even HR also, as a leader, you need to have that [HR knowledge]. Although HR is not usually thought of as a direct business but it becomes the everyday part of that leader. The HR, Administration and Management becomes everyday part of his [leader’s] work. So, especially business side subjects, when it comes to finance, you don’t really have to go down to how to make the balance sheet but you have to understand the

balance sheet. You should be able to interpret the balance sheet. You don't necessarily have to prepare one. The knowledge and understanding are important. So, as a business leader, you should be at least comfortable in these areas.

(P1)

...I think, Bhutanese leaders, of course they will have to be more knowledgeable, one also needs to have readership, reading, but when you say unique, so maybe I can say you should of course, I can also read a lot of articles, and the one called 'leadership through compassion', and what we have to really as a leader is to really balance that, you know GNH and then your output in the organization. That one tangible, and how you really balance that, I feel important. You can't be too rude also, we can't be too inhumane, but at the same time you also don't compromise, you know, efficiency, effectiveness and productivity of organization. This, this one should be the unique, I think.

Professionalism, professionalism is required, is what I feel to be enhanced. We tend to be individual based, kidu-centered, not being very professional.

(P2)

...Basically, in Bhutanese Context, leaders are mostly driven by our society, as a small society, so you can not differentiate between personal and professional; even the professional aspects are taken personally, and then, example, even in a meeting, whatever discussed, you take personally. You, we cannot differentiate what is official; so, in the interest of the company, we sometimes debate or have very hot discussion, and we should not take personally. We should stop taking the official discussion personally. I have observed this, mostly in top leaders. Discussion, whatever it is, we try to be defensive, so after all, it's not for personal benefit, it's for the overall company. So, to have personal grudge, get angry, argue, fight; these are

unnecessary. It is okay to argue or debate during official discussion, but it cannot be taken personally.

(P4)

...I think, there should be a little more broadminded, and someone with farsightedness, see the overall picture of the company, what policy interventions are required, where is intervention required; and if where [wherever] he is supposed to be representing, sending or delegating someone in his/her place to represent, the level itself is different; I am giving the example, if CEO needs to be present, he has to go [and represent]; so, that farsightedness, broadmindedness, these are important. And I think, leader should also be action oriented. Then, especially, many might say, leader is not good, but we fail to monitor and coach. They only know how to find fault of employees but how we can mentor them, and coach them is missing. And when the subordinates submit the data and reports, the ability to analyse and further comprehend seems to enhance [to be enhanced].

(P5)

...Because, as stated earlier, if you cannot make quick decision- there's issue with decision making, in our corporations, I think, as mentioned, we need to improv in decision making. Not all of course. Some leaders need to improve that.

(P6)

...Should be able to take risk, and if there is clear intention, and if they have not done anything wrong, one should be able to perform without hesitation. But [in audible] people have good and clear ideas but they cannot implement because they feel that there is too much risk. I don't know what it is called exactly. There is someone who cannot take risk.

(P5)



...I think, taking leadership in the corporations, a leader should be able to make a link with government and ministries, so that the company is successful. Just education and qualification [Yoenten chamchi gi jo metubey] does not work. If one cannot make links with bureaucrats, then it does not go well, whether it is task or so. The main, I observed, is be able to make a link; the PR [Public Relations] is mainly required at bureaucracy level, for a leader to become successful. Specially in our context.

(P7)

#### **4. Leadership, Psychological Capital, Personality and Performance**

Although the measure of employee performance is well established in Performance Management System [PMS], there is no tangible instrument to measure employees' psychological capital or personality. However, it was noted that corporations seem to gauge these through certain systemic procedures. Some of the participants explained that the assessment of personality components is integrated as part of individual performance parameter. The 360-degree feedback system in the performance evaluation seems to cover certain aspects of personality evaluation. And, for the measure of psychological capital, there is indication that the employee's psychological capital is assessed during recruitment and selection stage through psychometric test and selection interviews; not all corporations conduct the psychometric test though. Thus, unlike employee performance, the data on psychological capital and personality of employees from the participants could be very subjective.

##### **4.1 Perception of Employee Psychological Capital**

The interviewees are of the opinion that employees possess certain level of psychological capital. For instance, participant P1 stated that:

...I cannot say about other DHI companies, for those who could get employment and join our organisation, I feel there is a sense of achievement. Usually, they are also very competitive; all the top graduates irrespective of from where they graduated come to us; we also have competitive entry examinations. And due to this competitive entry, they get sense of

achievement. I really do not know whether this sense of achievement and pride will stay or not, for long period of time, but over the period, once they are settled here, after two or three years, I have also observed their allegiance to the organization; they like work environment here. For example, a few graduates who were employed here could also do very well and top RCSCE [CSCE, Civil Service Common Examination conducted by Royal Civil Service Commission], at the end they chose to stay with us. In the past graduates would opt Civil service, but in the recent past even the graduates who could have joined RCSC chose to stay with us and these graduates have been doing so well at the end. I have observed this.

(P1)

...From HR viewpoint, currently we do not conduct, IQ or psychometric tests, but definitely in the performance management system which is very powerful tool for managing human resources, what we also try to consider is, to give you that constant feedback for improvement; ... Suppose, if its attitude, it gets exuded, but then system had to make sure you get right feedback how to change yourself. So, this case will happen mainly in the performance management system; we try to understand your [their] psychology, we try to understand your [their] attitude and what we also do is, in our assessment process, one is we have the target, that is at individual and the group, and the other one is 360 degrees, we call it, there we gauge your [their] competencies, some aspects. All these are there and you give feedback, I don't know you believe that can change psychological capital or not but mainly we have human beings will have flaws and weaknesses, but through the system, we try to change by giving feedback; 360 in a sense, we get feedback from top leaders, peers, colleagues, subordinates. So, I don't know if this can really answer your question, but we really try to know the person through emotional intelligence as a person. This is linked with the system. All these are in built in the PMS [Performance Management System]; we look for your initiative, proactiveness, we look all these; so, everything, all things, to do with behaviour, personal behaviour, professional

competencies, all these are captured in the Performance Management System. If you [they] have come up with new ideas, how you [they] think of doing same thing, same work, in different manner, how you [they] want to proactive, how innovative you [they] become. We consider all these.

(P2)

...I think this topic is very important, especially from the HR side. So, psychological aspects are very important. Currently, those employees who are already part of us, we cannot fully capitalize, but may be during the recruitment, we conduct psychometric test; to see how are the applicants but cannot really capitalize on it.

(P4)

But the unanimous agreement of the participants is the importance of psychological capital in corporation. A link can be established between psychological capital and employee performance as per the interviewees' perspectives. The participant P3 agreed that "the employees' psychological capital will benefit the company. A resilient employee will never back away from a task and so the benefit will come to the company". Similarly, P2 also supported by saying that "we have to be mindful of all those [psychological capital], because it impacts your performance". And the much-detailed statements are contained in the following:

...I think this is very necessary in the corporate world. I would say, in any service delivery. Because, if you are not in good health or emotionally stable, then you won't be able to interact with customers; even if you interact with customers, your interaction will not be good. And you may get into arguments and reply improperly. So, customers are not happy with those kinds of conversations, and probably it will lead to the customer anger. In real corporate sense, your sales will drop and impact revenue of the company. ... So, my take on this is, people should be emotionally stable and I guess, if you have to have them, then you should have motivated employees, who can handle customers well. It will enhance company sales

and revenue.

(P5)

...When it pertains to psychological capital, I have understood as employees' confidence, and positiveness in their mind. The employees' psychological capital benefit on the organization is definite. Because, hope, self-confidence, resilience and positive thinking, if employees have all these, definitely they benefit organization.

(P6)

#### **4.2 Leadership and Psychological Capital**

Also, participants believe that leadership can enhance psychological capital of employees as pointed by interviewee P1 that "a leader can provide hope to the employees by showing all the good the company is doing or will be doing, which will enhance the psychological capital of the employee". To establish this fact further, the following interview excerpts are provided:

...The leadership can really influence [psychological capital of] these employees; because how you manage these employees are up to the supervisors and leadership; how you motivate and how you potentially develop them, and make them, even how you challenge them, and make them more competitive in the work they do and, in the job-market would really matter in that particular person. Especially to the young ones who have lots of potential matter. While salary and all can play a part, but it is not everything. How you can motivate these employees by challenging them and give them interesting and challenging assignments; keep in touch with them and review their performance; let identify development areas and make them more capable and challenge them; all these would keep on the toes. They will be engaged. That role has to be played by the leadership. So, I can say that leadership play huge role in keeping that motivation.

(P1)

...I think, leader is very important for [employees' psychological capital], because, if there is a decision, if its top decision, implementation is necessary. So, if the proposal coming from subordinates do not get enough support [from leaders], it cannot be implemented. So, I think leadership is important.

(P4)

...If the question is, can leadership enhance employees' psychological capital, I think, "yes". So, main is that employees need support, even if I take myself as an example, I have my supervisor, as per my experience, leader's support is required. If we can support our subordinates, they can hope to do better. This is what I think. One is, if they have our support, they can be confident, they can build confidence [confidence], whatever they do, they can build confidence, I feel. Then, another is, if the [there is] leader's support, the subordinates become resilient, strong, so, then, if leader could give them confidence, hope, then they become positive in whatever they want to do, and they can do better, I think. I think leadership is very important for the psychological capital.

(P6)

### **4.3 Leadership and Employee Performance**

There is a strong perception that leadership influences performance of employees. The level of zeal and motivation to work hard all depends on the leadership. The ability of a leader to inspire, be a role model, and use relevant skills and aptitude play important role. The following are the statements based on their experiences:

...It [Leadership] has consequences. It has impact on the subordinate performance. Once inducted into the organizations, how you develop a person depend entirely on you as a leader or supervisor. For example, I take the example of direct subordinate, how much he can perform, how much he can contribute and at what level he performs, his motivations to perform, it



will all depend at the end on you; you as a leader, whether you are doing enough to materialize his performance, whether you are doing enough to develop in the areas he is not performing well, whether you are showing him the right path and direction, whether you are motivating enough so that he can perform on the job. So, these are the reasons. And I think, Leadership, whether it is leader or supervisor, plays a big role in the performance of your subordinates.

(P1)

...Yes! Leaders play very pivotal role, because they are the ones people will look up to. And they have to be knowledgeable, and they have to be leading by example. They have to walk the talk, and they have to be, one more important thing, what I personally believe is they have to be fair and just. Because they may be knowledgeable, they may be, you know, having exemplary kind of leadership of quality but sometimes if they tend to be unfair, then that's where we go wrong, because, for example, in our \*company. (\*Our company' instead of specific corporation is used). I have been telling my colleagues though I am new here, I am saying that for now, I think is \*\*Dasho, who is trying to have our company going to firm, stable, but then can we have this kind of leaders forever? It depends, I think. So, my point here is, it really matters [for employee performance]. (\*\* Name of Dasho was removed to maintain participant confidentiality.)

For example, if I am not fair, people will not look up to me, they will not listen to what I am saying, and then, at the end when they don't listen to what I am saying, I will not be happy with them and all things, you know, this kind of animosity will prop up and then there will be no harmony in the organization. So, you fail to grow professionally, personally, and I fail to grow as leader myself. So, Leader, it has direct relationship, because leaders are the ones who create that ambience for people to grow, people to thrive, and people to be happy. So, they are the ones be it directly or not, because leadership qualities will have to be reflected in terms of policies, programmes, directives, rules and system. All in their hand, I think. So, I

think, leadership has direct bearing [to employee performance].

(P2)

...The performance of the employees will be fully dependent on the leaders. A leader who encourages critical thinking and voicing thoughts by the subordinates will be able to deliver much better results than the one who suppresses such ideas. The reason is there is no single person who knows and can do everything, so it is always important to encourage employees to think and act on their thoughts.

(P3)

...Yes! There is a consequence of leadership on employee performance. One is that the employees' performance depends directly on their supervisor's leadership. If a supervisor can plan in advance and guide, give them directions, performance of employees will be different. If we compare subordinates under different leaders, the leaders who are dynamic, can lead, give directions, their performance will be a little different [indicating better performance]. Some [leaders], they give one year's performance target and wait till the end, without caring in the middle, no interventions, no monitoring, no performance updates, and if there is no initiative from leader's side, employees may forget or tend to procrastinate for the last minute; so, performance will be less. That way performance depends on their leadership.

(P4)

...In fact, in general, leaders, if we classify, there are good leaders, bad leaders; of course, working under the good leaders is, to me is, what I saw in last 20 years, employees tend to be highly motivated because leaders encourage you to work, provide better environment, encourage, and then productivity among employees will be high and leader would provide resources to achieve whatever is given to them; so, other than that, good leaders also, some are good in cost control, some good leaders focus on

timely achievement and targets, if you achieve those targets, he keeps the motivation high among employees and improves productivity. That's how the circle is. But of course, there are bad leaders, if the leader is not keeping employee motivated, performance tend to be lagging. Staff are less motivated. Then low productivity, and in the last, there will be issues in achieving targets. And of course, they say this and that, but they might just say all those to please, but not really working but whereas when good leaders come into picture, who can make you to work without having to tell you to work. That is the difference I observed over the years.

(P5)

...Of course, I think, Leadership makes difference on employee performance. For employees, good leader matters. If they have good leader, they can perform on time, another is, mainly, they require leader's guidance; and one [leader] should be a good decision maker, then, one is, whatever decision management takes, a leader should pass on timely, then employees actually take action accordingly as per the plan. However, when decision is not made on time, and subordinates without the decision of leaders or supervisor or the management, employees are left without any authority. Ultimately, employee performs based on the decision of the supervisor or management. If the management or supervisor are not effective in decision making, it impacts employee performance, I think.

(P6)

...Leadership and employee performance are naturally related. This is because, even if the leadership is authoritarian, it compromises the outcome/output, when the ones in the top are very tight, then it leads to the ones in the lower [subordinates] becoming tough; Even if the tops ones are indifferent [being laissez faire without directing much], it also does not bring performance, as the subordinates becomes habitual inactive. The best is to be in the middle; there are some who are purely concerned only with the work/task, without considering from the employee's personal side; they only

require task to be performed no matter what their personal issue is. They feel it is not their problem. So, even this is not okay. Hence, to have performance, a leader should sometime be tough as situation demands, and sometimes be flexible, and be able to understand the personal life as well, not just official work. It is not necessary that a leader should solve their subordinates' problem by providing money [cash] or so, but even an emotional touch, for instance interacting and asking if everything is okay with their subordinates, can make employee happy. They feel the concern of their leaders. Once they are happy, employee works genuinely and the performance naturally enhances. This is what I feel.

(P7)

#### **4.4 Opinion on Employee Personality**

As expected, and as dubious the question was to ask about the composition of employee personality in the corporations, all interviewees believed that their corporation is composed of different kinds of personality types. And it was only logical to have different kinds. And they stated that the employee personality is determined by the kind of jobs or task they take, and no one single personality befits all jobs. Hence, there is consensus feeling among the interviewees that some jobs such as marketing would require employees with extrovert personality while some professions would require conscientiousness more than any. Thus, it could be deduced that no single personality is a perfect match for every job. The following are the excerpts on personality composition in the corporations:

...As a whole, in [my] corporation, I think, there is a mixture, mixed, of personality. In head office, the requirement of personality is different, another personality is required to deal with customers, and again as a \*specialist, you require personality, as an engineer, you require an engineer personality; in here, we have the mixed [employee] personality. (\*The specific profession is replaced by 'specialist' so that identity confidentiality of interviewee is maintained.)

(P6)

...I observed, majority are introvert here. Because, some are emotional, extroverts are one or two. I guess, nature of works also determines. But if it is at outside, they talk too much but they say very few about official related. I don't know whether that is even introvert or not. There are ones, who do not have confidence, not sure whether it is due to lack of opportunity or through schooling, all these things start from schooling, I think. I won't classify as introvert, extrovert, but when it is about official, they find tough expressing, [in audible] yet when they speak with friends, they tend to talk a lot, talk about heaven and hell. I don't know how to summarize the answer.

(P5)

...So, if \*this corporation is a person, I think, it will be proud person with full pride, I won't say egoistic, I won't say egoistic, but a person with full pride because most of them are professional, technical people and then they know that are the backbone of national economy. So, while I say it, a personality with full pride and dignity, and responsibility. Because we have responsibility, you know this corporation is the main, backbone of the economy at the moment. So, I can say, if you want to put that way in terms of personality, I can say somebody who is matured, responsible, and proud.

(\*The name of actual corporation is replaced with 'this organization' to be non-specific.)

If you look at head office, all engineers, all professionals, highly qualified, then, but that does not mean that, but looks like, in the head office, although they work cooperatively, but really do not 'mingle'; they are very professional. They do what they are supposed to do. Like in other office, we here, do not mingle and gossip [shetho-chap deney mey]. This is one. They are serious about business.

(P2)



#### 4.5 Personality and Performance

According to the interview participants, employee personality is not really a determining factor for their performance. While the personality type, for instance, extroverts may be able to communicate well and have good public relations which would be added advantage in being effective, it does not necessarily translate into being productive. In this context, participant P3 stated “this [personality] will depend on the type of work. You cannot ask an introvert to be a marketing person. Also, you cannot expect an ambitious person to work in the same company for a long duration.” They are of view that, performance is matter of how individuals are managed than their personality per se. To connect the point, the following excerpts are provided:

...Sometime it depends on the work they are doing but overall, in general, employee personality will not make much difference. For some, it is determined by the job. For example, media and public would need somebody with that kind of personality but if it is in investment or if it is in finance, anybody can do. Again, their personality, if you are good in aptitude in numbers, it also matters. It really depends on the job. Overall, as long as, at the end of the day, if you can fulfill the terms of reference, if you can do the jobs as required, in general, personality does not matter. Again, also depend on what position you are taking.

(P1)

...When it comes to personality and performance, whether employees who are open perform well, it's not true. Our performance is driven by facts and figures. If you check all the DHI companies, you check their PMS [Performance Management System]; some may claim I accomplished such and such task and deserve 90 percent, but their own rating cannot be the basis; some may say I completed in April despite the fact that deadline is June; but in our case, its system driven. ... Someone could be very talkative, and management is not always downwards, it's how you manage is important; so, some employees may be very good at how you manage your boss; so, if this is the case, may be their performance [rating] can get high.

So, personality is not a parameter; in here, we have, like, behavioral evaluation, and output evaluation. So, behavioral evaluation takes only 30 percent, and output evaluation is 70 percent, so, if you haven't worked and have no output, it cannot be that way. The reason for keeping behavioral is to see how is your PR, how you deal with; have rating on this which carries only 10 percent of behavioral domain; So, may be there could be a little difference as we need to deal with and talk to others, build team and cooperation. If one could do this, that person will get high rating, but that rating is very limited, behavioral evaluation. May be that also in his performance, in output, because of his nature, being outspoken and have good PR; so that can assist in completing the task; those who cannot express and share and does by himself, it is his own fault, so, in that way his performance could be affected negatively, I think. May be a little difference could be there [because of personality] but not so much, I feel. Actually, as long as you complete the task you are required to do, does not really matter.

(P4)

...employee personality will not have much impact on their performance. This is because, initially, individual rates their own, only after self-rating, a supervisor rates, after that supervisor's supervisor does the rating. Only after that, HRC [Human Resource Committee] review. So, as of now, I have never observed that personality has direct effect on rating [performance]. I have not seen major impact so far.

(P7)

...Not so sure, how to answer this but then different personality types need to be managed differently for the team to work properly. An introvert may be shy so communication with an introvert should be either within personal space or in writing. You cannot expect an introvert to come to a meeting and share their ideas in the forum. So, it is only a matter of management.

(P3)

## 5. Personality, Happiness, and Job satisfaction

Participants were asked to rate their employees' happiness or job satisfaction on the scale of 1 to 10. Their scores range between 5 and 9; they provided probable reasons for perceiving their employees satisfied and dissatisfied. One participant who rated the highest stated:

...I would rate 8 to 9, but there might be like I said, still areas for improvement; we have flat structure and career progression is limited in terms of normal progression. To get to the next level position after certain level, there should be vacancy and face open competition. This may be reasons for some employees feeling dissatisfied. However, we have feedback system.

And participant who rated in between highest and lowest says:

...I feel it should be between 6 and 7, but let's keep at 6. Because, if I say not happy, generally we are all happy. Because, most of our expenses are taken care of by the government, health, education; and what we get is to look after the welfare of our families only; [in audible] they may be poor but not deprived of basic facilities or requirement in life. Even if I say, they are too happy, the other things come, materialistic; despite having a basic facility for life, we have desires that can push our happiness down. I am talking about the monetary point of view, other happiness could be because, very good environment, have good government and good governance system; at the end there are socio-pressures. That's why I am keeping at just 6.

I think if we are rated low [by employees], probably one could be wage itself, the salary, other could be living conditions, many people are living in a very remote areas, poor living conditions, then poor network connectivity, and have health and sanitation issue. That might trigger them to rate low. And I am sure, the people enjoying better facilities, and who are at the moment in a better location, working with lot of facilities in and around, that could also really determine their happiness. And some people are living away from family, we have many, into the forest. So, family live by nearby

settlements, nearby forest. That could also lead to low [rating]. Those could come in to play. Sometimes, what you go through at that particular moment also trigger you to rank[rate], like you are having family problem or your parents are sick, children are not getting into good college, then those are not directly related to office work but you tend to rate low because of your family problems or other circumstance. Ratings can really swing. If somebody is not feeling really well for last here days, you don't expect him to rank he is very happy. All those things will come into play.

The following is an excerpt from a participant who rated their employees' happiness lowest:

...I think, as of now, the employee happiness [of the corporation] may be around 5 out of 10. Recently, government had 'managed out' and DHI corporations also take austerity measures, so, almost all are not so happy these days. That's why, it [happiness] may be around 5 currently. Just my opinion. And most are concentrated on leaving for Australia, which diminishes the current task at hand.

On the topic of personality influencing happiness or job satisfaction, participants expressed that while charismatic, open-mindedness or extroverts might be able to associate with others and be liked and admired by colleagues and people around which elevate their feeling of good. However, they still believe that personality cannot be determining factor for employee happiness and satisfaction. The following are the excerpts related to this perception:

...And I think, the feeling of satisfaction is not dependent on personality. There are introverts who are happy and there are extroverts too who are happy. Satisfaction based on personality is, I cannot say accurately. I think, there is not much linkage between the two: personality and satisfaction or happiness.

(P7)

However, one of the participants opined that personality does matter how one feels happy and satisfied as he puts:

...If you look from the happiness perspective, you must have observed that, generally, the extroverts are, they are liked, and they are recognized, and of course if they are recognized, their happiness increases. So, in a sense, the relation between personality and happiness is there, not sure if there is good tool [to assess], I don't know. But generally, personality with, good personality would outshine others in the system, and when you outshine, you are given the importance in the system, you are looked up to by the company, then if the motivation is high, the happiness increases. Personality does matter, and it is related to happiness.

### **Summary**

The research findings are based on 511 employee survey data and seven interviews. The male represents 65% of survey responses while there is not even a single interview participant representing female. In terms of leadership score by companies, the DHI seems to top the list with mean score of 4.302; however, there is no statistically significant variation of perception of leadership among the corporations. The leadership Index of DHI and its companies stands at 0.858. The overall mean value of GNH in Corporation settles at 4.47 with 'concern for culture' domain scoring 4.84 as highest and 'training and education' lowest with just 3.86. The 'GNH in Corporation' Index based on Alkair-Foster formula is 0.500109. The overall mean value of self-rated employee performance and psychological capital is 4.098 and 4.96 respectively. The test of relationships among the variables shows that both GNH in Corporation and Psychological Capital partially mediate the effect of leadership on employee performance.



## CHAPTER V

### DISCUSSION AND CONCLUSION

#### **Outline**

This chapter intends to examine, interpret, and describe the results and findings. The content reflects leadership status within Bhutanese corporations and its consequences, the comparison of findings and the current knowledge, interpretation of GNH in Corporations and its application, employee psychological capital, personality, and their performance. The chapter reviews and puts the findings into the context of overall research scope and purpose; of course, it also deliberates the significance and contribution of the research. Finally, the limitations of the study and suggestions for future researchers are also conveyed.

#### **Leadership and its consequences in Bhutanese Corporations**

Leadership in any organization plays a crucial role. In this research study, the status of Leadership in Bhutanese Corporations is first examined and reported as descriptive statistics. However, the important objective was to test if the leadership in these corporations has statistically significant influence on GNH in Corporation, employee's psychological capital, and performance. The analyses and results are based on Structural Equation Modelling. The findings from the full structural equation model suggest the presence of significant effect of leadership on GNH in Corporation as well as employee performance. This implies that leadership is crucially responsible for alignment and enhancement of GNH conditions and employee performance in the corporations. However, it is noted that leadership does not necessarily improve employees' psychological capital; similarly, GNH in Corporation does not cause employee performance significantly. These results are not erroneous but the causes for these weak associations can be attributed to the very strong link, particularly between GNH in Corporation and Psychological Capital, and between leadership and employee performance. This is because, when all the variables are placed in the multiple regression model, the influences on and from different directions manipulate and even subjugate the intensity of some relationships. When simple regression is

tested for Leadership and Psychological Capital, the former in fact induces the later. Similarly, GNH in Corporation determines employee performance when other variables are excluded. Thus, it can be interpreted that both the relationships, between GNH in Corporation and employee performance and between leadership and employee psychological capital are in fact positive and significant.

These findings are comparable to the interview data. The participants expressed that leadership can be instrumental for implementation of GNH in Corporation, especially in the context of deriving more profits and contributing to the government exchequer for the economic development and higher living standard; equitable social and economic development is one of the four pillars while living standard is one among the nine domains of GNH. This national economic empowerment is especially expected from the DHIL and its corporations which serve as the major economic contributors for the government exchequer. Taking this into cognizance, the DHIL and its corporate group commits to increase the national internal resources five folds and also be able to finance the entire recurrent expenditure by 2030 (Druk Holding & Investments Ltd, 2021b) as the government aims 'Developed Bhutan' status with GDP of \$10 billion by 2034 (Zangpo, January 14 2023). The 21<sup>st</sup> Century Economic Road Map (Draft) proposes to achieve high income nation with Gross National per capital income of more than \$12000 (Choden, March 6 2021). Thus, leadership can have a huge role in realizing this dimension of development. It is also important to reiterate once again that GDP and GNI are in fact complimentary to GNH.

Also, links could be established between leadership and how they manage their subordinates and their job satisfaction, besides taking initiatives for cultural and environmental conservation. However, the interview data do not reflect all the dimensions of GNH comprehensively, albeit their understanding of GNH in Corporation revolves around money/profit making for national development, ensuring safe and conducive work environment, good governance, socio-cultural participation and contribution, and environmental conservation initiatives. All these, interview participants believe, could be determined by their respective leadership. There is also strong consensus among the interviewees that employee performance can be encouraged by the ability of their supervisor or leader in being their role model in

terms of character, ethics or broadly by their behavior. Most noteworthy point was that employee performance is a result of their motivation and the level of satisfaction and psychological capital, all of which the participants believe, can be induced by leadership of their supervisor. Additionally, they opined that leadership cannot be 'bossy' but someone visionary, communicative, being able to recognize the emotions and human side of employees, and one who can balance both business task and people. All these lead to employee happiness, satisfaction, motivation, psychological capital, which in turn stimulates subordinate employees to perform better.

The GNH in Corporation and Psychological Capital both partially mediate the relationship between the leadership and employee performance. The findings are ascertained through tests of different mediation models. When both the intermediate variables are tested as multiple mediators through the parallel mediation, both of their intervening effects are significant. Moreover, their mediation effect tested as a standalone intermediary through single mediation models also generates statistically significant result. In addition, the serial mediation analysis also postulates positive and significant effect. All these findings suggest that the effect of Leadership on employee performance passes through both GNH in Corporation and Psychological Capital. Hence, the conclusion can be drawn that corporations which have good leadership embracing GNH in their organizations to reap the benefit of higher employee performance. The point is alignment of GNH in the corporations resulting enhanced psychological capital can bring added value for the corporations.

On the other hand, the employee personality as a composite variable does not moderate any of the relationships, i.e., between leadership and employee performance; leadership and GNH in Corporation; and leadership and psychological capital. However, when moderation is tested at traits level, 'Open-mindedness' and 'Neuroticism' moderate the relationship between leadership and performance. The post-hoc test through 'pick-a-point' analysis shows that both personality traits weaken the relationship. From this, it can be inferred that the higher the employees' open-mindedness and negative emotionality, the effect of leadership on performance drops down. The 'open-mindedness' personality trait is measured based on whether an employee is fascinated by art, music, or literature, has interest in abstract ideas, and whether he/she is original and comes up with new ideas. The moderation of this trait

is supported by the interview data as well; interviewees expressed that not all leaders in the corporation appreciate and accept the opinions and genuine recommendations of their subordinates which discourages employees in contributing ideas any further. Neuroticism (Negative emotionality) trait relates with a character of a person who worries a lot, tends to feel depressed, emotionally unstable and gets easily upset. This is where the importance of Psychological Capital come in; although the personality traits may be inherent and long lasting because of different situations and conditions, both through genetic and exposure with the environments, the Psychological Capital is dynamic. Thus, the leaders should understand that focus on enhancing employee psychological capital may be a solution for employee's negative emotionality.

### **The Findings and the existing Knowledge**

There are many definitions and types of Leadership identified in existing knowledge of literature. The most prominent ones include 'ethical leadership', 'transformational leadership', 'self-leadership', 'servant leadership', 'authentic leadership', 'inspirational leadership', 'planetary leadership', 'situational leadership' etc. which seems to have derived from recent leadership theories. And there are evidences through prior research and studies that these leaderships stimulate employee happiness, psychological capital and employee performance. Ethical Leadership was found to have significantly influenced employee wellbeing mediated by job satisfaction (Yang, 2014), leader-follower value congruence (Tang et al., 2015), task performance (Yang & Wei, 2017), and psychological capital which in turn influenced in-role job performance (Bouckennooghe et al., 2015). Similarly, transformational leadership determines employees' contextual performance (Pradhan, & Pradhan, 2015), civic virtue behavior (Khan et al., 2020), innovation culture, innovation strategy, new product development process and product innovation (Sattayaraksa & Boon-itt, 2014), followers' job satisfaction (Samanta & Lamprakis, 2018), and psychological capital (Gooty et al., 2009). These are just a few from the literatures suggesting leadership causing employee's performance, psychological capital and wellbeing. Going by the general trend, any leadership bears similar outcomes. The findings from the current research study are not so different from the results found in the existing knowledge of literatures. The current research ascertained

that leadership in the corporate organisation significantly influence performance both directly and through mediation of GNH in Corporation and Psychological Capital. However, it is highly likely that the findings in this research pertaining to relationship between Leadership and Psychological Capital and between GNH in Corporation and employee performance could be misunderstood as stated earlier if it is not clarified. Based on the full structural model, these relationships are not only 'non-significant' but their regression weights are in negative terms. The misinterpretation could be that the existence of GNH in Corporation does not convert into performance while Leadership has no role in enhancing employees' psychological Capital. The consequences of these misinterpretation could be costly in the long run which might come in the form of policy interventions. Why should corporations care for GNH in Corporations if it only relegates performance? And why should leaders make an effort for enhancing employee's psychological capital if their leadership does not bear any association with it? So, this is how things can change as a consequence of these results if misinterpreted.

To make it clear, the findings from the full model about these relationships is attributable to the fact that many variables are integrated into the same model of multiple regressions, exposing influences on and from different variables. The intensity of relationship can only change and even be subjugated as a way of adjustments within the model. Thus, specific relationships were tested separately. When the relationship between GNH in Corporation and Employee Performance is tested as independent and dependant variables limiting the influence from and to other variables, the relationship is not only positive but statistically significant as well. This shows that GNH in Corporation influence the level of employee performance. Similarly, Leadership is found to effect employees' psychological capital when their relationship is analysed as simple regression. In fact, Psychological Capital and GNH in Corporation also partially mediate the relationship between leadership in the corporation and employee performance. This could be understood that Leadership induces influence on these variables which in turn effect the employee performance. The noteworthy implication from these results is that corporations whose leadership align GNH values and enhance employee positive psychological resources can



outshine other organisations, particularly in terms of employee productivity. This shall have the associated advantage for overall organisational level performance.

The results of the analysis of moderation effect of employee personality reflect that personality as composite variable does make any changes in the relationship status, namely: between Leadership and Employee Performance, between Leadership and GNH in Corporation, and between Leadership and Psychological Capital. This clearly reflects that personality, in general, is a neutral phenomenon. However, when the moderation is tested at trait level, 'open-mindedness' and 'neuroticism' seem to moderate at least the relationship of leadership and employee performance. The post-hoc 'spotlight' analysis reveals that these two traits weaken the relationship. There are some studies concluding the moderation of personality between leadership and performance; for instance, Yang and Wei (2017) based on the research conducted on Chinese companies stated that proactive personality moderated ethical leadership and task performance mediated by organisational identification. There are other sources as well supporting the moderation of personality. However, the present findings do not concede to such finding though, as personality does not moderate any of identified relationships. In the literatures, most of the studies have found personality as a factor in perceiving leadership. For instance, Felfe and Schyns (2010) have found that employee personality is associated with how they perceive leadership and their commitment to their supervisor and the similar conclusion was drawn by Stelmokiene and Endriulaitiene (2015) as well; of course it's not really about moderation of personality on leadership and performance, the connection can be very well put into the context even through common sense. The personality is also found to correlate with psychological capital; Brandt et al. (2011) have concluded the relatedness of these two variables in a study conducted across cultures of the parts of Europe. The present study shows no moderation effect on any of the identified relationships. To put it simply, personality of employee is nothing to worry about or focus as it does not affect the relationships.

### **Decoding Leadership in the Corporations**

The Leadership in Bhutanese Corporations is not really a big issue going by the Index value of 0.858 which implies presence of strong leadership. The index computed based on Alkaire-Foster Method considers two levels of thresholds, first at indicator level and subsequently at domain level. Among the total responses of 511, 51.27% fail to fulfill the satisfaction of two domains (Headcount Ratio =  $262/511=0.5127$ ) which forms the intensity of 0.2770. The index is first calculated as the product of the 'Headcount Ratio' and the 'Intensity' where the score obtained is 0.1420. The score is then subtracted from 1 to obtain the final index. It is really encouraging to note that the highest portion of respondents, 32.5 % achieved satisfaction cut-off point of all the four dimensions of leadership and 16.2% were found to have satisfied at least 77% of the four dimensions. Hence, the proportion of employees who feel that the leadership in the Corporation is meaningful stand at least at 48.7%. And 24% of the proportion feel that at least two leadership dimensions need improvement. On the other hand, there are also 27.2% participants who perceived leadership should be improved in all four dimensions. Considering the mean scores of leadership dimensions, the Leaders in the corporation could focus more on enhancing Leadership Skills and Leadership Character. Leadership behavior seems to be quite agreeable to the subordinates. Taking the behavioral aspects into consideration, leadership in the organization seems to be a little more 'task oriented' with a mean score of 6.8721 compared to 'people oriented' with value of 6.7953; the difference is not huge though. Hence, based on the intersection of these two facets of leadership behavior, it could be concluded that Leadership within the Bhutanese Corporations fall moderately under 'Team Management Leadership' style. This Leadership style is ideally identified when Leaders have high concern for both employees and the profit (9,9) where the benefits of both efficiency and effectiveness are generated. Although there is space for improvement as the mean scores suggest (which are less than 9 as of now), the current Leadership seems to be able to balance both.

Does perception on Leadership differ significantly based on the organizations, sex, and or based on position levels of employees? Answering this question is important as it could identify which organization or section of employees

to be given priority. However, according to the findings, despite the differences of arithmetic mean values of leadership, no one corporation is significantly better or worse with other identified corporations, indicating that leadership is almost identical across organizations. At simple mean index level, the DHIL scores highest in Leadership with value of 4.302 while the CDCL takes the bottom rank with 3.436. These values could be sensitive to the number of participants representing their organization; after all, the sample size from each corporation was determined proportionate to the total strength of each organization. But the ANOVA test result revealed no significant differences between or among the corporations though. Thus, every corporation, DHIL and its owned companies are neck-and-neck in terms of Leadership. However, taking standard deviation into account, the perception of NRDCL on their Leadership tends to be more variable and inconsistent in comparison to other, indicating that there is a difference of opinions among the employees. In terms of the position, General Service Category (GSC) level employees rated their superiors' leadership highest with a mean value of 3.88 followed by operational level with mean value of 3.757. However, there is an indication that Managerial and Supervisory level employees are less happy with leadership of their supervisors going by the mean scores although one-way ANOVA test reveals that, perception does not differ significantly based on the employee position or sex. The Managerial level employees as the least satisfied group correspond to leadership at 'Department Head' scoring the lowest with 3.579; these heads are the supervisors for the Managerial level employees. The mean values of leadership categories of 'unit head', 'section head', 'division head', and 'other' stand at 3.672, 3.675, 3.648 and 3.668 respectively.

### **Making sense from GNH in Corporations**

The GNH in Corporation Index stands at 0.500109. The index was computed based on the Alkaire-Forster multidimensional method. Two cut-offs were identified for generating the index. First, to qualify the satisfaction at indicators level, the cut-off was decided at 4.5. The next threshold was set at domain levels, where respondents were grouped and identified as happy or not happy; if respondents have attained sufficiency in at least 6 domains of the nine, they were categorized under happy category. And, for the purpose of identifying the degrees of happiness or

unhappiness, the happiness gradient was further grouped as: extremely happy (who are happy in all domains or at least 8 domains); happy (who feel satisfied in at least 6 to 7 domains); happy somewhat (who are satisfied in at least 4 or 5 domains); somewhat unhappy (who could attain sufficiency in only 3 domains); unhappy (could satisfy only 1 or 2 domains), and extremely not happy (fails to attain sufficiency in all the 9 domains). Thus, based on these criteria, proportion of respondents who are extremely happy, happy and somewhat happy are 6.3%, 14.1% and 19.9% respectively. On the other hand, the percentage of participants who are extremely unhappy, unhappy and somewhat unhappy are 15.3%, 30.6%, and 13.9%. Although the nationwide GNH surveys are conducted periodically and the index can be compared year on year, the current index cannot be compared and extrapolate the direction of index progression as this could be the first and no such baseline index was computed earlier. The important point is to interpret what GNH in Corporation Index of 0.500109 mean. One way to understand is that the index hangs just around midway, and for full capitalization, an effort can be made to close the gap of remaining 0.49. This result was calculated on higher standard criterion. But, when the sufficiency cut-off at item level was set at 4, the index jumps to 0.988584 clearly indicating that almost all agree with the GNH indicators. The connotation of value 4 at item level simply suggest 'somewhat agree' with the statement; but 4.5 was used as indicator level benchmark to calculate the GNH in Corporation index.

The GNH in Corporation index based on the mean values of the dimensions stands at 4.47 (out of 6). Among the nine domains, employees agreed that corporations' concern for culture is much better with a mean value of 4.8 followed by community vitality and concern for environment while the training and education scores barely 3.36. In the Health domain, the overall mean value stand at 4.39, under which the values of the statements "I feel constantly under physical strain", "I feel constantly under mental strain" and "I need to undergo medical treatment to function in my daily life" are 3.11, 3.14 and 2.29 respectively. It is not so alarming in terms of their health going by these statistics as employees 'somewhat disagree' in their physical and mental strain statements. And they disagree that they must undergo medical treatment. When they were asked if they had illness or injury in the last one month, less than 20% responded they were either injured or ill. However, Ghalley

(November 30 2022) reported that among 2088 civil and corporate employees in the capital who have undergone the health screening [as of 29 November 2022] conducted by the Ministry of Health, nearly half of the screened had weight issues. In specific terms, 23% had hypertension while 31% were found to be with pre-hypertension. Also, it was revealed that 48% were overweight and 20% obese. Although these statistics are subject to change as screening was yet to be completed, at least some insights can be drawn. This tentative health screening report indicates that health may be becoming issues for corporate and civil service employees. It is also interesting to note that employees are expressing that they were busy to visit hospitals for checkups or physical activities such as games. In fact, only 48 of 511 who were surveyed in this research responded that they have visited OPD in the last one month. This could be due to their busy work schedule and the case of being indifferent to mild symptoms.

When the GNH in Corporation is compared among the corporations, no statistically significant difference was observed. The feeling of employees that there is high corporate concern for the culture is in line with the perception of interview participants as well. The interviewees expressed that as their corporations depend on rivers, mountains, forests, and other natural elements for their operation, they are not only spiritually sensitive but even superstitious. For instance, one interviewee participant said, “we believe in deities, we are superstitious, and then all our dams and hydropower, you know, process, whole chain is in the rivers, gorges, underground, and hence, so we really have to invoke all these.” The spirituality and belief systems are of course shaped by cultural practices. These are easily verifiable; annual office rimdo (spiritual puja) that every corporate organization initiates is one example. In its official website, Druk Green Power Corporation Limited (n.d) states that the corporation “conducts Baza Guru Dungdrup and drupchhen at Chhukha Zangdopelri, and Mani Dungdrup at Rinchentse lhakhang annually”. To relate it more, the Druk Holding & Investments Ltd (2021a) in its annual report reflects that a total of 4.92 million has been contributed to the activities initiated by NGOs, CSOs and institutions as part of Corporate Social Responsibility. And it is noteworthy that under this contribution, financial support was made to at least eight religious institutions and



foundations in addition to three separate cultural related projects. These references authenticate the importance placed by DHI and its corporations on cultural aspects.

However, some interviewees pointed out the need to bring national language (Dzongkha) to the forefront of corporate official correspondences. The survey data reveals that almost everyone in the corporations is comfortable with the national language. The mean value of the survey item “I can use Dzongkha well for communication purposes” is very high at 5.24. And some interview participants expressed very strongly that the requirement to use Dzongkha in official communications and correspondence should be reflected in this report. Although the implementation might require planning, effort and even collaboration with relevant agencies and stakeholders, the corporations may at least consider if this is genuine and do able; some steps can be taken. One way forward could be by linking and converting the usage of national language in official correspondence, for example issuing office orders, with the corporate performance. Again, this is the suggestion from the participants.

The least agreed by employees among the nine domains was ‘training and education’ with a mean score of mere 3.86. When the pattern of mean values by position level was examined, the executive and managerial level employees rated high with 4.38 and 3.92 respectively. This may be a signal that they could avail themselves of training and development opportunities comparatively better than the other groups although it is not statistically significant. This domain of training and education was measured based on whether employees could avail short and long-term training as part of job-related upskilling interventions. The ratings of Operational and Supervisory levels are the lowest with 3.79 and 3.82 respectively. For the general statement “I am happy with the training & development opportunities”, the mean score stands at 3.74. But, when short-term and long-term training opportunities are compared, the former takes the lead with a value of 3.96 while the later score stand at 3.55. This suggests that employees get more short-term training and upskilling than long term study opportunities. In the context of the importance of human resources, the DHIL and its group also identifies ‘Human Capital Excellence’ as one of the guiding themes for the next decade (Druk Holding, & Investments Ltd, 2021b). This recognition is timely and appropriately placed, especially when the balance of

national workforce is a growing concern. Many Bhutanese working in Government, Corporate and Private sectors are leaving for better opportunities abroad.

As in the GNH survey conducted in 2015, this survey study also contained the same psychological question: “*Taking all things together, how happy would you say you are on the scale of 0 to 10?*”. The mean value for happiness feeling for national population in 2015 was 6.86 (SD = 1.68), while the result from the current research shows the mean score of 7.1 (SD=2.01). This shows that employees under DHIL and its owned corporations as of 2021 were comparatively happier than the general population in 2015. One difference is also noted, in the 2015 GNH survey, the psychological feeling of happiness was significantly higher for male than female; however, the present findings suggest that both male and female employees feel almost equally happy without significant difference.

It is also very important to understand the corporate values as part of GNH in Corporation as these values were finalized considering the overarching philosophy of Gross National Happiness. After having referred the values of each corporation, seven corporate values were identified for this research study. They are Integrity; Equity; Responsibility; Transparency; Accountability; Teamwork; and Health & Safety. There is a clear indication that integrity, responsibility, and teamwork are much better in comparison to equity, transparency, and accountability within DHI and its owned corporations. When these corporate values are tested for significant differences among the corporations, only ‘Health & safety’ was found to differ between the groups; the health and safety practices of DGPCCL is significantly higher than in NRDCL. The practices of the rest of the corporations do not differ. As the corporation [NRDCL] is required to deploy its employees in different locations for natural resources extraction, health and safety could be a genuine issue. This concern was also expressed during the interview by the relevant official. The NRDCL may introspect, investigate, and verify its own if this result holds any truth. And it may be appropriate to mention here that the annual audit reports of the year 2021 of all the identified DHI owned corporations and DHI were referred. It is really encouraging to know that no major issues have been observed by the external auditors. In fact, all reports suggest that the corporations comply with the Companies Act of Bhutan 2016. It could be concluded that the corporations are healthy, in compliance with the

Companies Act, and other appropriate laws, rules and regulations, systems, procedures and practices. It can be concluded that corporations are serious about their corporate values which are fundamental for corporate governance.

The most important takeaway from the findings of GNH in Corporation is that it plays key role in catalyzing the role of leadership on employee performance. It also influences the level of employees' psychological capital. These are results based on the relationship analysis. On one-on-one regression analysis, the GNH in Corporation clearly impacts the employee performance, but when assigned as one of the three multiple independent variables together with leadership and psychological capital, its significant influence on output variable diminishes. However, corporations should still take GNH in Corporation into account. Although taking GNH practices into corporations may not necessarily be a factor of profit making, it somehow connects with employee performance. Now, what is important is its ability to mediate the effect of leadership on employee performance, and its strong relationship with employee psychological capital, and the effect of the later on to employee performance. Thus, the more the GNH in corporation, the more beneficial to the companies.

### **Discussion of Employee Performance in Corporations**

Employee performance data was gathered as Likert items grouped as 'Task Performance', 'Contextual Performance', and 'Counterproductive work behaviour'. In the Structural models, only task and contextual performances as performance construct were analyzed after the confirmatory factor analysis; the 'counterproductive work behaviour' had to be removed due to very low factor loading. Also, the data of actual scores in their last annual performance rating was collected. The mean values of those performance items stand at 4.098 with DHI taking the lead with a score of 4.448. Besides mean value, the task performance of the DHI ( $M=4.8$ ,  $SD=0.2667$ ) is statistically significant from that of DGPCL ( $M=4.2$ ,  $SD=0.5526$ ) which can be interpreted that their performance in terms of task planning and achieving the result efficiently on time, was truly distinctive from that of DGPCL. The inference is that in terms of the employee performance, which is directly related to the task achievement, DHI is exemplary. Even though response representation is low compared to other

corporations, it is evident that their task performance surpasses that of other. This interpretation was confirmed through ANOVA and post-hoc analysis. The rest of the performance areas (contextual and counterproductive work behavior) do not differ among or between the corporations.

In terms of the annual performance scores, the whopping majority falls within the 'Commendable' category. To be specific more than 55% of employees scored 80-89.9% in the last performance rating (which should be the 2021 performance year). What is more inspiring is that performance of more than 33% was excellent (with performance score of  $\geq 90\%$ ). These figures are but reflections of performing corporations which can also be understood together with their annual bonus system prevailing in the DHI and its owned corporations. All employees achieving 'commendable' or 'excellent' are entitled for the bonus. For instance, since after their inception in 2007, corporations have been fulfilling their targets which resulted in employees getting a bonus equivalent to a two-month basic salary. That seems to be the usual trend. Even in times of adversity such as Covid disruptions, the corporations in general have performed so well even to the extent of being able to fulfill bonus entitlement. For the year 2020, as a "gesture of solidarity for those affected by the pandemic [Covid-19] and as a part of the government's saving, the company decided to cancel the bonus" (Choden, February 17, 2021). In Fact, this simple gesture saved Nu. 344.57 million in the government's treasury for the common welfare. Thus, the majority of employees having commendable performance is not surprising. According to the data collected from employees, just a mere less than 3 percent perform below satisfactory level. The annual performance data reveals encouraging performance of employees.

When the self-rated employee performance was compared in terms of position level of employees, at least the task performance of Operational and General Service Category employees was statistically higher than that of managerial level staff. This finding is interesting because the GNH in Corporation was found to influence employee performance significantly and positively. The point is, those in managerial positions rated lowest in GNH in Corporation, and their performance can be expected to be proportionately lesser. Also, one of the interviewees stated that the satisfaction of managerial level employees could be less. Again, the reason stated was

interestingly noteworthy. There are indications that managerial employees are zealous, risk taking, opportunity seeking, early or mid-career level with so much hope and desires. However, they become unsatisfied and demotivated when their demands are not met. All these point that their performance status is true. In terms of performance by sex, there is no difference of performance scores, be it task performance, contextual performance, or counterproductive work behavior between male and female employees.

### **Take from Psychological Capital and Personality**

Psychological Capital is noted to partially mediate the relationship between Leadership and employee performance. This only shows that leadership induced employee psychological capital can translate into employee performance. Thus, leadership should consider enhancing employee psychological capital. There is enough evidence that leadership can significantly influence employee psychological capital. Psychological capital is found to be very important in the corporate setting for the performance.

Another important connection that can be drawn is the relationship between GNH in Corporation and Psychological Capital. The influence of former variable on latter is very strong to the extent that, when placed in the full structural model, they can reverse the significance and direction of other influences. For instance, in the full structural model, the effect of GNH in Corporation on the employee performance, and the Leadership on Psychological capital is not only insignificant but inversely related. But, when the influence was tested without putting GNH in Corporation and Psychological Capital in the equation, it can be observed that GNH in Corporation has positive and significant influence on Performance. Similarly, leadership statistically determines employee psychological capital. Also, the serial mediation test shows that GNH in Corporation and Psychological Capital play partial mediation role on the Leadership and Performance. This suggests that Psychological Capital can also be induced by GNH in Corporation. There is also a clue from the interview data that happiness and psychological capital are related. The participants believe that when employees are happy and satisfied, they will have hope, optimism, efficacy and resiliency. And most importantly, these are linked to employee performance. Hence, a



connection can be drawn that happiness induces higher psychological capital which can ultimately mean employee performance. Thus, it can be concluded that the employee psychological capital has a higher stake in the corporations as well.

When it comes to employee personality, it does not really make a difference in terms of their performance. The moderation tests revealed that personality does not moderate any relationships, between leadership and performance, leadership and GNH in Corporation, and leadership and Psychological Capital. These statistical results are also supported by the interview data. The interview participants expressed that personality does not determine performance. The reasons stated include, the job and personality are filtered already during recruitment and selection process, meaning that right jobs are awarded to right person or personality. Another strong reason given was that performance is system driven which is based on each employee's 'term of reference'. There is of course the perception that personality types such as openness, charismatic and extrovert may be good at public relations which can prove useful in executing certain tasks. Also, open minded and extroverts are liked by people around them which make them happy. In general, personality is not a factor for employee performance or is linked with happiness. However, when moderation is tested at traits level, 'Open-mindedness' and 'Neuroticism' were found to moderate the relationship between Leadership and Performance. The post-hoc test through 'pick-a-point' analysis shows that both personality traits weaken the relationship. From this, it can be inferred that higher the employees' open-mindedness and more the negative emotionality, lessor the influence of leadership on performance. The 'open-mindedness' personality trait was measured based on whether an employee is fascinated by art, music, or literature, has interest in abstract ideas, and whether he/she is original and comes up with new ideas.

The moderation of this trait is supported by the interview data; interviewees expressed that not all leaders in the corporation are reasonable enough to accept the opinions and genuine recommendations of their subordinates which leave employees discouraged in contributing ideas further. Neuroticism (Negative emotionality) trait refers to a person who worries a lot, tends to feel depressed, and emotionally unstable and gets easily upset. These personality traits and their moderation should be taken seriously. This is where the importance of GNH in Corporation and Psychological

Capital come in; although the personality traits may be inherent and long lasting because of different situations and conditions, both through genetic and exposure with the environments, the Psychological Capital can be enhanced. And there is evidence that GNH in Corporation enriches psychological capital. Thus, the leaders should understand that focus on employee psychological capital may be an alternative to tackle negative emotionality.

### **Contribution and recommendations of the Study**

This research may not be extraordinarily unique, but the process and findings of this study contribute to the existing knowledge in terms of practical implications and theoretical development. Although this research project was not solicited to be applied research in solving issues, the inferences could be meaningful for the administrators and managers of the Bhutanese corporations. The significance and contributions are discussed in the following.

#### **1. Practical Contribution**

It is expected that every organization or institution including business and corporate sectors in Bhutan implement the national development paradigm of Gross National Happiness. Interestingly, whether corporate and business entities operationalize this policy was doubtful which required investigation. The Centre for Bhutan Studies & GNH (2018), for instance, believe that GNH is operationalized only at governmental level but not at business level. Sebastian (2015) also pointed that the government and civil service leaders were doubtful whether GNH is valued and by business and corporate leaders in their business conduct. This study is hence the result of this knowledge gap. The result suggests that Bhutanese corporations embrace GNH in their business processes and procedures but can still be enhanced considering the score value of GNH in Corporation index. It is also discovered that GNH in Corporation is an important determining factor for employee performance. Thus, it is especially significant for demystifying those corporate leaders who doubt whether GNH at all adds positive impact to the corporations. While some past studies indicated that corporate leadership are yet to appreciate GNH in their corporations the result that reveals GNH in corporation mediating the effect of leadership on employee

performance provides reason for introspection that could change the course of belief that GNH in corporation is in fact complimentary.

The administrators and the decision makers in the corporations can mark and identify the areas of improvement for enhancement of GNH in corporations from the findings from this research. The results from the analysis of leadership data offers insightful information about the status of leadership in Bhutanese corporations. Although perception of leadership is not significantly different by corporation, sex, or position level of respondents, it may be still imperative to recognize why mean values for some companies are lesser than the overall average, and in particular, the reasons for managerial and supervisory employees in particular rating the leadership of their immediate supervisors comparatively poor. The leadership at ‘Department Head’ level scoring less provides at least two connotations: firstly, it may mean that leadership of executives on contract could be inferior; the heads of departments are always on term-based employment while unit, section, and divisions are usually led and subordinated by fulltime employees. The second possibility is that the result could be due to the rating biasness of managerial and supervisory staff influenced by the mismatch of their desires and the existing reality. They are mid-career employees with full of aspirations, dreams, and desires; the non-fulfilment of these could have resulted in unfavourable rating. The interesting notable point is that the task performances of ‘Operational’ and ‘General Service’ category are significantly better than ‘managerial level’ group. This creates the direction, probably to undertake qualitative study through Focus Group Discussions (FGDs) and in-depth interviews so that the underlying reasons can be uncovered.

The results and findings from this research could be relatable with the current human resource issues facing the country. For instance, the attrition rate of civil servants for the annual year 2022 [July 2021-June 2022] is 4.6 where alarming 70% resigned voluntarily of the 1462 employees separated (Royal Civil Service Commission, 2022); Wangchuk (January 24 2023) reported that “lack of career mobility, inadequate salary, better opportunities [outside] and red tape” are the reasons for civil servant exodus. The more alarming figure is that 812 employees severed from DHIL and its group of companies amounting attrition rate of 9.85 in 2022 [January-December] alone (The Bhutanese, January 2023). This issue of

employees leaving for better opportunities was clearly spelt out during the interviews. The Civil service and the corporations were once the prioritized organizations for employment but seems not anymore. Although, the primary reason for the attrition could be due to the better economic prospects abroad, as majority tends to leave for developed country such as Australia, there could be more than simply economic factors.

The findings from this study provide certain insights for the corporations to focus and calibrate on so that the pool of human capital is retained. The employee rating of organizational values can be one important reference for corporate administrators. Among the seven values the respondents rated 'Integrity', 'Responsibility', and 'Teamwork' comparatively better than 'Equity', 'Transparency' and 'Accountability'. And NRDCCL may identify 'Health and Safety' issues for further improvement. It is also noteworthy that the 'Managerial' level employees are the least happy group; the fact that they rated least for psychological wellbeing, time use, and good governance could be food for thought for the corporate leadership and corporations as most of the resigning and leaving the organization happens to be mid-career employees. The analysis of leadership dimensions, Psychological Capital and GNH domains including living standard, health and wellbeing, both physical and mental, good governance or so should be well considered although these factors need synchronization at both organizational and macro level.

## **2. Theoretical Contributions**

The major theoretical contribution from this study is the investigation of multiple variables through the new conceptual framework. To the best of researcher's knowledge, little or no prior study has been done investigating the GNH in corporation as predictor variable and employee performance as outcome variable. For the present study, in totality, the GNH in Corporation and Psychological Capital were poised as mediating mechanism for the relationship between Leadership and employee performance. The Structural Equation Modelling (SEM) was the primary statistical tool used to test the relationships among identified construct variables. Taking the 'Model Development Approach', generalisable SEM-based research model was developed and finalised for the analysis. This model may be replicated to study other populations. The conceptual model composed of these variables extends

the existing research in theorizing. The model can be particularly insightful for not only the DHIL and its owned corporations but beyond as it can now be theoretically settled that if the corporations are to reap the benefits of employee performance, leadership, enhanced GNH in corporation and employee psychological are ascertained to be significant factors.

GNH in Corporations significantly influence employee performance as lone predictor although its significance seems to disappear when it is put together with leadership and psychological capital as multiple predictors for the same criterion variable. The DHI and its companies, however, should not abandon their attention for GNH in corporation as secondary cause for employee performance. This is because, the mediation analysis concludes that GNH in Corporation, whether as single mediator or as a parallel mediator together with psychological capital significantly intervene the leadership and employee performance. It is found that leadership in the corporations is responsible for the GNH in Corporation in which the latter influence the employee's psychological capital which in turns significantly determine employee performance. These affirmations of inter-construct relationships are not only new discoveries or new knowledge for the current theoretical literature but also provides directions for business management and administration. The findings from the research can form basis for their organisational decisions.

Also, the Alkaire-Foster method of Leadership Index could be the first of its kind. Also, the conception of Leadership is unique. Although, the operational definition of the variable is based on the existing theories, unlike other studies which focuses on specific angle of leadership, the leadership for this study is a 'synthesised' concept based on at least four prerequisites of a leader: Behaviour, Skills, Awareness and Character. Hence, the Leadership variable was developed as a holistic construct consisting of carefully arranged ideas from multiple leadership theories. The description of leadership index using Alkiare-Foster method should be first of its kind. And one strength of leadership data for this present research can be attributed to subordinate ratings rather than self-rating by leaders themselves. Although the GNH in Corporation used the already developed framework of GNH defined through its nine domains, the items for each domain were contextualised, developed, and carefully fitted to retain the essence in the context of corporate setting. Most



importantly these items were validated by group of experts and through statistical methods. Most importantly, this study closes the research gap identified through review of literatures.

### **Limitation of the study and directions for future research**

Before discussing the limitations per se, it is important to understand the Context. This research project was part of the scholarship granted for the duration of three years. As an in-service employee, the researcher's professional and academic development was guided by the employer's Human Resource Rules and Regulations \*RUBHRRR-2017. (\*RUBHRRR-2017=Royal University of Bhutan Human Resource Rules and Regulations which became effective from July 2017). According to clause 14.5, under Chapter 6 (Professional Development) of the RUBHRRR-2017, "a staff must complete the Professional Development programme within the approved duration". And for the purpose of annual performance assessment, the RUBHRRR-2017 also reflects that "for staff undergoing PhD shall be rated as 'Outstanding' if received awards and/or completed the PhD on time; 'Very good' if completed the PhD with an extension of not more than six months; 'Good' if completed the PhD with extension of more than six months but not more than 12 months." These are the important basis for shaping and narrowing the scope of research project proposal. These conditions are not limitations by themselves but important factors pertaining to time, resources, and administrative system in deciding the project which is relevant, realistic, achievable and time bound.

The research findings were based on the data from a survey administered to the employees of DHI and its owned corporations. Although, interviews were conducted, the interview data were used only as the support information to the survey results. The research could have been much better if the survey data was triangulated through the examination of official files and Focus Group Discussions (FDGs). This research study could not review official files; in absence of legal backing such as Right to Information Act, accessing official information could be really a daunting task even if it is a public organization. Hence, it was not included as part of my data sources; of course, the annual reports from the respective corporations have been refereed and some information included in the discussion section. The findings would

have been even more valid and strong if data from Focus Group Discussions (FDGs) had been included. This could have garnered additional information where survey questionnaire could not. The present study also accounted for only seven corporations, DHI and its six owned corporations which were established in 2010 or earlier. There are different types of DHI corporations based on the DHI's shareholding. If all corporations could have been included, it would have been more generalizable.

In the case of any researcher who wishes to conduct similar study in future, the limitations of this research can be the basis of the direction. For more generalizability across Bhutanese Corporations, all the companies under DHI can be included. If possible, inclusion of other private corporations can be much better where the comparative analysis can be done among the types of corporations, DHI owned, DHI Controlled, DHI linked and private companies. This will give bigger picture of the Bhutanese companies. Also, if time and resources are in one's favour, the research methodology can be incorporated as mixed method research. The data from the survey, Focus Group Discussions (FDGs), official data, and interviews will have the advantage of triangulated results which yield more validity and reliability. The mixed method will be better because the information from the FDGs, interviews and official data will serve as extended evidence to the data collected from closed ended survey questionnaire.

## **Conclusion**

The chapter discussed the analysis and findings of study entitled "Intervening Effect of GNH in Corporation on the Relationship Between Leadership and Employee Performance in Bhutanese Corporations". The deliberation accounted revisitation of the research objectives and questions vis-à-vis the results generated through the analysis of data. The primary intention of the study was to test and validate if the GNH in Corporation and employees' Psychological Capital intervene the effect of Leadership on Employee Performance. In the process, the relationships between: (i) leadership and GNH in Corporation, (ii) leadership and psychological capital, (iii) leadership and employee performance, (iv) GNH in Corporation and Psychological capital, and (v) GNH in Corporation and employee performance were explored. The

fact that the effect of leadership on employee performance passing through both GNH in Corporation and Psychological Capital provides an insight into how these intermediary variables are important in the business corporations. This has an implication on corporate leadership, especially in demystifying the hesitation about the alignment of GNH in the corporate organizations. The higher the level of GNH in Corporation, the higher employee's psychological capital is observed which can positively effect employee performance. All these connections start with leadership which positively and significantly determines GNH in Corporation, employee psychological capital and employee performance. However, the employee personality does not moderate any of the relationship pairs. The analysis of these variable constructs provides practical implications for the managers and administrators. Additionally, the theoretical contributions are also discussed. Since the conceptual model and framework is a result of lack of prior study and the research gap, it contributes for the new knowledge.

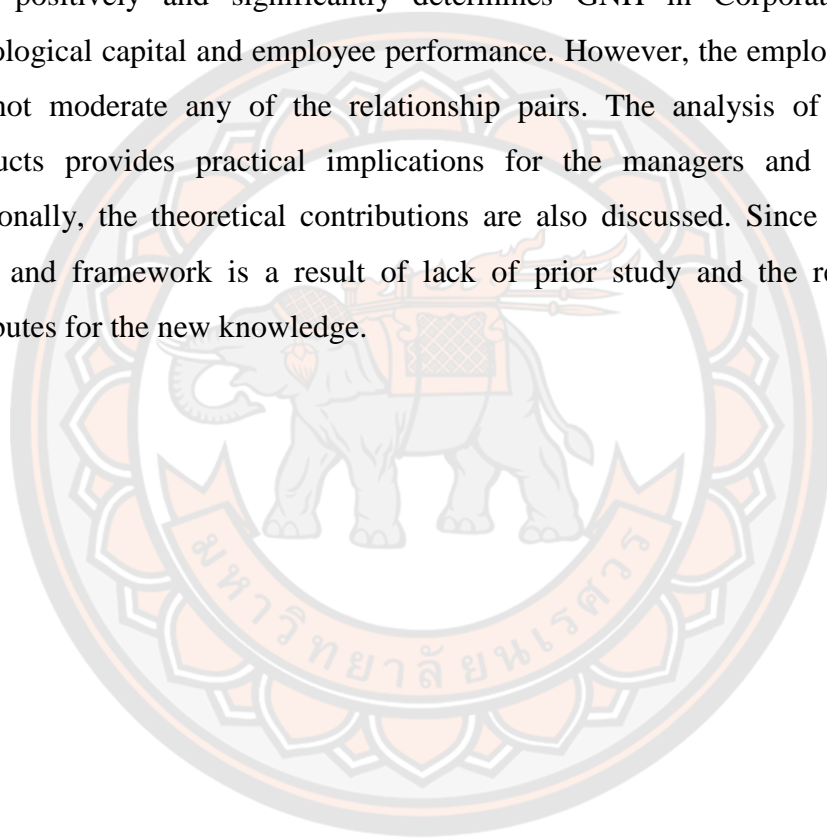

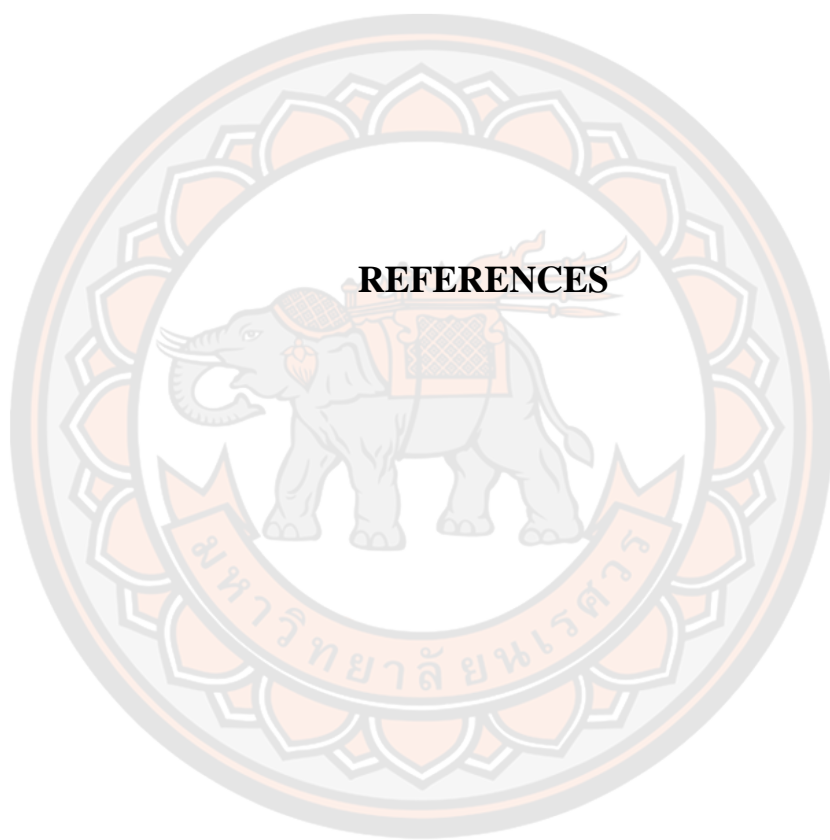

**REFERENCES**

## REFERENCE

- Adair, J. (2011). *The John Adair lexicon of leadership: The definitive guide to leadership skills and knowledge*. Kogan Page Publishers.
- Ahmad, K. Z., Alwee, S. H. S., Yusoff, Z. Z. M., Osman, S. I. W., & Tuah, S. N. A. (2003). The Association between Ethical Decision-Making, Job Satisfaction, Organisational Commitment and Selected Demographic Variables. *Malaysian Management Journal*, 7(2), 1-11.
- Alkire, S., & Foster, J. (2011a). Counting and multidimensional poverty measurement. *Journal of public economics*, 95(7-8), 476-487.
- Alkire, S., & Foster, J. (2011b). Understandings and misunderstandings of multidimensional poverty measurement. *The Journal of Economic Inequality*, 9(2), 289-314.
- Anand, S., & Sen, A. (2000). The income component of the human development index. *Journal of human development*, 1(1), 83-106.
- Antonakis, J., Day, D. V., & Schyns, B. (2012). Leadership and individual differences: At the cusp of a renaissance. In: Elsevier.
- Avey, J. B., Luthans, F., Smith, R. M., & Palmer, N. F. (2010). Impact of positive psychological capital on employee well-being over time. *Journal of occupational health psychology*, 15(1), 17.
- Avolio, B. J., & Bass, B. M. (1995). Individual consideration viewed at multiple levels of analysis: A multi-level framework for examining the diffusion of transformational leadership. *The Leadership Quarterly*, 6(2), 199-218.
- Babbie, E., & Roberts, L. W. (2018). Fundamentals of social research (4th Canadian ed.). Toronto, ON: Nelson Education.
- Bandalos, D. L. (2002). The effects of item parceling on goodness-of-fit and parameter estimate bias in structural equation modeling. *Structural equation modeling*, 9(1), 78-102.
- Barenbaum, N. B., & Winter, D. G. (2008). History of Modern Personality Theory and Research. In O. P. John, R. W. Robins, & L. A. Pervin (Eds.), *Handbook of Personality* (3rd ed.). The Guilford Press.



- The Basic Statute of the State, International Labour Organization (1996).  
<https://mjla.gov.om/eng/basicstatute.aspx>
- Bass, B. M., & Avolio, B. J. (1994). Transformational leadership and organizational culture. *The International Journal of Public Administration*, 17(3-4), 541-554.
- Bass, B. M., & Bass, R. (2009). *The Bass handbook of leadership: Theory, research, and managerial applications*. Simon and Schuster.
- Bass, B. M., & Stogdill, R. M. (1990). *Bass & Stogdill's handbook of leadership: Theory, research, and managerial applications*. Simon and Schuster.
- Bass, B. M., Waldman, D. A., Avolio, B. J., & Bebb, M. (1987). Transformational leadership and the falling dominoes effect. *Group & Organization Studies*, 12(1), 73-87.
- Belloni, M., Meschi, E., & Pasini, G. (2016). The effect on mental health of retiring during the economic crisis. *Health economics*, 25, 126-140.  
[https://iris.unito.it/bitstream/2318/1703186/6/MentalHealth\\_Retirement\\_subHE\\_R%26R.pdf](https://iris.unito.it/bitstream/2318/1703186/6/MentalHealth_Retirement_subHE_R%26R.pdf)
- Bentler, P. M., & Chou, C.-P. (1987). Practical issues in structural modeling. *Sociological methods & research*, 16(1), 78-117.
- Bertolucci, S. (2018). *Beyond GDP: Economics and Happiness*. Berkeley Economic Review. Retrieved 20 July 2021 from <https://econreview.berkeley.edu/beyond-gdp-economics-and-happiness/>
- Bhutan Broadcasting Service. (2010, October 7). *His Majesty addresses the Calcutta University Convocation*. Bhutan Broadcasting Service.
- Bil'ak, P. (n.d). *Little Ambassadors of the Country*.  
<https://worksthatwork.com/8/history-of-bhutan-postage-stamps>
- Blake, R., & Mouton, J. (1964). *The managerial grid: The key to leadership excellence* (Vol. 350). Gulf Publishing Co.
- Blake, R. R., Mouton, J. S., & Bidwell, A. C. (1962). Managerial grid. *Advanced Management-Office Executive*.
- Blanchard, K. H., Zigarmi, D., & Nelson, R. B. (1993). Situational Leadership® after 25 years: A retrospective. *Journal of Leadership Studies*, 1(1), 21-36.
- Boltvinik, J. (1999). *Poverty measurement methods: An overview*. UNDP Social Development & Poverty Elimination Division. k.

- Bouckenooghe, D., Zafar, A., & Raja, U. (2015). How ethical leadership shapes employees' job performance: The mediating roles of goal congruence and psychological capital. *Journal of Business Ethics*, 129(2), 251-264.
- Bozgeyikli, H. (2017). Big Five Personality Traits as the Predictor of Teachers' Organizational Psychological Capital. *Journal of Education and Practice*, 8(18), 125-135.
- Brandt, T., Gomes, J. F., & Boyanova, D. (2011). Personality and psychological capital as indicators of future job success? *Liiketaloudellinen Aikakauskirja*(3).
- Brown, M. E., & Treviño, L. K. (2006). Ethical leadership: A review and future directions. *The Leadership Quarterly*, 17(6), 595-616.
- Brown, M. E., Treviño, L. K., & Harrison, D. A. (2005). Ethical leadership: A social learning perspective for construct development and testing. *Organizational behavior and human decision processes*, 97(2), 117-134.
- Byrne, B. M. (2016). *Structural Equation Modeling with Amos* (3rd ed.). Routledge.
- Carless, S. A., Wearing, A. J., & Mann, L. (2000). A short measure of transformational leadership. *Journal of Business and Psychology*, 14(3), 389-405.
- Cavus, M. F., & Gokcen, A. (2015). Psychological capital: Definition, components and effects. *Journal of Education, Society and Behavioural Science*, 244-255.
- Centers for Disease Control and Prevention. (n.d). *Sleep and Sleep Disorders*. Centers for Disease Control and Prevention, [https://www.cdc.gov/sleep/about\\_sleep/how\\_much\\_sleep.html](https://www.cdc.gov/sleep/about_sleep/how_much_sleep.html)
- Centre for Bhutan Studies & GNH. (2018). GNH of Business: Proceedings of the Seventh International Conference on Gross National Happiness. Seventh International Conference on Gross National Happiness, Thimphu.
- Chaiprasit, K., & Santidhiraku, O. (2011). Happiness at work of employees in small and medium-sized enterprises, Thailand. *Procedia-Social and Behavioral Sciences*, 25, 189-200.
- Choden, K. (February 17, 2021). DHI decides not to take bonus for 2020. *Bhutan Broadcasting Service Corporation Ltd*. <http://www.bbs.bt/news/?p=143972>

- Choden, K. (March 6 2021). *Bhutan aims to achieve GNI per capita of USD 12,000 by 2030- Draft 21st-century Economic Roadmap*. Bhutan Broadcasting Service Ltd. Retrieved January 24 from <http://www.bbs.bt/news/?p=144908>
- Choiden, S. (2016). *The economics of happiness: Insights into gross national happiness in Bhutan* [QUT Thesis (PhD), Queensland University of Technology]. Brisbane, QUT.
- Ciftci, D. O., & Erkanli, H. (2020). Mediating Role of the Positive Psychological Capital on the Relation between the Authentic Leadership Style and Employees' Work Engagement: An Applied Study on Hospitality Industry 1. *Business and Economics Research Journal*, 11(2), 461-478.
- Climate Council. (02 April 2017). *Bhutan is the World's only Carbon Negative Country, so how did they do it?* Climate Council. <https://www.climatecouncil.org.au/bhutan-is-the-world-s-only-carbon-negative-country-so-how-did-they-do-it/>
- Collier, J. E. (2020). *Applied structural equation modeling using AMOS: Basic to advanced techniques*. Routledge.
- Commission of European Communities, I. M. F., Organisationa for Economic Cooperation and Development, United Nations, World Bank. (1993). *System of National Accounts*. Retrieved from <https://unstats.un.org/unsd/nationalaccount/docs/1993sna.pdf>
- The Constitution of the Kingdom of Bhutan*. (2008). Thimphu: National Assesmbly of Bhutan
- Dahiya, R., & Raghuvanshi, J. (2021). Happiness at work: a multi-criteria decision-making approach. *Journal of Indian Business Research*.
- Day, D., & Antonakis, J. (2012). Chapter 1. Leadership: Past, present, and future. In *The nature of leadership* (2nd ed ed., pp. 3-28). SAGE Publications, Inc.
- Djaelani, A., Sanusi, A., & Trianmanto, B. (2020). Spiritual leadership, job Satisfaction, and its effect on organizational commitment and organizational citizenship behavior. *Management Science Letters*, 10(16), 3907-3914.
- Drucker, P. F. (1993). *Concept of the Corporation*. Transaction Publishers.

- Druk Green Power Corporation Limited. (n.d). *Corporate Social Responsibility*. Druk Green Power Corporation Limited. Retrieved 7 November from <https://www.drukgreen.bt/csr/>
- Druk Holding & Investments Ltd. (2020). *Annual Report 2019*. Druk Holding & Investments Ltd.
- Druk Holding & Investments Ltd. (2021a). *DHI Annual Report 2021*. D. H. I. Ltd. <https://drive.google.com/file/d/1H1qLekx46LzfyMwkelVvOMCk3se0Xp0E/view>
- Druk Holding & Investments Ltd. (2021b). *Into the Next Decade: A Road Map for DHI and Group 2.0*. In. Thimphu: Corporate Performance Department, DHI.
- Eisenberg, M. A. (1989). The structure of corporation law. *Columbia Law Review*, 89(7), 1461-1525.
- Endsley, M. R. (1988). Situation awareness global assessment technique (SAGAT). Proceedings of the IEEE 1988 national aerospace and electronics conference,
- Felfe, J., & Schyns, B. (2010). Followers' personality and the perception of transformational leadership: Further evidence for the similarity hypothesis. *British Journal of Management*, 21(2), 393-410.
- Fiedler, F. E. (1964). A contingency model of leadership effectiveness. In *Advances in experimental social psychology* (Vol. 1, pp. 149-190). Elsevier.
- Focht, A., & Ponton, M. (2015). Identifying primary characteristics of servant leadership: Delphi study. *International Journal of Leadership Studies*, 9(1).
- Food Corporation of Bhutan Limited. (2019). *Annual Report*. F. C. o. B. Limited.
- Fornell, C., & Larcker, D. F. (1981). Evaluating structural equation models with unobservable variables and measurement error. *Journal of marketing research*, 18(1), 39-50.
- Ghalley, K. (November 30 2022). *Civil and corporate employees need better diets and exercise*. Bhutan Broadcasting Services Limited. Retrieved 1 December 2022 from <http://www.bbs.bt/news/?p=178207>
- Ghasemi, A., & Zahediasl, S. (2012). Normality tests for statistical analysis: a guide for non-statisticians. *International journal of endocrinology and metabolism*, 10(2), 486. <https://www.ncbi.nlm.nih.gov/pmc/articles/PMC3693611/pdf/ijem-10-486.pdf>

- Gill, R. (2011). *Theory and practice of leadership*. Sage.
- Glynn, M. A., & DeJordy, R. (2010). Leadership through an organization behavior lens. *Handbook of leadership theory and practice*, 119-157.
- GNH Centre. (n.d). *What is GNH?* GNH Centre.  
<https://www.gnhcentrebhutan.org/what-is-gnh/>
- GNH, C. f. B. S. (November 2017). GNH of Business: Proceedings of the seventh International Conference on GNH. International Conference on GNH, Thimphu.
- Gooty, J., Gavin, M., Johnson, P. D., Frazier, M. L., & Snow, D. B. (2009). In the eyes of the beholder: Transformational leadership, positive psychological capital, and performance. *Journal of Leadership & Organizational Studies*, 15(4), 353-367.
- Gross National Happiness Commission. (2019). *Twelfth Five Year Plan: Main Document*. (978-99936-55-05-3). Thimphu: Royal Government of Bhutan
- Gyeltshen, C., Prasad, K., & Dema, S. (2020). Number of species in Bhutan. *Conservation Science and Practice*, 2(1).
- Gyem, P. (2019, May 9). *300 more taxis to switch to electric vehicles within 3 years*. Bhutan BroadCasting Service. <http://www.bbs.bt/news/?p=114044>
- Halpin, A. W. (1957). *Manual for the leader behavior description questionnaire*. Bureau of Business Research, College of Commerce and Administration, The ...
- Harris, E. G., & Fleming, D. E. (2017). The productive service employee: personality, stress, satisfaction and performance. *Journal of Services Marketing*.
- Hau, K. T., & Marsh, H. W. (2004). The use of item parcels in structural equation modelling: Non-normal data and small sample sizes. *British Journal of Mathematical and Statistical Psychology*, 57(2), 327-351.
- Henseler, J., Ringle, C. M., & Sarstedt, M. (2015). A new criterion for assessing discriminant validity in variance-based structural equation modeling. *Journal of the academy of marketing science*, 43(1), 115-135.
- Hersey, P., & Blanchard, K. H. (1997). Situational leadership. Dean's Forum,



- Hersey, P., Blanchard, K. H., & Natemeyer, W. E. (1979). Situational leadership, perception, and the impact of power. *Group & Organization Studies*, 4(4), 418-428.
- Hiebert, M., & Klatt, B. (2001). The encyclopedia of leadership. *A practical guide to*.
- House, R. J., & Mitchell, T. R. (1975). *Path-goal theory of leadership*.
- International Organization for Standardization. (2010). ISO 26000:2010(en) Guidance on social responsibility. In. Geneva: International Organization for Standardization (ISO).
- Karabati, S., Ensari, N., & Fiorentino, D. (2019). Job satisfaction, rumination, and subjective well-being: A moderated mediational model. *Journal of Happiness Studies*, 20(1), 251-268.
- Karatepe, O. M., Ozturk, A., & Kim, T. T. (2019). Servant leadership, organisational trust, and bank employee outcomes. *The Service Industries Journal*, 39(2), 86-108.
- Katz, R. L. (1974). Skills of an effective manager. *Harvard Business Review*, 52, 90-102.
- Katz, R. L. (2009). *Skills of an effective administrator*. Harvard Business Review Press.
- Keyes, C. L. (2002). The mental health continuum: From languishing to flourishing in life. *Journal of health and social behavior*, 207-222.
- Khan, N. A., Khan, A. N., Soomro, M. A., & Khan, S. K. (2020). Transformational leadership and civic virtue behavior: Valuing act of thriving and emotional exhaustion in the hotel industry. *Asia Pacific Management Review*, 25(4), 216-225.
- Kline, R. B. (2015). *Principles and practice of structural equation modeling*. Guilford publications.
- Koehn, D. (2005). Integrity as a business asset. *Journal of Business Ethics*, 58(1), 125-136.
- Koopmans, L. (2015). Individual work performance questionnaire instruction manual. *Amsterdam, NL: TNO Innovation for Life–VU University Medical Center*.

- Kör, B. (2016). The mediating effects of self-leadership on perceived entrepreneurial orientation and innovative work behavior in the banking sector. *SpringerPlus*, 5(1), 1-15.
- Kruger, M., & Dhiman, S. (2018). A Buddhist Theory of Organizational Leadership. *The Palgrave handbook of workplace spirituality and fulfillment*, 127.
- Kun, A., & Gadanez, P. (2019). Workplace happiness, well-being and their relationship with psychological capital: A study of Hungarian Teachers. *Current Psychology*, 1-15.
- Labour and Employment Act of Bhutan, (2007).  
[https://www.nab.gov.bt/assets/uploads/docs/acts/2014/Labour\\_and\\_Employment\\_Act,\\_2007\\_Dzo.pdf](https://www.nab.gov.bt/assets/uploads/docs/acts/2014/Labour_and_Employment_Act,_2007_Dzo.pdf)
- Lam, C. K., Huang, X., & Chan, S. C. (2015). The threshold effect of participative leadership and the role of leader information sharing. *Academy of management journal*, 58(3), 836-855.
- Lepeley, M.-T. (2017). Bhutan's gross national happiness: An approach to human centred sustainable development. *South Asian Journal of Human Resources Management*, 4(2), 174-184.
- Lewin, K., Lippitt, R., & White, R. K. (1939). Patterns of aggressive behavior in experimentally created "social climates". *The Journal of social psychology*, 10(2), 269-299.
- Lin, L. L. C., Irawan, A. P., Anggarina, P. T., & Yu-Wen, Z. (2020). The Relationship Between Servant Leadership and Job Satisfaction: The Mediating Effect of Job Empowerment.
- Luthan, F. (2011). Organizational Behavior Twelfth Edition. In: New York: The McGraw Hill Companies Inc.
- Luthans, F. (2002). Positive organizational behavior: Developing and managing psychological strengths. *Academy of Management Perspectives*, 16(1), 57-72.
- Luthans, F., Avolio, B. J., & Avey, J. A. (2007). Psychological capital questionnaire.
- Luthans, F., Avolio, B. J., Walumbwa, F. O., & Li, W. (2005). The psychological capital of Chinese workers: Exploring the relationship with performance. *Management and organization review*, 1(2), 249-271.

- Luthans, F., & Youssef-Morgan, C. M. (2017). Psychological capital: An evidence-based positive approach. *Annual review of organizational psychology and organizational behavior*, 4, 339-366.
- Luthans, F., & Youssef, C. M. (2004). Human, social, and now positive psychological capital management: Investing in people for competitive advantage.
- Luthans, F., & Youssef, C. M. (2007). Emerging positive organizational behavior. *Journal of Management*, 33(3), 321-349.
- Luthans, F., Youssef, C. M., & Avolio, B. J. (2007). *Psychological capital: Developing the human competitive edge*.
- Machiavelli, N. (2011). *The Prince* (T. Parks, Ed.). Penguin Books Ltd.
- Mafini, C., & Dlodlo, N. (2014). The linkage between work-related factors, employee satisfaction and organisational commitment: Insights from public health professionals. *SA Journal of Human Resource Management*, 12(1), 12.
- Malik, N., & Dhar, R. L. (2017). Authentic leadership and its impact on extra role behaviour of nurses: The mediating role of psychological capital and the moderating role of autonomy. *Personnel Review*.
- Manz, C. C. (1983). Improving performance through self-leadership. *National productivity review*, 2(3), 288-297.
- Manz, C. C. (1992). Self-leadership... the heart of empowerment. *The Journal for Quality and Participation*, 15(4), 80.
- Marczyk, G. R., DeMatteo, D., & Festinger, D. (2021). *Essentials of research design and methodology*. John Wiley & Sons, Inc.
- Mat, N., Jansriboot, P., & Mat, N. (2019). Big Five Personality, transformational leadership, psychological safety, and employee engagement of private sector employees in Southern Thailand. *Jurnal Pengurusan (UKM Journal of Management)*, 56.
- Matthews, R., & Ross, E. (2010). *Research methods: A practical guide for the social sciences*. Pearson Education Ltd.
- McCrae, R. R., & Costa Jr, P. T. (2008). The five-factor theory of personality.
- McCrae, R. R., & Costa, P. T. (2003). *Personality in adulthood: A five-factor theory perspective*. Guilford Press.

- Mekhum, W. (2020). Impact of Ethical Leadership on Organizational Outcomes through Mediation of Emotional Labor and Moderation of Followers' Personality Traits. *Systematic Reviews in Pharmacy*, 11(3).
- Millon, D. (1990). Theories of the Corporation. *Duke LJ*, 201.
- Ministry of Economic Affairs. (2020). *FDI Annual Report*. M. o. E. Affairs.
- Ministry of Education of Bhutan. (2020). *Annual Education Statistics*. R. G. o. Bhutan.
- Ministry of Foreign Affairs-Royal Government of Bhutan. (2017). *Press Release*. Royal Government of Bhutan. <https://www.mfa.gov.bt/?p=4996>
- Ministry of Health. (2020). *Annual Health Bulletin*. Thimphu: Policy and Planning Division, Ministry of Health
- Ministry of Health. (2021). *Annual Health Bulletin*.
- Ministry of Information and Communications-Royal Government of Bhutan. (24 June 2021). *Inauguration of Electric Vehicle Charging Station at Thimphu*. Ministry of Information and Communications-Royal Government of Bhutan. <https://www.moic.gov.bt/en/events-inauguration-of-electric-vehicle-charging-station-at-thimphu/>
- Mintzberg, H. (1983). The case for corporate social responsibility. *Journal of Business Strategy*.
- Mishra, P., Pandey, C. M., Singh, U., Gupta, A., Sahu, C., & Keshri, A. (2019). Descriptive statistics and normality tests for statistical data. *Annals of cardiac anaesthesia*, 22(1), 67. <https://www.ncbi.nlm.nih.gov/pmc/articles/PMC6350423/pdf/ACA-22-67.pdf>
- Montiel, I. (2008). Corporate social responsibility and corporate sustainability: Separate pasts, common futures. *Organization & Environment*, 21(3), 245-269.
- Mueller, D. C. (2020). *The corporation: investment, mergers, and growth*. Routledge.
- Mumford, M. D., Zaccaro, S. J., Connelly, M. S., & Marks, M. A. (2000). Leadership skills: Conclusions and future directions. *The Leadership Quarterly*, 11(1), 155-170.
- Muralidharan, E., & Pathak, S. (2018). Sustainability, transformational leadership, and social entrepreneurship. *Sustainability*, 10(2), 567.

- Myint, S. S., Leamprecha, N., Pooncharoen, N., & Rurkwararuk, W. (2016). An analysis of employee satisfaction of private banks in Myanmar. *International Business Management, 10*(2), 101-114.
- Nasser, F., & Wisenbaker, J. (2003). A Monte Carlo study investigating the impact of item parceling on measures of fit in confirmatory factor analysis. *Educational and psychological measurement, 63*(5), 729-757.
- National Biodiversity Centre. (2019). *National Biodiversity Statistics of Bhutan 2017: A Preliminary Baseline*. N. B. Centre.
- National Statistics Bureau. (2017a). *Bhutan Living Standards Survey Report R. G. o. B. National Statistics Bureau*.
- National Statistics Bureau. (2017b). *Poverty Analysis Report 2017* (978-99936-28-48-4).
- National Statistics Bureau. (October 2020). *Statistical Yearbook of Bhutan 2020*. N. S. Bureau.
- Nge, N., Rattanawiboonsom, V., Mahmood, A., & Rurkwararuk, W. (2015). The effect of resources relating to factors of logistics activities on performance benefits: Empirical Study of garment industries in Myanmar. *International Journal of Applied Business and Economic Research, 13*(9), 6703-6725.
- Nohria, N., & Khurana, R. (2010). *Handbook of leadership theory and practice*. Harvard Business Press.
- Norbu, C. (2019). *Connecting Shingkar and Gorgan: Our Challenges*. Kuensel. Retrieved 12 June 2021 from <https://kuenselonline.com/connecting-shingkar-and-gorgan-our-challenges/>
- Northouse, P. G. (2019). *Introduction to leadership: Concepts and practice*. Sage Publications.
- Northouse, P. G. (2021). *Leadership: Theory and practice*. SAGE Publications, Incorporated.
- Nunnally, J. C. (1994). *Psychometric theory 3E*. Tata McGraw-hill education.
- O'Brien, A., Read, G. J., & Salmon, P. M. (2020). Situation Awareness in multi-agency emergency response: Models, methods and applications. *International Journal of Disaster Risk Reduction, 48*, 101634.



- O'Keefe, D. F., Peach, J. M., & Messervey, D. L. (2019). The combined effect of ethical leadership, moral identity, and organizational identification on workplace behavior. *Journal of Leadership Studies*, 13(1), 20-35.
- Park, J. G., Kim, J. S., Yoon, S. W., & Joo, B.-K. (2017). The effects of empowering leadership on psychological well-being and job engagement: The mediating role of psychological capital. *Leadership & Organization Development Journal*.
- Patrul Rinpoche. (1998). *The words of my perfect teacher: A complete translation of a classic introduction to Tibetan Buddhism*. Rowman Altamira.
- Pem, D. (18 September 2021). Sex workers on the rise in Thimphu due to the Pandemic. *TheBhutanese*. <https://thebhutanese.bt/sex-workers-on-the-rise-in-thimphu-due-to-the-pandemic/>
- Peterson, T. O., & Van Fleet, D. D. (2004). The ongoing legacy of RL Katz. *Management decision*.
- Phuntsho, K. (2013). *The History of Bhutan*. Random House India.
- Phuntsho, K. (2016). Atsara: A Sacred-Profane Character. *Kuensel*. Retrieved July 21 2020, from <https://kuenselonline.com/atsara-a-sacred-profane-character/>
- Phuntsho, K. (2016, June 5). Tha Damtshig: Integrity. *Kuensel*.
- Pishva, N., Ghalehban, M., Moradi, A., & Hoseini, L. (2011). Personality and happiness. *Procedia-Social and Behavioral Sciences*, 30, 429-432.
- Podsakoff, P. M., MacKenzie, S. B., & Bommer, W. H. (1996). Transformational leader behaviors and substitutes for leadership as determinants of employee satisfaction, commitment, trust, and organizational citizenship behaviors. *Journal of Management*, 22(2), 259-298.
- Podsakoff, P. M., MacKenzie, S. B., Moorman, R. H., & Fetter, R. (1990). Transformational leader behaviors and their effects on followers' trust in leader, satisfaction, and organizational citizenship behaviors. *The Leadership Quarterly*, 1(2), 107-142.
- Pradhan, S., & Pradhan, R. K. (2015). An empirical investigation of relationship among transformational leadership, affective organizational commitment and contextual performance. *Vision*, 19(3), 227-235.

- Punia, V., Punia, B., & Dhull, I. (2004). An exploration of managerial skills and organizational climate in the educational services. *Journal of Services Research*, 4(1), 141.
- Rego, A., Sousa, F., Marques, C., & e Cunha, M. P. (2012). Authentic leadership promoting employees' psychological capital and creativity. *Journal of business research*, 65(3), 429-437.
- Rego, P., Lopes, M. P., & Nascimento, J. L. (2016). Authentic leadership and organizational commitment: The mediating role of positive psychological capital. *Journal of Industrial Engineering and Management (JIEM)*, 9(1), 129-151.
- Ribeiro, L. L., & Marinho, E. L. L. (2017). Gross National Happiness in Brazil: An analysis of its determinants. *Economia*, 18(2), 156-167.
- Rinzin, Y. C. (2020, April 11). BNBL recruited support staff who submitted forged documents: RAA. *Kuensel*. <https://kuenselonline.com/bnbl-recruited-support-staff-who-submitted-forged-documents-raa/>
- Robertson, I. T., & Cooper, C. L. (2010). Full engagement: the integration of employee engagement and psychological well-being. *Leadership & Organization Development Journal*.
- Roccas, S., Sagiv, L., Schwartz, S. H., & Knafo, A. (2002). The big five personality factors and personal values. *Personality and social psychology bulletin*, 28(6), 789-801.
- Roggio, R. E. (2011). Introduction: the dialogue of disciples. In M. Harvey & R. E. Riggio (Eds.), *Leadership Studies*. Edward Elgar Publishing Limited.
- Ronald, B. (2014). Comprehensive leadership review-literature, theories and research. *Advances in Management*, 7(5), 52.
- Rost, J. C. (1991). *Leadership for the twenty-first century*. Greenwood Publishing Group.
- Royal Audit Authority of Bhutan. *Audit Reports*. Royal Audit Authority of Bhutan. <http://www.bhutanaudit.gov.bt/index.php/audit-reports/>
- Royal Audit Authority of Bhutan. (2021). *Annual Audit Report 2020-2021*. R. A. A. o. Bhutan.

- Royal Charter for Druk Holding and Investments*. (2008). Druk Holding and Investments
- Royal Civil Service Commission. (2022). *Annual Report (July 2021-June 2022): State of the Royal Civil Service*. R. C. S. Commission. <https://www.rcsc.gov.bt/wp-content/uploads/2022/09/RCSC-Annual-Report-2021-22.pdf>
- Royal Government of Bhutan. (1999). *Bhutan 2020: A Vision for Peace, Prosperity and Happiness-II*. Thimphu: Royal Government of Bhutan,
- Rozi, A., Agustin, F., Hindriari, R., Rostikawati, D., & Akbar, I. R. (2020). The Effect Of Leadership On Employee Performance at PT. Stella Satindo In Jakarta. *HUMANIS (Humanities, Management and Science Proceedings)*, 1(1).
- Rus, C. L., Băban, A., Jesus, S. N. d., & Andrei, D. (2012). An analysis of the psychometric properties of the Psychological Capital Questionnaire-12. *Journal of Educational Sciences & Psychology*, 2(1).
- Sachs, J. D. (2011). The economics of happiness. *Economics*, 2011, 08-29.
- Salas-Vallina, A., Simone, C., & Fernández-Guerrero, R. (2020). The human side of leadership: Inspirational leadership effects on follower characteristics and happiness at work (HAW). *Journal of business research*, 107, 162-171.
- Samanta, I., & Lamprakis, A. (2018). Modern leadership types and outcomes: The case of Greek public sector. *Management: Journal of Contemporary Management Issues*, 23(1), 173-191.
- Santana-Cárdenas, S., Viseu, J., Lopez Nunez, M. I., & Neves de Jesus, S. (2018). Validity and reliability evidence of the Psychological Capital Questionnaire-12 in a sample of Mexican workers. *Anales de psicología*, 34(3), 562-570.
- Sattayaraksa, T., & Boon-itt, S. (2014). The roles of CEO transformational leadership on product innovation. *ISPIM Conference Proceedings*,
- Schreiber, J. B., Nora, A., Stage, F. K., Barlow, E. A., & King, J. (2006). Reporting structural equation modeling and confirmatory factor analysis results: A review. *The Journal of educational research*, 99(6), 323-338.
- Schyns, B., & Sanders, K. (2007). In the eyes of the beholder: Personality and the perception of leadership 1. *Journal of Applied Social Psychology*, 37(10), 2345-2363.

- Sebastian, I. (2015). Business and Corporate Social Responsibility in a Gross National Happiness Economy: Insights from Bhutan. Proceedings of the International Association for Business and Society,
- Sebastian, I. C. (2018). GNH in Business: A Business Approach that Goes Beyond Corporate Social Responsibility. *དཔལ་ འབྲུག་ ཞིབ་ འཇུག་ རྩེ་ བ།*, 259.
- Semedo, A. S., Coelho, A., & Ribeiro, N. (2019). Authentic leadership, happiness at work and affective commitment: An empirical study in Cape Verde. *European Business Review*.
- Sokoll, S. (2014). Servant leadership and employee commitment to a supervisor. *International Journal of Leadership Studies*, 8(2), 88-104.
- Soto, C. J., & John, O. P. (2017). Short and extra-short forms of the Big Five Inventory–2: The BFI-2-S and BFI-2-XS. *Journal of Research in Personality*, 68, 69-81.
- Stashevsky, S., Burke, R., Carmeli, A., Meitar, R., & Weisberg, J. (2006). Self-leadership skills and innovative behavior at work. *International journal of manpower*.
- Stelmokiene, A., & Endriulaitiene, A. (2015). Transformational leadership in perception of subordinates: Personality traits and social identification as predictors. *Baltic Journal of Management*.
- Stewart, G. L., Courtright, S. H., & Manz, C. C. (2011). Self-leadership: A multilevel review. *Journal of Management*, 37(1), 185-222.
- Stiglitz, J. E., Sen, A., & Fitoussi, J.-P. (2009). Report by the commission on the measurement of economic performance and social progress. In: Citeseer.
- Storey, J. (2004). *Leadership in organizations: Current issues and key trends*. Psychology Press.
- Storey, J. (2016). Changing theories of leadership and leadership development. In *Leadership in Organizations* (pp. 17-41). Routledge.
- Story, J. S., & Castanheira, F. (2019). Corporate social responsibility and employee performance: Mediation role of job satisfaction and affective commitment. *Corporate Social Responsibility and Environmental Management*, 26(6), 1361-1370.

- Sudsakorn, C., & Rattanawiboonsoom, V. (2018). Ethical Business Culture and its Impact on Unethical Behaviors in the Workplace: Conceptual Implications. *PSAKU International Journal of Interdisciplinary Research*, 7(1).
- Sweetman, D., Luthans, F., Avey, J. B., & Luthans, B. C. (2011). Relationship between positive psychological capital and creative performance. *Canadian Journal of Administrative Sciences/Revue Canadienne des Sciences de l'Administration*, 28(1), 4-13.
- Taber, K. S. (2018). The use of Cronbach's alpha when developing and reporting research instruments in science education. *Research in science education*, 48(6), 1273-1296.
- Tang, G., Cai, Z., Liu, Z., Zhu, H., Yang, X., & Li, J. (2015). The importance of ethical leadership in employees' value congruence and turnover. *Cornell Hospitality Quarterly*, 56(4), 397-410.
- Taştan, S. B. (2016). Psychological capital: A positive psychological resource and its relationship with creative performance behavior. *Anadolu Üniversitesi Sosyal Bilimler Dergisi*, 16(2), 101-118.
- The Bhutanese. (12 September 2012). *Dr David's critique of Bhutan's GNH story- 2*. The Bhutanese. <https://thebhutanese.bt/dr-davids-critique-of-bhutans-gnh-story-2/>
- The Bhutanese. (January 2023). 812 employees separated from DHI in 2022 with a 9.85% attrition rate. *The Bhutanese*. <https://thebhutanese.bt/812-employees-separated-from-dhi-in-2022-with-a-9-85-attrition-rate/>
- The Companies Act of Bhutan, (2016).
- The Permanent Mission of the Kingdom of Bhutan to the United Nations in New York. *About Bhutan: Gross National Happiness*. [https://www.mfa.gov.bt/pmbny/?page\\_id=166](https://www.mfa.gov.bt/pmbny/?page_id=166)
- the World Bank. (2021). *Data: Country Classification*. The World Bank. <https://datahelpdesk.worldbank.org/knowledgebase/articles/906519-world-bank-country-and-lending-groups#:~:text=For%20the%20current%202021%20fiscal,those%20with%20a%20GNI%20per>
- Tobgay, T. (2017). Keynote Address. GNH of Business: Proceeding of the seventh International Conference on Gross National Happiness, Thimphu.



- Tobgay, T. (2018). Buddhist Contributions to Human Development. *Journal of Bhutan Studies*, 38, 1-14.
- Truitt, W. B. (2006). *The corporation*. Greenwood Publishing Group.
- UN data. *UN data*. <https://data.un.org/>
- United Nations. *Sustainable Development*. <https://sdgs.un.org/goals>
- United Nations. (n.d). *Member States*. <https://www.un.org/en/about-us/member-states>
- United Nations Department of Economics and Social Affairs. (2012). *World economic situation and prospects 2012*. UN.
- United Nations Development Programme. (2020). *Human Development Index Ranking 2020*. <http://hdr.undp.org/en/content/latest-human-development-index-ranking>
- United Nations Statistics Division. (2021). *Popular statistical tables, country (area) and regional profiles* <https://data.un.org/default.aspx>
- Ura, K. (2005). Gross national happiness. *Sociological Bulletin*, 54(3), 603-607.
- Verma, R. (2019). The Eight Manifestations of GNH: Multiple Meanings of a Development Alternative. *Journal of Bhutan Studies*, 41.
- Wangchuk, R. (January 24 2023). Why are civil servants resigning? *Kuensel*. <https://kuenselonline.com/why-are-civil-servants-resigning/>
- Wangchuk, R. (July 8 2017). *ACC suspends top RICBL executives*. <https://kuenselonline.com/acc-suspends-top-ricbl-executives/>
- Warrick, D. (1981). Leadership styles and their consequences. *Journal of Experiential Learning and Simulation*, 3(4), 155-172.
- Williamson, O. E. (1981). The modern corporation: origins, evolution, attributes. *Journal of economic literature*, 19(4), 1537-1568.
- World Bank. *World Bank national accounts data, and OECD National Accounts data files*. [https://data.worldbank.org/indicator/NY.GDP.PCAP.CD?end=2019&locations=BH-OM-QA-AE-BT-AF-IN-PK-BD-NP-LK-MV&name\\_desc=false&start=2019&view=bar](https://data.worldbank.org/indicator/NY.GDP.PCAP.CD?end=2019&locations=BH-OM-QA-AE-BT-AF-IN-PK-BD-NP-LK-MV&name_desc=false&start=2019&view=bar)
- World Bank. (2021). *World Development Indicators* World Bank.
- Wright, T. A., & Bonett, D. G. (2007). Job satisfaction and psychological well-being as nonadditive predictors of workplace turnover. *Journal of Management*, 33(2), 141-160.

- Yang, C. (2014). Does ethical leadership lead to happy workers? A study on the impact of ethical leadership, subjective well-being, and life happiness in the Chinese culture. *Journal of Business Ethics*, 123(3), 513-525.
- Yang, Q., & Wei, H. (2017). Ethical leadership and employee task performance: Examining moderated mediation process. *Management decision*.
- Yangka, D., Rauland, V., & Newman, P. (2019). Carbon neutral policy in action: the case of Bhutan. *Climate Policy*, 19(6), 672-687.
- Yildiz, E. (2018). A case study on relationships between psychological capital, personality and organizational commitment. *International Journal of Business Administration*, 9(2), 99-122.
- Zangmo, T., Wangdi, K., & Phuntsho, J. (2017). *Proposed GNH of business*. Centre for Bhutan Studies & GNH.
- Zangmo, T., Wangdi, K., & Phuntsho, J. (2018). *GNH certification*. Centre for Bhutan Studies & GNH Thimphu.
- Zangpo, T. (January 14 2023). Bhutan aims USD 5B GDP by 2029, USD 10B by 2034. *Kuensel*. <https://kuenselonline.com/bhutan-aims-usd-5b-gdp-by-2029-usd-10b-by-2034/>



**APPENDIX**

มหาวิทยาลัยนครพนม

## APPENDIX A RESEARCH PROJECT DOCUMENTS

### Certificate of Approval from Human Research Ethics Committee, Naresuan University

AF 08-09/5.0

COA No. 047/2022

IRB No. P2-0421/2564



คณะกรรมการจริยธรรมการวิจัยในมนุษย์ มหาวิทยาลัยนเรศวร  
99 หมู่ 9 ตำบลท่าโพธิ์ อำเภอเมือง จังหวัดพิษณุโลก 65000 เบอร์โทรศัพท์ 05596 8642

#### หนังสือรับรองโครงการวิจัยครั้งแรก

คณะกรรมการจริยธรรมการวิจัยในมนุษย์ มหาวิทยาลัยนเรศวร ดำเนินการให้การรับรองโครงการวิจัยตามแนวทางหลักจริยธรรมการวิจัยในคนที่เป็นมาตรฐานสากล ได้แก่ Declaration of Helsinki, The Belmont Report, CIOMS Guideline และ International Conference on Harmonization in Good Clinical Practice หรือ ICH-GCP

**ชื่อโครงการ** : Intervening Effect of GNH in Corporation on the relationship between Leadership and Employee Performance in Bhutanese Corporations  
**ผู้วิจัยหลัก** : Mr.Karma Yezer  
**สังกัดหน่วยงาน** : คณะบริหารธุรกิจ เศรษฐศาสตร์และการสื่อสาร  
**วิธีทบทวน** : การพิจารณาแบบเร่งรัด (Expedited Review)  
**รายงานความก้าวหน้า** : ส่งรายงานความก้าวหน้าอย่างน้อย 1 ครั้ง/ปี หรือส่งรายงานฉบับสมบูรณ์ หากดำเนินโครงการเสร็จสิ้นก่อน 1 ปี

#### เอกสารรับรอง

1. AF 01-10 เวอร์ชัน 1.0 วันที่ 23 พฤศจิกายน 2564
2. AF 02-10 เวอร์ชัน 1.0 วันที่ 23 พฤศจิกายน 2564
3. AF 03-10 เวอร์ชัน 1.0 วันที่ 23 พฤศจิกายน 2564
4. AF 04-10 (สำหรับกลุ่ม Interview / สำหรับกลุ่ม Survey) เวอร์ชัน 2.0 วันที่ 19 มกราคม 2565
5. AF 05-10 เวอร์ชัน 2.0 วันที่ 19 มกราคม 2565
6. สรุปรายงานเพื่อการพิจารณาทางจริยธรรมการวิจัยในมนุษย์ เวอร์ชัน 2.0 วันที่ 19 มกราคม 2565
7. Thesis Proposal เวอร์ชัน 1.0 วันที่ 02 ธันวาคม 2564
8. PERSONAL DETAILS เวอร์ชัน 1.0 วันที่ 02 ธันวาคม 2564
9. Interview Guide/ Survey เวอร์ชัน 1.0 วันที่ 02 ธันวาคม 2564

10. Budget เวอร์ชัน 1.0 วันที่ 02 ธันวาคม 2564

ลงนาม



(ผู้ช่วยศาสตราจารย์ ดร.วนาวลัย ดาดี)

ประธานคณะกรรมการจริยธรรมการวิจัยในมนุษย์

วันที่รับรอง : 28 มกราคม 2565

วันหมดอายุ : 28 มกราคม 2566

ทั้งนี้ การรับรองนี้มีเงื่อนไขดังที่ระบุไว้ด้านหลังทุกข้อ (ดูด้านหลังของเอกสารรับรองโครงการวิจัย)





นักวิจัยทุกท่านที่ผ่านการรับรองจริยธรรมการวิจัยต้องปฏิบัติดังต่อไปนี้

1. ดำเนินการวิจัยตามที่ระบุไว้ในโครงการวิจัยอย่างเคร่งครัด
2. ใช้เอกสารแนะนำอาสาสมัคร ใบยินยอม (และเอกสารเชิญเข้าร่วมวิจัยหรือใบโฆษณาถ้ามี) แบบสัมภาษณ์ และหรือแบบสอบถาม เฉพาะที่มีตราประทับของคณะกรรมการจริยธรรมในมนุษย์ มหาวิทยาลัยนเรศวรเท่านั้น และส่งสำเนาเอกสารดังกล่าวที่ใช้กับผู้เข้าร่วมวิจัยจริงรายการแรกมาที่คณะกรรมการจริยธรรมการวิจัยในมนุษย์ เพื่อเก็บไว้เป็นหลักฐาน
3. รายงานเหตุการณ์ไม่พึงประสงค์ร้ายแรงที่เกิดขึ้นหรือการเปลี่ยนแปลงกิจกรรมวิจัยใด ๆ ต่อคณะกรรมการจริยธรรมการวิจัยในมนุษย์ มหาวิทยาลัยนเรศวร ภายในระยะเวลาที่กำหนดในวิธีดำเนินการมาตรฐาน (SOPs)
4. ส่งรายงานความก้าวหน้าต่อคณะกรรมการจริยธรรมการวิจัยในมนุษย์ ตามเวลาที่กำหนดหรือเมื่อได้รับการร้องขอ
5. หากการวิจัยไม่สามารถดำเนินการเสร็จสิ้นภายในกำหนด ผู้วิจัยต้องยื่นขออนุมัติใหม่ก่อน อย่างน้อย 1 เดือน
6. หากผู้วิจัยส่งรายงานความก้าวหน้าหลังใบรับรองหมดอายุ และยังไม่ได้ใบรับรองฉบับใหม่ ผู้วิจัยจะต้องหยุดดำเนินการวิจัยส่วนที่เกี่ยวข้องกับการรับอาสาสมัครใหม่ นับตั้งแต่หลังวันใบรับรองหมดอายุจนกว่าจะได้รับใบรับรองฉบับใหม่
7. หากการวิจัยเสร็จสมบูรณ์ผู้วิจัยต้องแจ้งปิดโครงการตามแบบฟอร์มของคณะกรรมการจริยธรรมในมนุษย์ มหาวิทยาลัยนเรศวร

\*รายชื่อของคณะกรรมการจริยธรรมการวิจัยในมนุษย์ (ชื่อและตำแหน่ง) ที่เข้าร่วมประชุม ณ วันที่พิจารณารับรองโครงการวิจัย (หากร้องขอล่วงหน้า)





## บันทึกข้อความ

ส่วนราชการ สำนักงานอธิการบดี กองการวิจัยและนวัตกรรม งานจัดการมาตรฐานฯ โทร.8642

ที่ อว 0603.01.13(1)/NU-IRB 0315 วันที่ 09 กุมภาพันธ์ 2565

เรื่อง ผลการประเมินด้านจริยธรรมการวิจัยในมนุษย์

เรียน Mr.Karma Yezer: นิสิตระดับปริญญาเอก (รองศาสตราจารย์ ดร.วิชญานัน รัตนวิบูลย์สม : อาจารย์ที่ปรึกษา) สังกัด: คณะบริหารธุรกิจ เศรษฐศาสตร์และการสื่อสาร

ตามที่ ท่านได้เสนอโครงการวิจัย เรื่อง Intervening Effect of GNH in Corporation on the relationship between Leadership and Employee Performance in Bhutanese Corporations (หมายเลขโครงการ : P2-0421/2564) มายังคณะกรรมการจริยธรรมการวิจัยในมนุษย์ มหาวิทยาลัยนเรศวร เพื่อขอรับพิจารณารับรองจริยธรรมการวิจัยในมนุษย์ นั้น

ในการนี้ คณะกรรมการจริยธรรมการวิจัยในมนุษย์ กลุ่มสาขาวิชาวิทยาศาสตร์เทคโนโลยี มนุษยศาสตร์และสังคมศาสตร์ ได้พิจารณาโครงการวิจัยดังกล่าวแล้ว และมีมติ รับรอง แบบเร่งรัด ซึ่งมีเอกสารที่รับรองดังนี้

1. AF 01-10 เวอร์ชัน 1.0 วันที่ 23 พฤศจิกายน 2564
2. AF 02-10 เวอร์ชัน 1.0 วันที่ 23 พฤศจิกายน 2564
3. AF 03-10 เวอร์ชัน 1.0 วันที่ 23 พฤศจิกายน 2564
4. AF 04-10 (สำหรับกลุ่ม Interview / สำหรับกลุ่ม Survey) เวอร์ชัน 2.0 วันที่ 19 มกราคม 2565
5. AF 05-10 เวอร์ชัน 2.0 วันที่ 19 มกราคม 2565
6. สรุปรายการเพื่อการพิจารณาทางจริยธรรมการวิจัยในมนุษย์ เวอร์ชัน 2.0 วันที่ 19 มกราคม 2565
7. Thesis Proposal เวอร์ชัน 1.0 วันที่ 02 ธันวาคม 2564
8. PERSONAL DETAILS เวอร์ชัน 1.0 วันที่ 02 ธันวาคม 2564
9. Interview Guide/ Survey เวอร์ชัน 1.0 วันที่ 02 ธันวาคม 2564
10. Budget เวอร์ชัน 1.0 วันที่ 02 ธันวาคม 2564

จึงเรียนมาเพื่อทราบ และพิจารณาดำเนินการตามข้อปฏิบัติสำหรับนักวิจัยที่ระบุไว้ด้านหลังของใบรับรอง

(ผู้ช่วยศาสตราจารย์ ดร.วนวัลย์ ดาดี)

ประธานคณะกรรมการจริยธรรมการวิจัยในมนุษย์

กลุ่มสาขาวิชาวิทยาศาสตร์เทคโนโลยี มนุษยศาสตร์และสังคมศาสตร์

มหาวิทยาลัยนเรศวร

**Approval of dissertation proposal by Graduate School, Naresuan University****Announcement****The Graduate School, Naresuan University  
Approval of Dissertation Proposal to Conduct Research  
No. 016/2022**

The Graduate School approved **Mr.Karma Yezer**, student ID: **63031087**; Doctor of Philosophy Program in Business Administration, to conduct research. The approved Dissertation proposal entitled: **“INTERVENING EFFECT OF GNH IN CORPORATION ON THE RELATIONSHIP BETWEEN LEADERSHIP AND EMPLOYEE PERFORMANCE IN BHUTANESE CORPORATIONS”** with Associate Professor **Dr.Vichayanan Rattanawiboonsom** as the thesis advisor.

Announced date: February 28, 2022

Handwritten signature of Krongkarn Chootip in black ink.

(Associate Professor Dr.Krongkarn Chootip)  
Dean of the Graduate School, Naresuan University



## APPENDIX B DATA COLLECTION INSTRUMENTS

### I. Survey Questionnaire

*Leadership, PsyCap, GNH in Corporations & Employee Performance*

#### Data\_1 (Survey): Leadership, GNH in Corporations, PsyCap & Employee Performance

*Sir/Madam*

*The information you provide through this survey shall form one part of the data sets for my research entitled "Intervening Effect of GNH in Corporation on the Relationship between Leadership and Employee Performance in Bhutanese Corporations". I request you to kindly provide genuine opinions; the confidentiality of your identity will be strictly maintained as per the university research norm. The "Naresuan University IRB informed Consent Form" is attached so that you can make informed decision for participation. The survey shall start after you agree to participate.*

*Thank You for your time!!!*

"The Naresuan University IRB Informed Consent Form" requires your consent to participate. If you agree, kindly indicate by ticking in the box before you proceed with the survey. If choose not to consent, the survey will be terminated.

- YES, I CONSENT to participate (Please continue to survey questions)  
 NO, I do not CONSENT to participate

#### Part 1

1. Gender [Tick (✓)]: •Male  •Female  •Other

2. Your position Level in the Organisation? (Please tick ✓ the appropriate one)

<i>Executive Level</i>	<input type="checkbox"/>	<i>Managerial Level</i>	<input type="checkbox"/>	<i>Supervisory Level</i>	<input type="checkbox"/>
<i>Operational Level</i>	<input type="checkbox"/>	<i>General Service Category (GSC)</i>			<input type="checkbox"/>

3. You are an employee of:

Druk Holding & Investment	<input type="checkbox"/>	Druk Green Power Corporation Ltd	<input type="checkbox"/>
Bhutan Power Corporation Ltd	<input type="checkbox"/>	Natural Resources Development Corp Ltd	<input type="checkbox"/>
Bhutan Telecom Ltd	<input type="checkbox"/>	Construction Development Corporation Ltd	<input type="checkbox"/>
Drukair Corporation Ltd	<input type="checkbox"/>		

#### Part 2

Please indicate the extent to which you agree or disagree with the following statements describing one-self, by CIRCLED the number [where 1=Strongly Disagree, 2=Disagree a little, 3=Neutral 4=Agree a little, 5=Agree Strongly]

	Statement describing one-self	Degree of Agreement				
	<b>I am Someone who usually:</b>					
1	Tends to be quiet	5	4	3	2	1
2	Is compassionate, has a soft heart	5	4	3	2	1
3	Tends to be disorganized	5	4	3	2	1
4	Worries a lot	5	4	3	2	1
5	Is fascinated by art, music, or literature	5	4	3	2	1
6	Is dominant, acts as a leader	5	4	3	2	1
7	Is sometimes rude to others	5	4	3	2	1
8	Has difficulty getting started on tasks	5	4	3	2	1
9	Tends to feel depressed, blue	5	4	3	2	1
10	Has little interest in abstract ideas	5	4	3	2	1



*Leadership, Psycap, GNH in Corporations & Employee Performance*

11	Is full of energy		5	4	3	2	1
12	Assumes the best about people		5	4	3	2	1
13	Is reliable, can always be counted on		5	4	3	2	1
14	Is emotionally stable, not easily upset		5	4	3	2	1
15	Is original, comes up with new ideas		5	4	3	2	1

**Part 3**

Below are statements that describe how you may think about yourself **RIGHT NOW**. **CIRCLE** the number to indicate your level of agreement or disagreement with each statement [where, **1=Strongly Disagree**, **2=Disagree**, **3=Somewhat Disagree**, **4=Somewhat agree**, **5=Agree**, **6=Strongly Agree**]

	Statement	Degree of Agreement					
		6	5	4	3	2	1
1	I feel confident in representing my work area in meetings with management	6	5	4	3	2	1
2	I feel confident contributing to discussions about organization's strategy	6	5	4	3	2	1
3	I feel confident presenting information to a group of colleagues	6	5	4	3	2	1
4	If I should find myself in a jam at work, I could think of many ways to get out of it	6	5	4	3	2	1
5	Right now I see myself as being pretty successful at work	6	5	4	3	2	1
6	I can think of many ways to reach my current work goals	6	5	4	3	2	1
7	At this time, I am meeting the work goals that I have set for myself	6	5	4	3	2	1
8	I can be "on my own," so to speak, at work if I have to	6	5	4	3	2	1
9	I usually take stressful things at work in stride	6	5	4	3	2	1
10	I can get through difficult times at work because I've experienced difficulty before	6	5	4	3	2	1
11	I always look on the bright side of things regarding my job	6	5	4	3	2	1
12	I'm optimistic about what will happen to me in the future as it pertains to work	6	5	4	3	2	1

**Part 4**

Considering the last one-year, rate your own performance based on the following statements. **CIRCLE** the number to indicate your response for each item. [Key: **0 = Never**, **1 = Seldom**, **2 = Occasionally**, **3 = Often**, **4 = Most Often**, **5=Always**]

	Performance Statement	Rating Score					
		In the last one year:					
1	I managed to plan my work so that I finished it on time	5	4	3	2	1	0
2	I kept in mind the work result I needed to achieve	5	4	3	2	1	0
3	I was able to set priorities	5	4	3	2	1	0
4	I was able to carry out my work efficiently	5	4	3	2	1	0
5	I managed my time well	5	4	3	2	1	0
6	On my own initiative, I started new task when my old tasks were completed	5	4	3	2	1	0
7	I took on challenging tasks when they were available	5	4	3	2	1	0
8	I worked on keeping my job-related knowledge up-to-date	5	4	3	2	1	0

*Leadership, Psycap, GNH in Corporations & Employee Performance*

9	I worked on keeping my work skills up-to-date	5	4	3	2	1	0
10	I came up with creative solutions for new problems	5	4	3	2	1	0
11	I took on extra responsibilities	5	4	3	2	1	0
12	I continually sought new challenges in my work	5	4	3	2	1	0
13	I actively participated in meetings and/or consultations	5	4	3	2	1	0
14	I complained about minor work-related issues at work	5	4	3	2	1	0
15	I made problems at work bigger than they were	5	4	3	2	1	0
16	I focused on the negative aspects of situation at work instead of the positive aspects	5	4	3	2	1	0
17	I talked to colleagues about the negative aspects of my work	5	4	3	2	1	0
18	I talked to people outside the organization about the negative aspects of my work	5	4	3	2	1	0

19	Please indicate your actual Performance based on last annual performance evaluation (tick ✓)				
	<49.9 <input type="checkbox"/>	50 to 64.9 <input type="checkbox"/>	65 to 79.9 <input type="checkbox"/>	80 to 89.9 <input type="checkbox"/>	90 to 100 <input type="checkbox"/>

**Part 5**

**1. Who is your immediate Supervisor/Manager/Leader that you report to?** (Please tick ✓)

<i>Unit Head</i>	<input type="checkbox"/>	<i>Division Head</i>	<input type="checkbox"/>	<i>Other</i>	<input type="checkbox"/>
<i>Section Head</i>	<input type="checkbox"/>	<i>Department Head</i>	<input type="checkbox"/>	<i>(If you have chosen other, please Specify)</i>	
.....					

**(D).** Read each of the following item carefully and think about how often your SUPERVISOR/MANAGER/LEADER engage in the described statements. **CIRCLE** the number to indicate your response for each item. [Key: 0 = Never, 1 = Seldom, 2 = Occasionally, 3 = Often, 4 = Most Often, 5 = Always]

		Statement Items (BEHAVIOUR)					
A	My Supervisor/Manager/Leader:	Rating Score					
1	Tells subordinates what they are supposed to do	5	4	3	2	1	0
2	Acts friendly with members of the group	5	4	3	2	1	0
3	Sets standards of performance for group members	5	4	3	2	1	0
4	Helps everyone in the group feel comfortable	5	4	3	2	1	0
5	Makes suggestions about how to solve problems	5	4	3	2	1	0
6	Responds favorably to suggestions made by others	5	4	3	2	1	0
7	Makes his or her perspective clear to others	5	4	3	2	1	0
8	Treats all subordinates fairly	5	4	3	2	1	0
9	Develops a plan of action for the group	5	4	3	2	1	0
10	Behaves in a predictable manner toward group members	5	4	3	2	1	0
11	Defines role responsibilities for each group member	5	4	3	2	1	0
12	Communicates actively with subordinate employees	5	4	3	2	1	0
13	Clarifies his or her own role within the group	5	4	3	2	1	0
14	Shows concern for the well-being of others	5	4	3	2	1	0
15	Provides a plan for how the work is to be done	5	4	3	2	1	0
16	Shows flexibility in making decisions	5	4	3	2	1	0

*Leadership, Psycap, GNH in Corporations & Employee Performance*

17	Provides criteria for what is expected of the group	5	4	3	2	1	0
18	Discloses thoughts and feelings to his/her subordinates	5	4	3	2	1	0
19	Encourages group members to do high-quality work	5	4	3	2	1	0
20	Helps employees get along with each other	5	4	3	2	1	0
<b>Statement Items (CHARACTER)</b>							
<b>My Supervisor/Manager/Leader:</b>		<b>Rating Score</b>					
1	Conducts personal life in ethical manner	5	4	3	2	1	0
2	Is clear about values and practices he/she preaches	5	4	3	2	1	0
3	Defines success not just by results but also how they are obtained	5	4	3	2	1	0
4	Can be trusted to do the things he/she says	5	4	3	2	1	0
5	Will never involve in corruption due to strong sense of integrity	5	4	3	2	1	0
6	Provides a good model for me to follow	5	4	3	2	1	0
<b>Statement Items (AWARENESS)</b>							
<b>C</b>	<b>My Supervisor/Manager/Leader:</b>	<b>Rating Score</b>					
1	Is interested in reading current affairs news	5	4	3	2	1	0
2	Keeps updated about the technological advancement	5	4	3	2	1	0
3	Explores technology for organizational efficiency	5	4	3	2	1	0
4	Stay well informed about relevant rules, regulations and legal issues	5	4	3	2	1	0
5	Is aware of the general situations (socio-political and economic trends) of the world	5	4	3	2	1	0

(II). The following is the description of certain Skills. Rate your SUPERVISOR/MANAGER/LEADER based on the given skill description from 1 to 10 where 1 being the Lowest and 10 represents the Highest skills.

<b>D</b>	<b>Skills of your Supervisor</b>	<b>Skills Rating Score</b>									
<b>Technical Skills</b>											
1	Technical skills for his/her position	10	9	8	7	6	5	4	3	2	1
2	Supervisory/managerial/leadership skills	10	9	8	7	6	5	4	3	2	1
3	Financial and mathematical Skills	10	9	8	7	6	5	4	3	2	1
4	Digital skills	10	9	8	7	6	5	4	3	2	1
5	Performance evaluation skills as per the guidelines	10	9	8	7	6	5	4	3	2	1
<b>Human Skills</b>											
1	Ability to make personal sacrifices to help others	10	9	8	7	6	5	4	3	2	1
2	Coordination of activities with team	10	9	8	7	6	5	4	3	2	1
3	Relevant use of cordiality/assertiveness/authority	10	9	8	7	6	5	4	3	2	1
4	Ability to understand the emotions of other colleagues	10	9	8	7	6	5	4	3	2	1
5	Skills to work well with colleagues around	10	9	8	7	6	5	4	3	2	1
6	Networking skills with external stakeholders	10	9	8	7	6	5	4	3	2	1
<b>Conceptual Skills</b>											
1	Inspiring others with his/her plans for the future	10	9	8	7	6	5	4	3	2	1
2	Understanding of where the organization is going	10	9	8	7	6	5	4	3	2	1
3	Ability to comprehend organization holistically	10	9	8	7	6	5	4	3	2	1
4	Identification of all the relevant options for the issue	10	9	8	7	6	5	4	3	2	1
5	Decision making skills	10	9	8	7	6	5	4	3	2	1

6	Re-evaluation of decisions and taking necessary interventions if required	10	9	8	7	6	5	4	3	2	1
---	---	----	---	---	---	---	---	---	---	---	---

**Part 6**

(I). Below are statements related to how you feel as a corporate employee. **CIRCLE** the number to indicate your level of agreement or disagreement with each statement [where, **1=Strongly Disagree**, **2=Disagree**, **3=Somewhat Disagree**, **4=Somewhat agree**, **5=Agree**, **6=Strongly Agree**]

	Statement	Degree of Agreement					
<b>Living Standard</b>							
1	I am satisfied with my pay and remuneration	6	5	4	3	2	1
2	Household income is enough to reasonably meet my family needs	6	5	4	3	2	1
3	I have enough essential things for happy life	6	5	4	3	2	1
4	Can afford certain optional insurance scheme(s)	6	5	4	3	2	1
5	I am satisfied with the conditions of my living standard	6	5	4	3	2	1
<b>Education &amp; Training</b>							
1	I am happy with the training & development opportunities	6	5	4	3	2	1
2	Employees are provided necessary short-term training	6	5	4	3	2	1
3	There are opportunities for employees to pursue long-term studies	6	5	4	3	2	1
4	I have adequate job-related skills as a result of trainings	6	5	4	3	2	1
5	Organisation carefully arranges appropriate employee up-skilling programme	6	5	4	3	2	1
<b>Health</b>							
1	My organization considers employee health and safety seriously	6	5	4	3	2	1
2	There is safe and secure physical working environment in my workplace	6	5	4	3	2	1
3	I feel constantly under physical strain	6	5	4	3	2	1
4	I feel constantly under mental strain						
5	I need to undergo medical treatment to function in my daily life	6	5	4	3	2	1
<b>Psychological Well-being</b>							
1	I am well satisfied about everything in my life	6	5	4	3	2	1
2	I frequently experience positive emotions making me happy at work						
3	I appreciate myself that I am playing useful part in my organization	6	5	4	3	2	1
4	I often experience negative feelings such as despair, anxiety or depression	6	5	4	3	2	1
<b>Concern for Culture</b>							
1	My organisation makes reasonable contributions for the promotion/preservation of culture	6	5	4	3	2	1
2	Our work ethics in this organization is influenced by 'Driglam Namzha' (Bhutanese Discipline)	6	5	4	3	2	1
3	My organisational culture is reflection of Bhutanese value of 'Tha Damsi' (Integrity & Sincerity)	6	5	4	3	2	1
4	I have a good knowledge of the culture, customs, traditions and history of Bhutan	6	5	4	3	2	1
5	I can use Dzongkha well for communication purposes	6	5	4	3	2	1

*Leadership, Psycap, GNH in Corporations & Employee Performance*

<b>Community Vitality</b>							
1	My organization often organizes social events/gatherings	6	5	4	3	2	1
2	There is a strong sense of corporate volunteerism in my organization	6	5	4	3	2	1
3	My organization has strong bonding with communities and other stakeholders	6	5	4	3	2	1
4	I have cordial relations with all my colleagues	6	5	4	3	2	1
5	As colleagues we support each other's joyful or sorrowful events	6	5	4	3	2	1
<b>Time Use</b>							
1	I get enough time for rest and sleep	6	5	4	3	2	1
2	I have time for recreational activities such as sports, hobbies and games	6	5	4	3	2	1
3	I can manage time for my household/family work	6	5	4	3	2	1
4	I can make my time for social interaction	6	5	4	3	2	1
<b>Good Governance</b>							
1	The organisation lives up to its core corporate values	6	5	4	3	2	1
2	There is equity and justice in the organisation based on the rule of law	6	5	4	3	2	1
3	There is strong system of transparency and accountability in the organisation	6	5	4	3	2	1
4	My organisation has mechanism for recognizing professionally efficient/effective performance	6	5	4	3	2	1
5	The organisation uses available fund and resources wisely with minimal waste	6	5	4	3	2	1
6	The innovation and creativity are highly encouraged in the organisation	6	5	4	3	2	1
7	Employee are able to participate in organizational governance process	6	5	4	3	2	1
<b>Concern for Environment</b>							
1	My organization is serious about natural environment more than mere legal compliance	6	5	4	3	2	1
2	The organization has environment policy statement as part of the business policy	6	5	4	3	2	1
3	My organization allocates reasonable fund annually for supporting environment conservation	6	5	4	3	2	1
4	The organization has proper waste disposal system in place						



*Leadership, Psycap, GNH in Corporations & Employee Performance*

(II)

1	Taking all things together, how happy would you say you are? (0=Not At all; 10=Very Happy)										
	0 <input type="checkbox"/>	1 <input type="checkbox"/>	2 <input type="checkbox"/>	3 <input type="checkbox"/>	4 <input type="checkbox"/>	5 <input type="checkbox"/>	6 <input type="checkbox"/>	7 <input type="checkbox"/>	8 <input type="checkbox"/>	9 <input type="checkbox"/>	10 <input type="checkbox"/>
2	How often do you experience sexual harassment in your workplace? (Please tick ✓)										
	Never <input type="checkbox"/>		Rarely <input type="checkbox"/>		Sometime <input type="checkbox"/>		Often <input type="checkbox"/>		Regularly <input type="checkbox"/>		
3	Did you suffer from any illness/injury in the last one month?										
	Yes <input type="checkbox"/>					No <input type="checkbox"/>					
4	If Yes, visited hospital/health service centre?										
	Admitted for overnight stay <input type="checkbox"/>			Availed OPD service <input type="checkbox"/>			Didn't visit any <input type="checkbox"/>				
5	On an average, how many hours do you sleep within the cycle of 24 hours?										
	6 hours or less <input type="checkbox"/>		7 to 8 hours <input type="checkbox"/>		9 to 10 hours <input type="checkbox"/>		More than 10 hours <input type="checkbox"/>				
6	In last six months, how many days in total did you attend short term training?										
	Never <input type="checkbox"/>	1-10 days <input type="checkbox"/>		11-20 days <input type="checkbox"/>		21-29 days <input type="checkbox"/>		1 to 6 months <input type="checkbox"/>			
7	After being employed here, have you availed any of the following long-term studies? (if relevant, can tick more than one option)										
	Not availed <input type="checkbox"/>		Diploma <input type="checkbox"/>		Bachelor <input type="checkbox"/>		Masters <input type="checkbox"/>		PhD <input type="checkbox"/>	Other <input type="checkbox"/>	
8	Rate Corporate Governance in your organization from 1 to 10 [where 1=Terrible; 10=Amazing]										
	1 <input type="checkbox"/>	2 <input type="checkbox"/>	3 <input type="checkbox"/>	4 <input type="checkbox"/>	5 <input type="checkbox"/>	6 <input type="checkbox"/>	7 <input type="checkbox"/>	8 <input type="checkbox"/>	9 <input type="checkbox"/>	10 <input type="checkbox"/>	
9	Rate the following Corporate Governance Values of your organization (tick ✓ only one for each row)										
	Integrity	Excellent <input type="checkbox"/>	Very Good <input type="checkbox"/>	Good <input type="checkbox"/>	Fair <input type="checkbox"/>	Poor <input type="checkbox"/>					
	Fairness/Equity	Excellent <input type="checkbox"/>	Very Good <input type="checkbox"/>	Good <input type="checkbox"/>	Fair <input type="checkbox"/>	Poor <input type="checkbox"/>					
	Responsibility	Excellent <input type="checkbox"/>	Very Good <input type="checkbox"/>	Good <input type="checkbox"/>	Fair <input type="checkbox"/>	Poor <input type="checkbox"/>					
	Transparency	Excellent <input type="checkbox"/>	Very Good <input type="checkbox"/>	Good <input type="checkbox"/>	Fair <input type="checkbox"/>	Poor <input type="checkbox"/>					
	Accountability	Excellent <input type="checkbox"/>	Very Good <input type="checkbox"/>	Good <input type="checkbox"/>	Fair <input type="checkbox"/>	Poor <input type="checkbox"/>					
	Team Work	Excellent <input type="checkbox"/>	Very Good <input type="checkbox"/>	Good <input type="checkbox"/>	Fair <input type="checkbox"/>	Poor <input type="checkbox"/>					
	Health & Safety	Excellent <input type="checkbox"/>	Very Good <input type="checkbox"/>	Good <input type="checkbox"/>	Fair <input type="checkbox"/>	Poor <input type="checkbox"/>					

**Thank You Once Again for your Time**

## II. Interview Guide

### Interview Guide

**Interviewee:**

**Title of the Study:**

**Intervening Effect of GNH in Corporation on the Relationship between Leadership and Employee Performance in Bhutanese Corporations**

Sl. No	Profiling Demographic information (Gender, Age, Position Title, Work experiences)
1	If you are to interpret GNH in Corporation, what would be your interpretation?
2	Is GNH applicable in Business and Business Corporations? As a Leader yourself, how did/do you apply in your organization?
3	What is your impression on Bhutanese Corporations? How should they involve more for socio-cultural, economic and ecological/environmental dimensions at employee, corporate and national level?
4	What is your opinion about the consequence of leadership in the employee Performance? Do you think Leadership matters for subordinate performance? Why?
5	What are the necessary qualities a Bhutanese business leader should possess, especially to qualify him/her as an exemplary Leader? What could be done to enhance current leadership in Bhutanese corporations, if at all there is a need for enhancement?
6	In your organization, what do you think about the Leadership generally? Do you think Leaders in the organization needs to improve? Why and how?
7	Do you believe that the organization reaps the benefit of employees' Psychological Capital? Can Leadership enhance employee Psychological Capital? How?
8	What is your perception about the composition of employees in terms of Personality?
9	Does employee personality matter for performance and how they can perceive happiness and job satisfaction?
10	Any additional comment or opinion not covered?

**Note:** This is just a guide. The researcher may ask further questions based on this guide as conversation deepens.

## APPENDIX C DESCRIPTIVE STATISTICS

### Reliability Statistics of Leadership & Self-rated employee performance

Variable	Sub variable/Dimensions	Pre-test	Actual	N of Items	
		data	Data		
		Cronbach's Alpha			
Leadership (Independent Variable)	Behaviour	1. Task-Orientation	0.95	0.95	10
		2. People-Orientation	0.94	0.94	10
	Character	Character	0.97	0.89	6
		Awareness	Awareness	0.91	0.91
	Skills	1. Technical Skills	0.92	0.91	5
		2. Human Skills	0.95	0.95	6
3. Conceptual Skills		0.97	0.97	6	
Self-Rated Work Performance (Dependent Variable)	1. Task Performance	0.85	0.78	5	
		2. Contextual Performance	0.88	0.87	8
	3. Counter productive Work Behaviour	0.81	0.72	5	

### Reliability Statistics of GNH in Corporation and Psychological Capital

Variable	Dimensions	Pre-test data	Actual	N of Items
		Cronbach's Alpha		
<b>GNH in Corporation</b>	1. Living Standard	0.85	0.87	5
	2. Training & Education	0.88	0.85	5
	3. Health	0.69	0.68	5
	4. Psychological Wellbeing	0.67	0.56	4
	5. Concern for Culture	0.67	0.73	5
	6. Community Vitality	0.8	0.74	5
	7. Time Use	0.91	0.86	4
	8. Good Governance	0.93	0.91	7
	9. Concern for Environment	0.83	0.79	4
<b>Psychological Capital</b>	1. Efficacy	0.8	0.79	3
	2. Hope	0.72	0.7	4
	3. Resilience	0.59	0.51	3
	4. Optimism	0.47	0.62	2

### Skewness & Kurtosis values of Employee Performance and Leadership

Variable/Dimensions	N	Mean	Skewness		Kurtosis	
			Statistic	SE	Statistic	SE
Task Performance	511	4.3	-.99	.108	.87	.216
Contextual Performance	511	3.9	-.70	.108	.11	.216
Counter-productive Behavior (Recoded)	511	4.1	-1.33	.108	2.32	.216
<b>Self-Rated Performance</b>	511	4.1	-.66	.108	.49	.216
<b>Actual Performance</b>	511	4.2	-.848	.108	1.481	.216
Task Orientation	511	3.8	-1.10	.108	.85	.216
People Orientation	511	3.8	-1.12	.108	.90	.216
<b>Behavior</b>	511	3.8	-1.10	.108	.81	.216
Ethical Commitment	511	3.7	-.90	.108	.52	.216
Authentic Influence	511	3.7	-.97	.108	.40	.216
Self-Belief	511	3.6	-.75	.108	-.30	.216
<b>Character</b>	511	3.7	-.92	.108	.58	.216
Technological Awareness	511	3.7	-.94	.108	.49	.216
Socio-eco-politico Awareness	511	3.7	-.87	.108	.60	.216
Legal & Policy Awareness	511	4.0	-1.03	.108	.81	.216
<b>Awareness</b>	511	3.8	-1.01	.108	.94	.216
Technical Skills	511	3.9	-1.09	.108	1.310	.216
Human Skills	511	3.9	-1.08	.108	.806	.216
Conceptual Skills	511	2.3	-1.09	.108	1.010	.216
<b>Skills</b>	511	3.4	-1.12	.108	1.125	.216
<b>Overall Leadership</b>	511	3.6	-1.06	.108	.952	.216



**Skewness & Kurtosis values of Psychological Capital, GNH in Corporation and Personality**

Variables/Dimensions	N	Mean	Skewness		Kurtosis	
			Statistic	SE	Statistic	SE
Efficacy	511	5.1	-1.23	.108	4.04	.216
Hope	511	5.0	-0.97	.108	2.68	.216
Resilience	511	4.8	-0.61	.108	0.52	.216
Optimism	511	5.0	-1.26	.108	3.49	.216
<b>PSYCHOLOGICAL CAPITAL</b>	511	5.0	-0.66	.108	1.86	.216
Living Standard	511	4.2	-0.80	.108	0.56	.216
Training and Education	511	3.9	-0.60	.108	-0.18	.216
Health	511	4.4	-0.47	.108	0.06	.216
Psychological Wellbeing	511	4.4	-0.60	.108	1.03	.216
Concern for Culture	511	4.8	-0.68	.108	0.77	.216
Community Vitality	511	4.7	-0.68	.108	0.66	.216
Time Use	511	4.6	-1.19	.108	2.62	.216
Good Governance	511	4.4	-1.08	.108	1.83	.216
Concern for Environment	511	4.7	-1.06	.108	2.68	.216
<b>GNH IN CORPORATION</b>	511	4.5	-0.71	.108	1.06	.216
Agreeableness	511	3.5	-0.05	.108	0.20	.216
Conscientiousness	511	3.9	-0.24	.108	-0.84	.216
Negative emotionality	511	3.3	-0.33	.108	0.24	.216
Open-Mindedness	511	3.6	0.19	.108	-0.35	.216
<b>PERSONALITY</b>	511	3.5	0.08	.108	-0.12	.216

### Corporation wise Mean values of Leadership

Corporation	Statistics	Leadership Dimension				Leadership
		S	A	C	B	
<b>DHIL</b>	Mean	3.466	4.550	4.600	4.590	<b>4.302</b>
	SD	0.926	0.966	0.690	0.565	0.597
<b>DGPCL</b>	Mean	3.349	3.653	3.557	3.679	<b>3.559</b>
	SD	0.683	0.856	1.075	0.974	0.824
<b>BPCL</b>	Mean	3.342	3.809	3.634	3.790	<b>3.644</b>
	SD	0.704	1.014	1.058	0.973	0.856
<b>BTL</b>	Mean	3.490	3.927	3.820	3.957	<b>3.799</b>
	SD	0.598	0.834	0.910	0.952	0.731
<b>NRDCL</b>	Mean	3.367	3.709	3.636	3.833	<b>3.636</b>
	SD	0.866	1.332	1.326	1.084	1.074
<b>DrukAir</b>	Mean	3.455	3.903	3.801	3.942	<b>3.775</b>
	SD	0.739	1.114	1.081	1.059	0.949
<b>CDCL</b>	Mean	3.124	3.576	3.455	3.591	<b>3.436</b>
	SD	0.715	0.837	1.116	1.001	0.839
<b>Total</b>	Mean	3.361	3.780	3.654	3.796	<b>3.648</b>
	N	511	511	511	511	511
	SD	0.711	0.992	1.079	0.988	0.863

**Note:** S=Skills; A=Awareness; C=Character; B=Behaviour

### Item wise Leadership Behavior Descriptive statistics

Leadership Behavior	My Supervisor/Manager/Leader:	Mean	SD
Task Oriented Behavior	Tells subordinates what they are supposed to do	3.892	1.154
	Sets standards of performance for group members	3.820	1.173
	Makes suggestions about how to solve problems	3.847	1.249
	Makes his or her perspective clear to others	3.881	1.158
	Develops a plan of action for the group	3.714	1.282
	Defines role responsibilities for each group member	3.906	1.132
	Clarifies his or her own role within the group	3.785	1.256
	Provides a plan for how the work is to be done	3.748	1.262
	Provides criteria for what is expected of the group	3.636	1.208
	Encourages group members to do high-quality work	3.949	1.272
People Oriented Behavior	Acts friendly with members of the group	4.121	1.117
	Helps everyone in the group feel comfortable	3.951	1.300
	Responds favorably to suggestions made by others	3.722	1.275
	Treats all subordinates fairly	3.984	1.313
	Behaves in a predictable manner toward group members	3.687	1.269
	Communicates actively with subordinate employees	3.977	1.181
	Shows concern for the well-being of others	3.875	1.274
	Shows flexibility in making decisions	3.577	1.314
Discloses thoughts and feelings to his/her subordinates	3.010	1.412	
Helps employees get along with each other	3.847	1.248	

### Item wise Leadership Skills Descriptive statistics

Leadership Skills	Skills of Supervisor/Manager/Leader	*Mean	SD
Technical Skills	Technical skills required for his/her position	8.020	1.736
	Supervisory/managerial/leadership skills	7.706	2.016
	Financial and mathematical Skills	7.791	1.768
	Digital skills	7.677	1.835
	Performance evaluation skills as per the guidelines	7.992	1.712
Human Skills	Ability to make personal sacrifices to help others	7.491	2.148
	Coordination of activities with team	7.763	2.037
	Relevant use of cordiality/assertiveness/authority	7.751	1.739
	Ability to understand the emotions of other colleagues	7.628	2.074
	Skills to work well with colleagues around	7.834	1.999
Conceptual Skills	Networking skills with external stakeholders	7.804	1.891
	Inspiring others with his/her plans for the future	7.448	2.054
	Understanding of where the organization is going	8.004	1.868
	Ability to comprehend organization holistically	7.736	1.822
	Identification of all the relevant options for the issue	7.659	1.810
	Decision making skills	7.740	2.079

**Note:** \* Unlike other leadership dimension items which were measured on the scale of 0 to 5, leadership skills were rated from 0 to 10. However, the ratings were scaled down to 5 for uniformity and for the analysis

**Leadership ‘Character’ and ‘Awareness’ item wise statistics**

<b>Leadership Dimension</b>	<b>My Supervisor/Manager/Leader:</b>	<b>Mean</b>	<b>SD</b>
Leadership Character	Conducts personal life in ethical manner	3.638	1.317
	Is clear about values and practices he/she preaches	3.667	1.214
	Defines success not just by results but also how they are obtained	3.507	1.224
	Can be trusted to do the things he/she says	3.744	1.258
	Will never involve in corruption due to strong sense of integrity	3.710	1.635
	Provides a good model for me to follow	3.658	1.380
Leadership Awareness	Is interested in reading current affairs news	3.710	1.167
	Keeps updated about the technological advancement	3.714	1.216
	Explores technology for organizational efficiency	3.591	1.249
	Stay well informed about relevant rules, regulations and legal issues	3.961	1.089
	Is aware of the general situations (socio-political and economic trends) of the world	3.740	1.106



### GNH Pillar 1 item-wise statistics

<b>Pillar 1: Sustainable and Equitable Social and Economic Development</b>		
<b>Item Statements</b>	<b>Mean</b>	<b>SD</b>
I am satisfied with my pay and remuneration	4.40	1.208
Household income is enough to reasonably meet my family needs	4.03	1.235
I have enough essential things for happy life	4.08	1.179
Can afford certain optional insurance scheme(s)	4.24	1.085
I am satisfied with the conditions of my living standard	4.43	1.073
I am happy with the training & development opportunities	3.74	1.356
Employees are provided necessary short-term training	3.96	1.33
There are opportunities for employees to pursue long-term studies	3.55	1.461
I have adequate job-related skills as a result of trainings	4.28	1.161
Organisation carefully arranges appropriate employee up-skilling programme	3.79	1.244
My organization considers employee health and safety seriously	4.73	1.117
There is safe and secure physical working environment in my workplace	4.76	0.989
I feel constantly under physical strain	3.11	1.188
I feel constantly under mental strain	3.14	1.306
I need to undergo medical treatment to function in my daily life	2.29	1.196

### GNH Pillar 2 item-wise statistics

<b>Pillar 2: Preservation and Promotion of Culture</b>		
<b>Item Statements</b>	<b>Mean</b>	<b>SD</b>
My organisation makes reasonable contributions for the promotion/preservation of culture	4.56	.927
Our work ethics in this organization is influenced by 'Driglam Namzha' (Bhutanese Etiquette/Discipline)	4.58	1.041
My organisational culture is reflection of Bhutanese value of 'Tha Damtsi' (Integrity & Sincerity)	4.89	.958
I have a good knowledge of the culture, customs, traditions and history of Bhutan	4.91	.687
I can use Dzongkha well for communication purposes	5.24	.733
I am well satisfied about everything in my life	4.16	1.113
I frequently experience positive emotions making me happy at work	4.48	.892
I appreciate myself that I am playing useful part in my organization	5.16	.766
I often experience negative feelings such as despair, anxiety or depression	3.06	1.326
I get enough time for rest and sleep	4.67	.986
I have time for recreational activities such as sports/hobbies	4.42	1.091
I can manage time for my household/family work	4.76	.852
I can make my time for social interaction	4.66	.818
My organization often organizes social events/gatherings	3.96	1.283
There is a strong sense of corporate volunteerism in my organization	4.38	1.030
My organization has strong bonding with communities and other stakeholders	4.70	1.006
I have cordial relations with all my colleagues	5.28	.666
As colleagues we support each other's joyful or sorrowful events	5.21	.798

### GNH Pillar 3 & 4 item-wise statistics

<b>Pillar 3: Good Governance</b>		
<b>Item Statement</b>	<b>Mean</b>	<b>SD</b>
The organisation lives up to its core corporate values	4.81	.845
There is equity and justice in the organisation based on the rule of law	4.37	1.162
There is strong system of transparency and accountability in the organisation	4.35	1.115
My organisation has mechanism for recognizing professionally efficient/effective performance	4.38	1.020
The organisation uses available fund and resources wisely with minimal waste	4.45	1.030
The innovation and creativity are highly encouraged in the organisation	4.60	1.083
Employees are able to participate in organizational governance process	4.16	1.025
<b>Pillar 4: Conservation of Environment</b>		
My organization is serious about natural environment more than mere legal compliance	4.54	.997
The organization has environment policy statement as part of the business policy	4.77	.962
My organization allocates reasonable fund annually for supporting environment conservation	4.43	.997
The organization has proper waste disposal system in place	4.95	.975

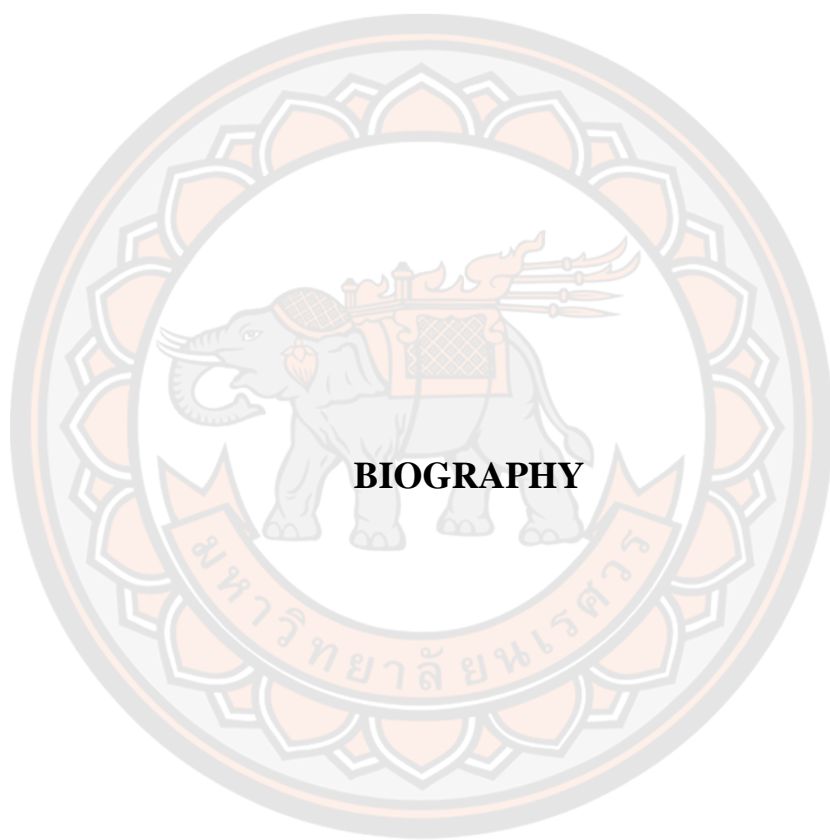

**BIOGRAPHY**

มหาวิทยาลัยนครพนม

## BIOGRAPHY

<b>Name-Surname</b>	Karma Yezer
<b>Date of Birth</b>	11 October 1986
<b>Current Workplace</b>	Royal University of Bhutan (Gedu College of Business Studies)
<b>Current Position</b>	Lecturer
<b>Work Experience</b>	2019-present Lecturer, Gedu College of Business Studies, Royal University of Bhutan 2015-2018 Associate Lecturer, Gedu College of Business Studies, Royal University of Bhutan 2010-2014 Assistant Lecturer, Gedu College of Business Studies, Royal University of Bhutan
<b>Education Background</b>	2017 MHRM. (Human Resource Management) University of Madras, India 2008 BA. (Honors), Delhi University, India
<b>Publication</b>	1. Ligori, T. A. A., Suresh, N., Khan, S. A., Rabgay, T., & Yezer, K. (2022). The mediating effect of university image on the relationship between curriculum and student satisfaction: an empirical study of the Royal University of Bhutan. <i>International Journal of Pluralism and Economics Education</i> , 13(2), 192-208. 2. Yezer, K. (July 2021). Teaching Module through Cases for Developing Students' Analytical Thinking: An Action Research. <i>Elixir International Journal</i> , 156 (2021); 3. Mathews, J., Yezer, K., & Antony, KM. (June 2020). Organizational Architecture of Human Resources. <i>Bhutan Journal of Business and Management</i> , 3(1), 279-301 4. Prepared and submitted Employee Satisfaction Report and CDCL HRD Master Plan (2020-2030) to Construction Development Corporation Limited (CDCL) in 2020 as one of the four consultant team members.